Operating Instructions

Bedienungsanleitung

Mode d'emploi

Instrucciones de manejo

Istruzioni d'uso



SevenEasy™
pH Meter S20

METTLER TOLEDO

Italiano

Español

Français

Deutsch

English

Contents

1.	Introduction	3
2.	Safety measures	3
	Measures for your protection	3
	Measures for operational safety	3
3.	Description of the instrument	4
	3.1 Display	4
	3.2 Keypad	5
4.	Installation	6
5.	Sample Measurement	8
	5.1 pH measurement	8
	5.2 mV measurement	8
	5.3 Settings	8
	5.3.1 ATC	8
	5.3.2 MTC	8
	5.3.3 Data output	8
6.	Calibration	9
	6.1 Settings	9
	6.2 Select a fixed buffer group	9
	6.3 Set a user-defined buffer group	9
	6.4 Calibration	10
	6.4.1 1-Point calibration	10
	6.4.2 2-Point calibration	10
	6.4.3 3-Point calibration	10
7.	Self-Diagnosis	11
8.	Optional battery operation	11
9.	Error messages	12
10.	Maintenance	13
	10.1 Meter maintenance	13
	10.2 Electrode maintenance	13
	10.3 Disposal	13
11.	Accessories	14
12.	Specifications	15
13.	Quick Guide	16
14.	Buffer sets	17

1. Introduction

SevenEasy – an instrument which offers far more than simple pH measurement, without breaking your budget. An instrument with so many advantages:

- SevenEasy saves you time. The user interface is designed in such a logical way that you will no longer need to consult your user manual.
- SevenEasy can be battery operated. Thanks to this option you can now easily move your instrument from one working area to another even when no power supply is available.
- SevenEasy has added value. Our Service Option allows for regular Equipment Qualification which will improve the reliability and accuracy of your instrument.

2. Safety measures

Measures for your protection



- Never work in an environment subject to explosion hazards! The housing of the instrument is not gas tight (explosion hazard due to spark formation, corrosion caused by the ingress of gases).



- When using chemicals and solvents, comply with the instructions of the producer and the general lab safety rules!

Measures for operational safety



- Have the instrument serviced only by METTLER TOLEDO Service!
- Always wipe off splashed liquids immediately! The instrument is not waterproof.
- Use batteries of the specified type only. Otherwise, proper operation cannot be guaranteed.
- Exclude the following environmental influences:
 - powerful vibrations,
 - direct sunlight,
 - atmospheric humidity greater than 80%,
 - corrosive gases present,
 - temperatures below 5 °C and above 40 °C,
 - powerful electric or magnetic fields!

3. Description of the instrument

3.1 Display

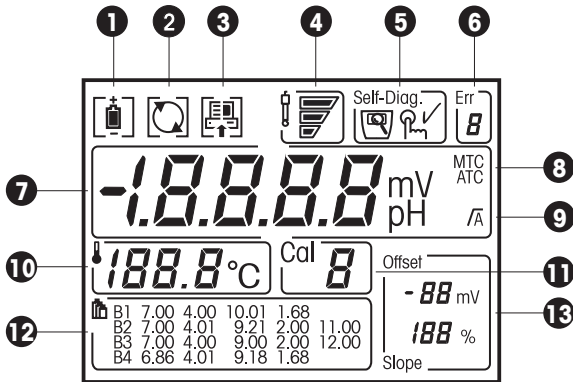

1 Battery status

2 Auto-off override during battery operation

3 Data transfer to PC/Printer

4 Electrode condition



slope: 95 - 105 %
offset: \pm (0 - 15) mV
Electrode is in
good condition



slope: 90 - 94 %
offset: \pm (15 - 35) mV
Electrode needs
cleaning



slope: 85 - 89 %
offset: \pm (>35) mV
Electrode is faulty

5 Meter self-diagnosis



Self-diagnosis
indicator



Indication to
press key



Self-diagnosis
passed

6 Error index

7 pH/mV-reading

8 Auto/Manual Temperature compensation

9 Endpoint stability/autom endpoint



Endpoint stability



Auto endpoint

10 Temperature

11 Calibration point

12 Buffer groups





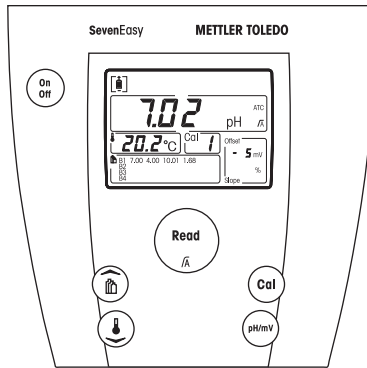





13 Electrode offset and slope

3.2 Keypad



Press & release

Press & hold for 2 seconds

	Meter on/off	Auto-off override during battery operation	
	<ul style="list-style-type: none"> - Start or endpoint measurement - Return to measurement mode - Store entered value 	Turn auto endpoint on/off	
	<ul style="list-style-type: none"> - Start calibration - Confirm buffer group selected 	Displaying the buffers used for the calibration	
	Switch between pH- and mV measurement mode	Data transfer to PC or printer	
	<ul style="list-style-type: none"> - Select calibration buffer groups - Increase value during setting 		
	<ul style="list-style-type: none"> - Set MTC-temperature - Decrease value during setting 		
	Start meter self-diagnosis Self-Diag. 		

4. Installation

1. Unpack the meter, power adapter, electrode, electrode arm and other accessories. Keep the calibration certificate in a safe place.
2. Make sure the power adapter matches your local power supply. If not, please contact your vendor.
3. Install the electrode stand

- The electrode stand can be used stand alone or it can be attached to the instrument. The electrode arm is placed in one of the three positions on the base. If the electrode stand is used stand alone it is recommended to use the middle position.

The appropriate lid needs to be removed. Use the fixing screw supplied to tighten the connection. Installation is finished if the electrode stand is used stand alone.

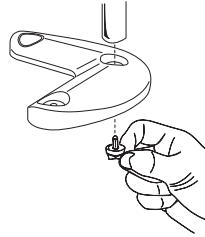

- If the electrode stand is attached to the instrument, place the base in such a way that the free wing of the base faces away from you. The appropriate lid needs to be removed. The electrode stand can be used on the left or right hand side.

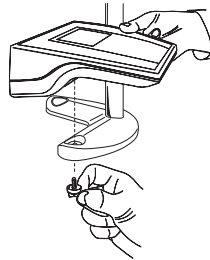

- Adjust the tension knob as required.

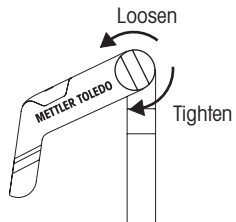

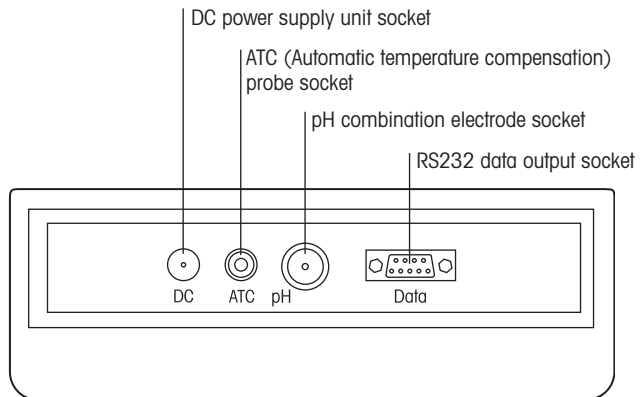



4. Disconnect the shorting clip from the pH socket.
5. Connect the electrode. If you are using an electrode with a built-in temperature probe, connect the other lead to the ATC socket.
6. If you are using a separate temperature probe, connect it to the ATC socket.
7. Connect the power supply unit to the DC socket.

5. Sample Measurement

5.1 pH measurement

Place electrode in sample and press  to start the measurement: the decimal point flashes. The display shows the pH of the sample. The automatic endpoint **A** is the meter's default setting. When the sensor output has stabilized, the display freezes automatically, and **A** appears. The automatic endpoint algorithm is 0.1 mV per 5 seconds.

By pressing and holding the  key, you can switch between auto and manual endpoint mode. To manually endpoint a measurement, press , the display freezes and **∟** appears.

5.2 mV measurement

To perform a mV measurement, follow the same procedure as for pH measurement. To see the mV value during pH measurement, simply press .

5.3 Settings

5.3.1 ATC

For better accuracy, we recommend the use of either a built-in or a separate temperature probe. When a temperature probe is used, the symbol **ATC** and the sample temperature are displayed.



5.3.2 MTC

When the meter does not detect a temperature probe, it automatically switches to manual temperature compensation mode, and **MTC** appears.

To set the MTC temperature, press  to start, use  and  to increase or decrease the value to the temperature of your sample. Press the  key to confirm your setting. The default setting is 25 °C.

5.3.3 Data output

If a PC or printer is connected, every endpointed reading is sent to PC or printed through the RS232 interface.

By pressing and holding the  key  appears. The meter sends out a reading every second until it has endpointed.

6. Calibration

6.1 Settings

The SevenEasy pH meter allows you to perform 1-, 2- and 3-point calibrations. If you select your calibration buffer group from the 4 fixed groups defined in the meter, the buffers are automatically recognized during calibration (auto buffer recognition).



The 4 fixed buffer groups are:

B1: (25 °C)	7.00	4.00	10.01	1.68	
B2: (25 °C)	7.00	4.01	9.21	2.00	11.00
B3: (20 °C)	7.00	4.00	9.00	2.00	12.00
B4: (25 °C)	6.86	4.01	9.18	1.68	





You can also follow the buffer setting procedure below to define your own buffer group, but in this case the auto buffer recognition will not work during calibration.



6.2 Select a fixed buffer group

Press the  key, the current buffer group starts blinking. If the current setting is the user-defined group, the blank frame blinks.

Use the  or  key to select other groups in the upper or lower position. When the desired buffer group blinks, press  to confirm your selection.

6.3 Set a user-defined buffer group

In step 6.2, when the blank frame blinks, press  to start setting. The meter displays your current temperature value setting and the dot and frame blink (default temperature is 25 °C). Use  or  key to change the value. Press  to store the value and continue.

After setting the temperature value, the meter displays the current setting of the first calibration buffer (default value 4.00). Use  or  key to change the value. Press  to store the value and continue.

After setting the first calibration buffer, press  to start setting the next point.

The procedure is the same as for the 1st point. You can set up to 3 user-defined calibration buffers. When you have completed your settings, press  to exit.

Note

When using a user-defined buffer group in the calibration, the screen will display the buffer value you set. Make sure that you are using the correct buffer. You should also keep the buffer temperature at the set value. When a temperature probe is used, if the temperature measured differs by more than 1 degree from the set value, Err 5 appears.

6.4 Calibration

6.4.1 1-Point calibration

Place the electrode in a calibration buffer and press .

The SevenEasy pH meter automatically endpoints when calibrating. To manually endpoint, press . The meter displays and freezes the relevant buffer value, and shows the electrode offset.

To return to sample measurement, press .

6.4.2 2-Point calibration

Step 1 Perform the first point calibration as described in "1-Point calibration".

Step 2 Use distilled water to rinse the electrode.

Step 3 Place the electrode in the next calibration buffer and press .

The SevenEasy pH meter automatically endpoints when calibrating. To manually endpoint, press . The meter displays and freezes the relevant buffer value, updates the electrode offset and shows its slope.

To return to sample measurement, press .

6.4.3 3-Point calibration

Perform the same steps as in the "2-Point calibration", then repeat steps 2 and 3 for the third point calibration.



Note

The use of a temperature probe or electrode with a built-in temperature probe is recommended. If you use the MTC mode, you should keep all buffer and sample solutions at the same set temperature.

To ensure the most accurate pH readings, you should perform a calibration regularly.







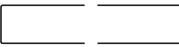

By pressing and holding the  key, the number and type of buffers used for the calibration are displayed. The buffer values appear in alternating order.

7. Self-Diagnosis

Press and hold  and  simultaneously until the meter self-diagnosis icon  appears.

The meter displays the full screen first, then each icon blinks one after the other. The final step is to check that the keys function. This requires the user's cooperation.

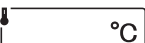
When the icon  blinks, depending on the flashing content, press the corresponding key within 5 seconds.



- When  flashes, press the  key;
- When  flashes, press the  key;
- When  flashes, press the pH/mV key;
- When  flashes, press the  key;
- When  flashes, press the  key.

When self-diagnosis is completed, a tick  icon appears. If the self-diagnosis fails, turn to "9. Error Messages" in these operating instructions for the proper action(s).

8. Optional battery operation

The SevenEasy pH meter offers optional battery operation. Install 4 AA batteries in the rear of the meter. If the power adapter is disconnected, the meter is operated by battery and the  icon appears.

When the batteries lose power, the meter displays .

During battery operation, the meter has an auto-off function - if no key is pressed during the next 10 minutes, the meter will automatically switch off to save battery power. To override the auto-off function, press and hold  key for 2 seconds until  appears.

9. Error messages

Error 1 - Offset out of range

Make sure you have the correct buffer and that it is fresh.
Clean or replace the electrode.

Error 2 - Slope out of range

Make sure you have the correct buffer and that it is fresh.
Clean or replace the electrode.

Error 3 - Meter cannot recognize the buffer

Make sure you have the correct buffer and that it is fresh.
Check whether the buffer is used more than once in the calibration.

Error 4 - Data entry error in setting the user-defined buffer

When entering the user-defined buffer value, the meter doesn't accept a value whose pH differs by less than 1 pH unit from other pre-set values. Re-enter a value.

Error 5 - ATC measured temperature is different from the user-defined value.

Keep the buffer or sample at the set temperature or change the temperature setting.

Error 6 - the measured buffer temperature is out of the range (5... 50°C)

Keep the buffer temperature within the range.

Error 7, (----) - mV value out of range

Make sure the electrode is connected.
If no electrode is connected, place the shorting clip in the socket.

Error 8 - pH measuring value out of range

Check if the electrode wetting cap is removed and if the electrode is properly connected and placed in a sample solution.

Error 9 - Self-diagnosis failed

Repeat self-diagnosis process and make sure that you press the correct keys while the  icon is blinking. If Err 9 still appears, call METTLER TOLEDO service.

10. Maintenance

10.1 Meter maintenance

There are no user-replaceable parts in the meter or power supply unit. Do not remove the covers. The SevenEasy needs no maintenance except for an occasional wipe with a damp cloth. The housing is made of ABS/PC which is attacked by some organic solvents, such as toluene, xylene and methyl ethyl ketone. It is good laboratory practice to wipe away any spillage immediately.

10.2 Electrode maintenance

Make sure the electrode is always kept filled with the appropriate filling solution. For maximum accuracy, any filling solution that may have "crept" and encrusted the outside of the electrode should be removed with distilled water.

Always store the electrode properly and do not allow it to dry out.

If the electrode slope value falls rapidly, or if the response becomes sluggish or inaccurate, the following procedures may help. Try them one by one in the order given.

1. Degrease the membrane with cotton wool soaked in either acetone or soap solution.
2. Soak the tip of the electrode in 0.1 M HCl overnight.
3. If a protein build-up has occurred, remove deposits by soaking electrode in a HCl/pepsin solution (Order Nr. 51340068).
4. If a silver sulfide contamination has occurred, remove deposits by soaking electrode in a thiourea solution (Order Nr. 51340070).

Note

Cleaning and filling solutions should be handled with the same care given to toxic or corrosive substances.

10.3 Disposal



In conformance with the European Directive 2002/96/ EC on Waste Electrical and Electronic Equipment (WEEE) this device may not be disposed of in domestic waste. This also applies to countries outside the EU, per their specific requirements.

Please dispose of this product in accordance with local regulations at the collecting point specified for electrical and electronic equipment.

If you have any questions, please contact the responsible authority or the distributor from which you purchased this device.

Should this device be passed on to other parties (for private or professional use), the content of this regulation must also be related.

Thank you for your contribution to environmental protection.

11. Accessories

	Order Nr.
Electrode arm complete	51302820
Guide to pH measurement	51300047
Guide to conductivity and dissolved oxygen	51724716
Guide to ion selective measurement	51300075
pH 4.01 buffer sachets, 30 x 20mL	51302069
pH 4.01 buffer solution, 6 x 250mL	51340058
pH 7.00 buffer sachets, 30 x 20mL	51302047
pH 7.00 buffer solution, 6 x 250mL	51340060
pH 9.21 buffer sachets, 30 x 20mL	51302070
pH 9.21 buffer solution, 6 x 250mL	51300194
pH 10.01 buffer sachets, 30 x 20mL	51302079
pH 10.01 buffer solution, 6 x 250mL	51340231
InLab®410, three-in-one pH sensor, glass, refillable	52000118
InLab®412, laboratory pH sensor, glass, refillable	52000112
InLab®413, rugged 3-in-1 pH sensor, PEEK shaft, ATC	52000100
InLab®420, special pH sensor with PTFE junction	52000113
HCl/Pepsin solution (removes protein contamination)	51340068
Thiourea solution (removes silver sulfide contamination)	51340070
Reactivation solution for pH electrodes	51340073

12. Specifications

	pH	mV	Temperature		
Measurement Range	0.00 - 14.00	± 1999	-5 ... 105 °C		
Resolution	0.01	1	0.1 °C		
Relative Accuracy	± 0.01	± 1	± 0.5 °C		
pH-calibration	1, 2, or 3 points				
Isopotential Point	7.00 pH				
Calibration Buffer	B1: (25 °C)	7.00	4.00	10.01	1.68
	B2: (25 °C)	7.00	4.01	9.21	2.00 11.00
	B3: (20 °C)	7.00	4.00	9.00	2.00 12.00
	B4: (25 °C)	6.86	4.01	9.18	1.68
	B5: User-defined				
Temperature Compensation	-5 ... 105 °C automatic or manual				
Display	Liquid crystal				
Outputs	RS232 serial, Baud rate: 1200 Data bit: 8 Stop bit: 1 Parity: none				
pH input	Impedance > 10 ¹² Ohm				
Ambient Conditions	Ambient temperature:	5 °C ... 40 °C			
	Relative humidity:	5 % ... 80 % (non condensing)			
	Installation category:	II			
	Pollution degree:	2			
Size/Weight	180 x 180 x 65 mm / 0.61 kg				
Materials	Housing:	ABS, PC enforced			
	Electrode stand:	ABS, PC enforced			
	Membrane keypad:	Polyester			
Power Requirements	The SevenEasy pH meter is supplied with an appropriate power supply unit:				
	- USA:	120 V / 60 Hz, 10 VA, 9 V DC			
	- Europe:	230 V / 50 Hz, 10 VA, 9 V DC			
	- UK:	240 V / 50 Hz, 10 VA, 9 V DC			
	- Japan:	110 V / 50 Hz, 10 VA, 9 V DC			
	- Australia:	240 V / 50 Hz, 10 VA, 9 V DC			
	- China:	220 V / 50 Hz, 10 VA, 9 V DC			
	- Battery (optional):	4 x AA (LR6)			

Note

The SevenEasy pH meter should only be used with the power supply unit supplied, or with batteries.

13. Quick Guide

1. Prepare Electrode

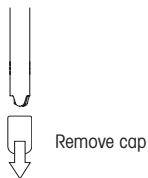

2. 1-Point Calibration

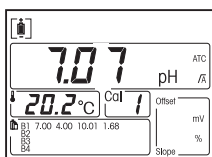
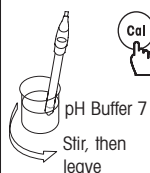

auto endpoint or

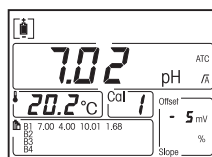

3. Rinse Electrode

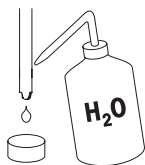

4. 2 or 3-Point Calibration

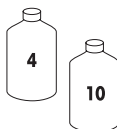

Repeat step 2 when carrying out a 2 or 3-point calibration, then rinse

5. Measure sample

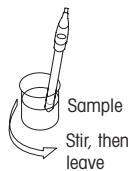

auto endpoint or

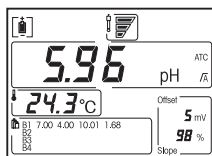

6. Rinse Electrode

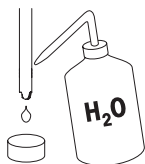

7. Store Electrode



14. Buffer sets

SevenEasy pH Meter automatically corrects for setting temperature using the values shown in the tables:

Buffer Set 1 (ref. 25 °C) MT US

5	7.09	4.00	10.25	1.67
10	7.06	4.00	10.18	1.67
15	7.04	4.00	10.12	1.67
20	7.02	4.00	10.06	1.68
25	7.00	4.00	10.01	1.68
30	6.99	4.01	9.97	1.68
35	6.98	4.02	9.93	1.69
40	6.97	4.03	9.89	1.69
45	6.97	4.04	9.86	1.70
50	6.97	4.06	9.83	1.71

Buffer Set 2 (ref. 25 °C) MT Europa

5	7.09	4.01	9.45	2.02	11.72
10	7.06	4.00	9.38	2.01	11.54
15	7.04	4.00	9.32	2.00	11.36
20	7.02	4.00	9.26	2.00	11.18
25	7.00	4.01	9.21	2.00	11.00
30	6.99	4.01	9.16	1.99	10.82
35	6.98	4.02	9.11	1.99	10.64
40	6.97	4.03	9.06	1.98	10.46
45	6.97	4.04	9.03	1.98	10.28
50	6.97	4.06	8.99	1.98	10.10

Buffer Set 3 (ref. 20 °C) Merck

5	7.07	4.04	9.16	2.01	12.41
10	7.05	4.02	9.11	2.01	12.26
15	7.02	4.01	9.05	2.00	12.10
20	7.00	4.00	9.00	2.00	12.00
25	6.98	4.01	8.95	2.00	11.88
30	6.98	4.01	8.91	2.00	11.72
35	6.96	4.01	8.88	2.00	11.67
40	6.95	4.01	8.85	2.00	11.54
45	6.95	4.01	8.82	2.00	11.44
50	6.95	4.00	8.79	2.00	11.33

Buffer Set 4 (ref. 25 °C) Japan JIS

5	6.95	4.00	9.40	1.67
10	6.92	4.00	9.33	1.67
15	6.90	4.00	9.28	1.67
20	6.88	4.00	9.22	1.68
25	6.86	4.01	9.18	1.68
30	6.85	4.02	9.14	1.68
35	6.84	4.02	9.10	1.69
40	6.84	4.04	9.07	1.69
45	6.83	4.05	9.04	1.70
50	6.83	4.06	9.01	1.71

Inhalt

1.	Einleitung	3
2.	Sicherheitsmassnahmen	3
	Massnahmen zu Ihrem Schutz	3
	Massnahmen zur Betriebssicherheit	3
3.	Beschreibung des Gerätes	4
	3.1 Anzeige	4
	3.2 Tastatur	5
4.	Installation	6
5.	Probenmessung	8
	5.1 pH-Messung	8
	5.2 mV-Messung	8
	5.3 Einstellungen	8
	5.3.1 ATC	8
	5.3.2 MTC	8
	5.3.3 Datenausgang	8
6.	Kalibrierung	9
	6.1 Einstellungen	9
	6.2 Auswahl einer vordefinierten Puffergruppe	9
	6.3 Einstellen einer vom Anwender definierten Puffergruppe	9
	6.4 Kalibrierung	10
	6.4.1 Einpunkt-Kalibrierung	10
	6.4.2 Zweipunkt-Kalibrierung	10
	6.4.3 Dreipunkt-Kalibrierung	10
7.	Selbsttest	11
8.	Alternativer Batteriebetrieb	11
9.	Fehlermeldungen	12
10.	Wartung	13
	10.1 Wartung des Gerätes	13
	10.2 Wartung der Elektrode	13
	10.3 Entsorgung	13
11.	Zubehör	14
12.	Technische Daten	15
13.	Quick Guide	16
14.	Puffergruppen	17

1. Einleitung

SevenEasy – ein Gerät, welches Ihre Ansprüche weit über die reine pH-Messung erfüllt ohne Ihr Budget unnötig zu beanspruchen. Ein Gerät, das viele Vorteile bringt:

- Die Benutzeroberfläche ist so gestaltet, dass sämtliche Bedienungsschritte selbsterklärend ausgeführt werden können. Somit sparen Sie viel Zeit.
- Dank der Batteriespeisung kann das Gerät schnell auf einem anderen Labortisch oder sogar in einem anderen Labor installiert und eingesetzt werden. Auch an Orten, wo der Netzanschluss nicht verwendet werden kann.
- Servicedienstleistungen ermöglichen die regelmässige Qualifizierung Ihrer Geräte und erhöhen die Verfügbarkeit und die Genauigkeit Ihres Gerätes.

2. Sicherheitsmassnahmen

Massnahmen zu Ihrem Schutz



- Nicht in explosionsgefährdeter Umgebung arbeiten! Das Gehäuse des Geräts ist nicht gasdicht. Sonst besteht Explosionsgefahr durch Funkenbildung und/oder Korrosionsgefahr durch eindringende Gase.



- Beachten Sie bei der Verwendung von Chemikalien und Lösemitteln die Vorschriften des Herstellers und die allgemeinen Sicherheitsregeln im Labor!

Massnahmen zur Betriebssicherheit



- Lassen Sie das Gerät nur vom METTLER TOLEDO Service warten!
- Trocknen Sie Flüssigkeits-Spritzer jeweils ab! Das Gerät ist nicht wasserdicht.
- Nur Batterien des spezifizierten Typs verwenden. Ein einwandfreies Funktionieren ist sonst nicht gewährleistet.
- Schliessen Sie folgende Umwelteinflüsse aus:
 - starke Vibrationen,
 - direkte Sonneneinstrahlung,
 - Luftfeuchtigkeit über 80%,
 - korrosive Gasatmosphäre,
 - Temperaturen unter 5 °C und über 40 °C,
 - starke elektrische oder magnetische Felder!

3. Beschreibung des Gerätes

3.1 Anzeige

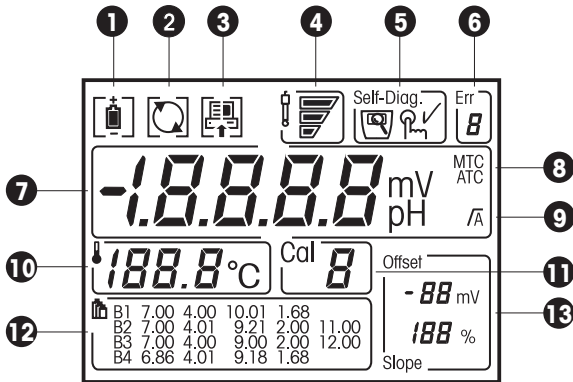

1 Batteriezustand

2 Ausserkraftsetzung des automatischen Ausschaltens während des Batteriebetriebs

3 Datenübertragung zum PC/Drucker

4 Zustand der Elektrode



Steilheit: 95 - 105 %
 Offset: \pm (0-15) mV
 Guter Zustand
 der Elektrode



Steilheit: 90 - 94 %
 Offset: \pm (15 - 35) mV
 Elektrode benötigt
 Reinigung



Steilheit: 85 - 89 %
 Offset: \pm (>35) mV
 Elektrode ist defekt

5 Gerät Selbsttest



Selbsttest-
 Anzeige



Aufforderung zum
 Tasten drücken



Selbsttest
 bestanden

6 Fehlernummer

7 pH/mV-Messung

8 Autom./Manueller Temperaturengleich

9 Endpunkt Stabilität/autom. Endpunkt

∩ Endpunkt-Stabilität A Autom. Endpunkt

10 Temperatur

11 Kalibrierungspunkt

12 Puffergruppen

13 Offset und Steigung der Elektrode

3.2 Tastatur

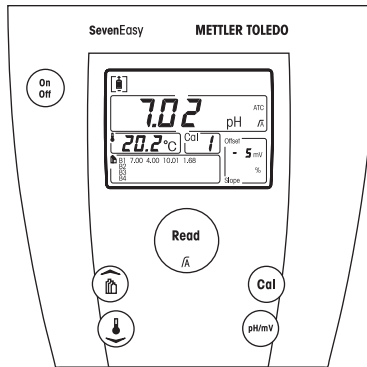

Drücken & loslassen

Drücken und während 2 Sek. gedrückt halten

	Meter ein/aus	Deaktivieren des automatischen Ausschaltens mit Batteriebetrieb
	<ul style="list-style-type: none"> - Anfangs- oder Endpunktmessung - Zurück zum Messmodus - Eingegebenen Wert speichern 	Autom. Endpunkt ein-/ausschalten
	<ul style="list-style-type: none"> - Kalibrierung beginnen - Ausgewählte Puffergruppe bestätigen 	Anzeige der für die Kalibrierung verwendeten Puffer
	Zwischen pH- und mV-Messmodus hin und her schalten	Datenübertragung zum PC oder Drucker
	<ul style="list-style-type: none"> - Auswahl der Kalibrierungspuffergruppen - Wert während der Einstellung heraufsetzen 	
	<ul style="list-style-type: none"> - MTC-Temperatur einstellen - Wert während der Einstellung herabsetzen 	
	Autotest beginnen Self-Diag.	

4. Installation

1. Packen Sie das Gerät, den Netzadapter, die Elektrode, den Elektrodenarm und das andere Zubehör aus. Bewahren Sie das Kalibrierungszertifikat an einem sichern Ort auf.
2. Vergewissern Sie sich, dass der Netzadapter mit ihrer Netzspeisung übereinstimmt. Wenn nicht, setzen Sie sich mit Ihrer METTLER TOLEDO Vertretung in Verbindung.
3. Installieren sie den Elektrodenarm.

- Der Elektrodenhalter kann alleine stehend verwendet werden oder am Gerät montiert werden. Der Elektrodenarm wird in eine der drei Positionen auf dem Sockel platziert. Es wird empfohlen, das mittlere Loch zu benutzen, falls der Elektrodenhalter alleine stehend verwendet wird. Zuerst muss die entsprechende Abdeckung entfernt werden. Fixieren Sie die Verbindung mittels der mitgelieferten Befestigungsschraube. Die Installation ist beendet, wenn der Elektrodenhalter alleine stehend verwendet werden soll.

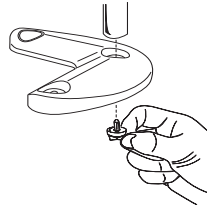

- Falls der Elektrodenhalter am Gerät befestigt werden soll, setzen Sie das Gerät so auf den Sockel, dass der frei stehende Flügel des Sockels nach hinten schaut. Zuerst muss die entsprechende Abdeckung entfernt werden. Der Elektrodenhalter kann links oder rechts des Geräts befestigt werden.

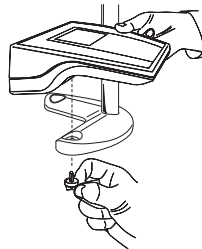

- Verstellen sie den Spannungsdrehknopf nach Bedarf.

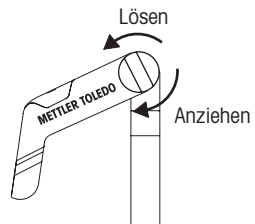

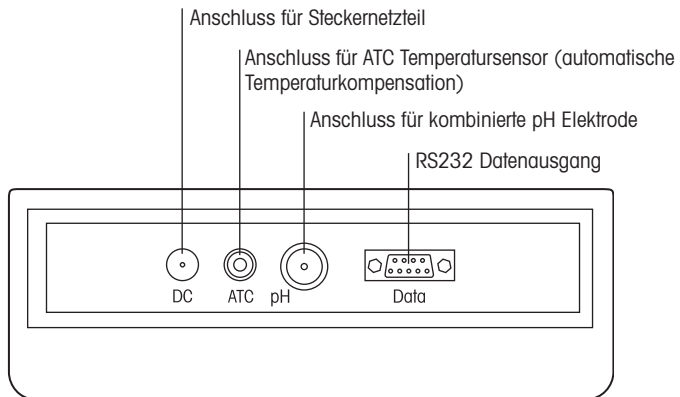

4. Entfernen Sie die Kurzschlussklammer vom pH-Anschluss.
5. Verbinden Sie die Elektrode. Wenn Sie eine Elektrode mit integrierter Temperatursonde verwenden, verbinden Sie das andere Kabel mit dem ATC-Anschluss.
6. Wenn Sie eine separate Temperatursonde verwenden, verbinden Sie ihn mit dem ATC-Anschluss.
7. Verbinden Sie die Netzeinheit mit dem Gleichstromanschluss (DC).



5. Probenmessung

5.1 pH-Messung

Stellen Sie die Elektrode in die Probe und drücken Sie  um die Messung zu beginnen – der Dezimalpunkt blinkt.

Auf der Anzeige steht der aktuelle pH-Wert der Probe. Der automatische Endpunkt **A** ist die Grundeinstellung des Geräts. Wenn sich das Signal des Sensors stabilisiert hat, bleibt die Anzeige stehen und **√A** erscheint.

Der Algorithmus der automatischen Endpunkterkennung ist 0,1 mV pro 5 Sekunden.

Durch anhaltendes Drücken der Taste  können Sie zwischen automatischem oder manuellem Endpunkformat hin und her schalten. Um den Endpunkt für eine Messung manuell einzugeben, drücken Sie die Taste . Die Anzeige erstarrt und **√** erscheint.

5.2 mV-Messung

Um eine mV-Messung durchzuführen, gehen Sie wie bei einer pH-Messung vor. Um den mV-Wert zu sehen müssen Sie die Taste  drücken.





5.3 Einstellungen

5.3.1 ATC

Für eine höhere Genauigkeit empfehlen wir die Verwendung einer integrierten oder separaten Temperatursonde. Wenn eine Temperatursonde verwendet wird, erscheint das Symbol **ATC** und die aktuelle Messtemperatur auf der Anzeige.



5.3.2 MTC

Wenn das Gerät feststellt, dass keine Temperatursonde angeschlossen ist, wechselt es automatisch in den manuellen Temperaturkompensationsmodus über, und **MTC** erscheint auf der Anzeige.

Um die MTC-Temperatur einzustellen, drücken Sie . Benützen Sie  und , um den Temperaturwert nach unten oder oben zu verschieben. Bestätigen Sie Ihre Eingabe durch Drücken der Taste . Die Grundeinstellung ist 25 °C.

5.3.3 Datenausgang

Wenn ein PC oder Drucker angeschlossen ist, wird jede Endpunktmessung über den RS232-Anschluss an den PC oder Drucker übermittelt.

Durch Drücken und Halten der Taste  erscheint  in der Anzeige. Das Gerät übermittelt eine Messung pro Sekunde, bis der Endpunkt erreicht ist.

6. Kalibrierung

6.1 Einstellungen

Das SevenEasy pH-Meter ermöglicht Ein-, Zwei- und Dreipunkt-Kalibrierungen. Wenn Sie Ihre Kalibrierungspuffergruppe aus den vier im Gerät vorgegebenen Gruppen auswählen, so wird die automatische Puffergruppenerkennung während der Kalibrierung durchgeführt.

Die 4 vordefinierten Puffergruppen sind:

B1: (25 °C)	7,00	4,00	10,01	1,68	
B2: (25 °C)	7,00	4,01	9,21	2,00	11,00
B3: (20 °C)	7,00	4,00	9,00	2,00	12,00
B4: (25 °C)	6,86	4,01	9,18	1,68	





Mit der unten beschriebenen Puffereinstellung können Sie Ihre eigene Puffergruppe definieren. Während der Kalibrierung ist die automatische Puffererkennung nicht aktiv.



6.2 Auswahl einer vordefinierten Puffergruppe

Drücken Sie die Taste  und die aktuelle Puffergruppe beginnt zu blinken. Ist die aktuelle Gruppe eine vom Anwender definierte Gruppe, so blinkt der leere Rahmen.

Benützen Sie die Tasten  oder , um andere Gruppen in der oberen oder unteren Position auszuwählen. Wenn die gewünschte Gruppe blinkt, drücken Sie , um ihre Auswahl zu bestätigen.

6.3 Einstellen einer vom Anwender definierten Puffergruppe

Wenn unter Schritt 6.2 der leere Rahmen blinkt, dann drücken sie die  Taste, um die Einstellung zu beginnen. Das Gerät zeigt den aktuell eingestellten Temperaturwert an, und der Punkt und Rahmen blinken (Grundeinstellung 25 °C). Benützen Sie die Tasten  oder , um den Wert zu verändern. Drücken sie die Taste  um den Wert abzuspeichern und fortzufahren.

Nachdem Sie den Temperaturwert eingegeben haben, zeigt das Gerät die aktuelle Einstellung des ersten Kalibrierungspuffers an (Grundeinstellung 4.00). Verwenden Sie die Tasten  oder , um den Wert zu verändern. Drücken sie die Taste , um den Wert abzuspeichern und fortzufahren.

Nachdem Sie den ersten Kalibrierungspuffer eingestellt haben, drücken Sie , um den nächsten Punkt einzustellen.

Das Verfahren ist dasselbe wie für den ersten Punkt. Sie können bis zu drei Anwender-definierte Kalibrierungspuffer einrichten. Wenn Sie Ihre Einstellungen vorgenommen haben, drücken Sie die Taste , um das Menü zu verlassen.

Hinweis

Wenn Sie eine vom Anwender definierte Puffergruppe für die Kalibrierung verwenden, erscheint der von Ihnen eingegebene Pufferwert. Vergewissern Sie sich, dass Sie den richtigen Puffer verwenden. Die Puffertemperatur sollte den eingegebenen Wert einhalten. Wird eine Temperatursonde eingesetzt und die gemessene Temperatur unterscheidet sich um mehr als 1 °C vom eingegebenen Wert, so erscheint Err 5 auf der Anzeige.

6.4 Kalibrierung

6.4.1 Einpunkt-Kalibrierung

Stellen Sie die Elektrode in einen Kalibrierungspuffer und drücken Sie .

Ihr SevenEasy pH-Meter erkennt bei der Kalibrierung den Endpunkt automatisch. Um den Endpunkt manuell zu bestimmen, drücken Sie . Das Gerät zeigt den relevanten Pufferwert an. Der Offset-Wert der Elektrode wird angezeigt.

Um zur Probenmessung zurückzukehren, drücken Sie .

6.4.2 Zweipunkt-Kalibrierung

1. Schritt Führen Sie eine "Einpunkt-Kalibrierung" wie oben beschrieben durch.
2. Schritt Spülen Sie die Elektrode mit destilliertem Wasser.
3. Schritt Stellen Sie die Elektrode in den nächsten Puffer und drücken Sie .

Ihr SevenEasy pH-Meter erkennt bei der Kalibrierung den Endpunkt automatisch. Um den Endpunkt manuell zu bestimmen, drücken Sie . Das Gerät zeigt den relevanten Pufferwert an. Der Offset-Wert der Elektrode wird aktualisiert und die Steigung wird angezeigt.

Um zur Probenmessung zurückzukehren, drücken Sie .

6.4.3 Dreipunkt-Kalibrierung

Führen Sie eine "Zweipunkt-Kalibrierung" gemäss obigem Beschrieb durch. Wiederholen Sie die Schritte 2 und 3 für die Dreipunkt-Kalibrierung.

Hinweis

Die Verwendung einer Temperatursonde oder einer Elektrode mit integrierter Temperatursonde wird empfohlen. Wenn Sie den MTC-Modus benützen, sollten alle Puffer und Probelösungen bei der gleichen, eingestellten Temperatur gehalten werden.

Um eine möglichst genaue pH-Messung zu erhalten, sollten Sie das Gerät regelmässig kalibrieren.











Um die Anzahl und Art der Puffer anzuzeigen, die für die Kalibrierung verwendet wurden, drücken und halten Sie die  Taste. Die Puffer-Werte werden abwechselnd angezeigt.

7. Selbsttest

Drücken und halten Sie die beiden Tasten  und  gleichzeitig bis das Symbol für den Selbsttest  erscheint.

Auf dem Gerät erscheinen zuerst alle Anzeigeelemente. Dann blinken die einzelnen Symbol nacheinander. Danach müssen die Tasten durch den Anwender geprüft werden.

Wenn das  Symbol blinkt, drücken Sie die entsprechende Taste innerhalb 5 Sekunden gemäss der nachfolgenden Liste:



- Wenn  blinkt, drücken Sie die Taste .
- Wenn  blinkt, drücken Sie die Taste .
- Wenn  blinkt, drücken Sie die Taste .
- Wenn  blinkt, drücken Sie die Taste .
- Wenn  blinkt, drücken Sie die Taste .

Ist der Selbsttest abgeschlossen, erscheint ein Häkchen ✓ in der Anzeige. Schlägt der Selbsttest fehl, sehen Sie unter "9. Fehlermeldungen" nach und leiten die notwendigen Massnahmen ein.

8. Alternativer Batteriebetrieb

Das SevenEasy pH-Meter kann auch mit Batterien betrieben werden. Setzen Sie 4 AA (LR6) Batterien auf der Unterseite des Geräts ein. Wird das Netzadapterkabel am Gerät ausgezogen, wechselt das pH-Meter automatisch auf Batteriebetrieb und das Symbol  erscheint.

Wenn die Batterien leer sind, erscheint das Symbol  für die Batterie in der Anzeige.

Im Batteriebetrieb verfügt das Gerät über eine automatische Ausschaltfunktion. Wird während 10 Minuten keine Taste gedrückt, so schaltet das Gerät automatisch aus, um die Batterie zu schonen. Um diese automatische Ausschaltfunktion zu umgehen, drücken und halten Sie die  Taste während 2 Sekunden, bis das Symbol  erscheint.

9. Fehlermeldungen

Error 1 - Offset liegt ausserhalb des erlaubten Bereiches

Vergewissern Sie sich, dass Sie den richtigen Puffer verwenden und dass er frisch ist. Elektrode reinigen oder austauschen.

Error 2 - Steigung liegt ausserhalb des erlaubten Bereiches

Vergewissern Sie sich, dass Sie den richtigen Puffer verwenden und dass er frisch ist. Elektrode reinigen oder austauschen.

Error 3 - Instrument erkennt den Puffer nicht

Vergewissern Sie sich, dass Sie den richtigen Puffer verwenden und dass er frisch ist. Überprüfen Sie, ob der Puffer bei der Kalibrierung mehrfach verwendet wurde.

Error 4 - Eingabefehler des anwenderdefinierten Pufferwertes

Wenn Sie die anwenderdefinierten Pufferwerte eingeben, akzeptiert das Instrument keine pH-Werte, welche weniger als 1 pH-Einheit von anderen definierten Werten entfernt sind. Geben Sie einen neuen Wert ein.

Error 5 - ATC Temperatur weicht vom anwenderdefinierten Wert ab.

Die Temperatur des Puffers oder der Probe sollte der eingegebenen Temperatur entsprechen. Wenn nötig, ändern Sie die Temperatureinstellung.

Error 6 - Gemessene Puffertemperatur liegt ausserhalb des erlaubten Bereiches (5... 50°C)

Die Temperatur des Puffers muss innerhalb der Bandbreite gehalten werden.

Error 7, (----) - mV Wert liegt ausserhalb des Messbereiches

Vergewissern Sie sich, dass die Elektrode angeschlossen ist.

Ist die Elektrode nicht angeschlossen, setzen Sie bitte die Kurzschlussklammer ein.

Error 8 - pH Wert liegt ausserhalb des Messbereiches

Überprüfen Sie, ob der Deckel der Elektrode entfernt wurde und ob die Elektrode richtig angeschlossen und in die Probe eingetaucht wurde.

Error 9 - Selbsttest fehlgeschlagen

Wiederholen Sie den Selbsttest und vergewissern Sie sich, dass Sie die richtigen Tasten gedrückt haben, wenn das  Symbol blinkt. Erscheint Err 9 immer noch, so kontaktieren Sie den METTLER TOLEDO Service.

10. Wartung

10.1 Wartung des Gerätes

Bei diesem Gerät und dem Netzadapter gibt es keine vom Anwender zu ersetzende Teile. Bitte öffnen Sie die Gehäuse nicht.

Das SevenEasy benötigt ausser einer gelegentlichen Reinigung mit einem feuchten Lappen keinen Unterhalt. Das Gehäuse besteht aus ABS/PC, das von einigen organischen Lösungen wie Toluol, Xylol und Methylethylketon angegriffen werden kann. Gutes Laborverhalten erfordert sofortiges Wegwischen ausgeleerter Flüssigkeiten.

10.2 Wartung der Elektrode

Vergewissern Sie sich, dass die Elektrode immer mit der angemessenen Lösung gefüllt ist. Für eine maximale Messgenauigkeit sollte jede eingefüllte Lösung, die nach aussen "gekrochen" und die Elektrode verkrustet haben könnte, mit destilliertem Wasser entfernt werden.

Lagern Sie die Elektrode immer richtig und lassen Sie sie nicht austrocknen.

Fällt der Steigungswert der Elektrode schnell ab, wird die Reaktionszeit träge oder werden die Messungen ungenau, können folgende Verfahren helfen. Wenden Sie sie in der nachstehenden Reihenfolge an.

1. Entfetten Sie die Membran mit in Aceton- oder Seifenlösung getauchter Watte.
2. Tauchen Sie die Elektrode über Nacht in 0.1 M HCl.
3. Entfernen Sie Proteinrückstände indem Sie die Elektrode in eine HCl/Pepsin-Lösung einlegen (Best.-Nr: 51340068).
4. Im Falle einer Silbersulfidkontamination, tauchen Sie die Elektrode in eine Thioharnstofflösung (Best.-Nr: 51340070).

Hinweis

Reinigungs- und Fülllösungen sollten mit der gleichen Vorsicht gehandhabt werden wie giftige oder ätzende Substanzen.

10.3 Entsorgung



In Übereinstimmung mit den Anforderungen der Europäischen Richtlinie 2002/96 EG über Elektro- und Elektronik-Altgeräte (WEEE) darf dieses Gerät nicht mit dem Hausmüll entsorgt werden. Sinngemäss gilt dies auch für Länder ausserhalb der EU entsprechend den geltenden nationalen Regelungen.

Bitte entsorgen Sie dieses Produkt gemäss den örtlichen Bestimmungen in einer getrennten Sammlung für Elektro- und Elektronikgeräte.

Bei allfälligen Fragen wenden Sie sich bitte an die zuständige Behörde oder den Händler, bei dem Sie dieses Gerät erworben haben.

Bei Weitergabe dieses Gerätes (z.B. für private oder gewerbliche/industrielle Weiternutzung) ist diese Bestimmung sinngemäss weiterzugeben.

Vielen Dank für Ihren Beitrag zum Schutz der Umwelt.

11. Zubehör

	Best.-Nr
Elektrodenarm komplett	51302820
Anleitung zur pH-Bestimmung	51300058
Anleitung zur Leiffähigkeits- und Sauerstoffmessung	51724715
Anleitung zur ionenselektiven Messung	51300201
pH 4,01 Puffer, 30 Beutel zu 20mL	51302069
pH 4,01 Puffer, 6 Flaschen zu 250mL	51340058
pH 7,00 Puffer, 30 Beutel zu 20mL	51302047
pH 7,00 Puffer, 6 Flaschen zu 250mL	51340060
pH 9,21 Puffer, 30 Beutel zu 20mL	51302070
pH 9,21 Puffer, 6 Flaschen zu 250mL	51300194
pH 10,01 Puffer, 30 Beutel zu 20mL	51302079
pH 10,01 Puffer, 6 Flaschen zu 250mL	51340231
InLab®410, pH-Elektrode, Temp.-Fühler, nachfüllbar	52000118
InLab®412, Labor pH-Elektrode, Glas, nachfüllbar	52000112
InLab®413, robuste pH-Elektrode, PEEK-Schaft, ATC	52000100
InLab®420, pH-Elektrode mit PTFE-Schliffdiaphragma	52000113
HCl/Pepsin-Lösung (entfernt Proteinverschmutzungen)	51340068
Thioharnstofflösung (entfernt Silbersulfidverschmutzungen)	51340070
Reaktivierungslösung für pH-Elektroden	51340073

12. Technische Daten

	pH	mV	Temperatur			
Messbereich	0,00 -14,00	± 1999	-5 ... 105 °C			
Auflösung	0,01	1	0,1 °C			
Relative Genauigkeit	± 0,01	± 1	± 0,5 °C			
pH-Kalibrierung	1, 2, oder 3 Punkte					
Isopotentialpunkt	7,00 pH					
Kalibrierungspuffer	B1: (25 °C)	7,00	4,00	10,01	1,68	
	B2: (25 °C)	7,00	4,01	9,21	2,00	11,00
	B3: (20 °C)	7,00	4,00	9,00	2,00	12,00
	B4: (25 °C)	6,86	4,01	9,18	1,68	
	B5: vom Anwender definiert					
Temperaturkompensation	-5 ... 105 °C automatisch oder manuell					
Anzeige	Flüssigkristallanzeige					
Ausgänge	RS232 seriell, Baudrate: 1200 Databit: 8 Stoppbit: 1 Parität: keine					
pH-Eingang	Impedanz > 10 ¹² Ohm					
Umgebungsbedingungen	Raumtemperatur:	5°C ... 40 °C				
	Relative Luftfeuchtigkeit:	5 % ... 80 %, (nicht kondensierend)				
	Überspannungskategorie:	II				
	Verschmutzungsgrad:	2				
Abmessung/Gewicht	180 x 180 x 65 (mm) / 0,61 kg					
Materialien	Gehäuse:	ABS, PC verstärkt				
	Elektrodenhalter:	ABS, PC verstärkt				
	Tastaturfolie:	Polyester				
Stromversorgung	Das SevenEasy pH-Meter ist mit einem Ihrer Region entsprechenden Netzadapter ausgerüstet:					
	- USA:	120 V / 60 Hz, 10 VA, 9 V DC				
	- Europa:	230 V / 50 Hz, 10 VA, 9 V DC				
	- GB:	240 V / 50 Hz, 10 VA, 9 V DC				
	- Japan:	110 V / 50 Hz, 10 VA, 9 V DC				
	- Australien:	240 V / 50 Hz, 10 VA, 9 V DC				
	- China:	220 V / 50 Hz, 10 VA, 9 V DC				
	- Batterie (fakultativ):	4 x AA (LR6)				

Hinweis

Das SevenEasy pH-Meter sollte nur mit dem gelieferten Netzadapter oder mit Batterien betrieben werden.

13. Quick Guide

1. Elektrode vorbereiten



Wässerungskappe entfernen

2. Einpunkt-Kalibrierung



pH Puffer 7
Rühren, dann belassen

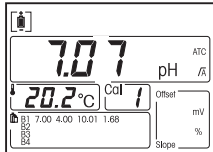

7.07 pH ATC
20.2°C Cal 1 Offset mV %
B1 7.00 4.00 10.01 1.68 Slope

automatischer Endpunkt oder

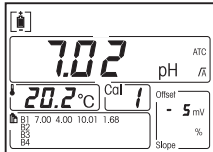

7.02 pH ATC
20.2°C Cal 1 Offset -5 mV %
B1 7.00 4.00 10.01 1.68 Slope

3. Elektrode spülen

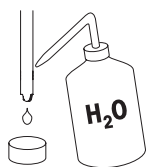

4. Zwei- oder Dreipunkt-Kalibrierung

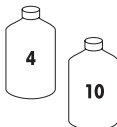

Wiederholen Sie Schritt 2 bei einer Zwei- oder Dreipunkt-Kalibrierung, dann spülen

5. Probe messen



Probe
Rühren, dann belassen

automatische Endpunkt oder

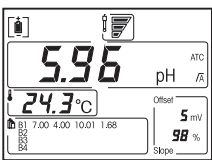

5.96 pH ATC
24.3°C Offset 5 mV %
B1 7.00 4.00 10.01 1.68 Slope 98

6. Elektrode spülen

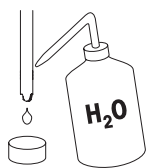

7. Elektrode lagern



Elektrolyt

14. Puffergruppen

Das SevenEasy pH-Meter kompensiert die eingestellte Temperatur automatisch gemäss den Werten in den Tabellen:

Puffergruppe 1 (ref. 25 °C) MT USA

5	7,09	4,00	10,25	1,67
10	7,06	4,00	10,18	1,67
15	7,04	4,00	10,12	1,67
20	7,02	4,00	10,06	1,68
25	7,00	4,00	10,01	1,68
30	6,99	4,01	9,97	1,68
35	6,98	4,02	9,93	1,69
40	6,97	4,03	9,89	1,69
45	6,97	4,04	9,86	1,70
50	6,97	4,06	9,83	1,71

Puffergruppe 2 (ref. 25 °C) MT Europa

5	7,09	4,01	9,45	2,02	11,72
10	7,06	4,00	9,38	2,01	11,54
15	7,04	4,00	9,32	2,00	11,36
20	7,02	4,00	9,26	2,00	11,18
25	7,00	4,01	9,21	2,00	11,00
30	6,99	4,01	9,16	1,99	10,82
35	6,98	4,02	9,11	1,99	10,64
40	6,97	4,03	9,06	1,98	10,46
45	6,97	4,04	9,03	1,98	10,28
50	6,97	4,06	8,99	1,98	10,10

Puffergruppe 3 (ref. 20 °C) Merck

5	7,07	4,04	9,16	2,01	12,41
10	7,05	4,02	9,11	2,01	12,26
15	7,02	4,01	9,05	2,00	12,10
20	7,00	4,00	9,00	2,00	12,00
25	6,98	4,01	8,95	2,00	11,88
30	6,98	4,01	8,91	2,00	11,72
35	6,96	4,01	8,88	2,00	11,67
40	6,95	4,01	8,85	2,00	11,54
45	6,95	4,01	8,82	2,00	11,44
50	6,95	4,00	8,79	2,00	11,33

Puffergruppe 4 (ref. 25 °C) Japan JIS

5	6,95	4,00	9,40	1,67
10	6,92	4,00	9,33	1,67
15	6,90	4,00	9,28	1,67
20	6,88	4,00	9,22	1,68
25	6,86	4,01	9,18	1,68
30	6,85	4,02	9,14	1,68
35	6,84	4,02	9,10	1,69
40	6,84	4,04	9,07	1,69
45	6,83	4,05	9,04	1,70
50	6,83	4,06	9,01	1,71

Sommaire

1.	Introduction	3
2.	Consignes de sécurité	3
	Pour votre propre sécurité	3
	Pour la sécurité de fonctionnement	3
3.	Description de l'appareil	4
	3.1 Affichage	4
	3.2 Clavier	5
4.	Installation	6
5.	Mesure d'un échantillon	8
	5.1 Mesure du pH	8
	5.2 Mesure en mV	8
	5.3 Réglages	8
	5.3.1 ATC	8
	5.3.2 MTC	8
	5.3.3 Sortie de données	8
6.	Etalonnage	9
	6.1 Réglages	9
	6.2 Sélection d'un ensemble de solutions tampon prédéfini	9
	6.3 Réglage d'un ensemble de tampons défini par l'utilisateur	9
	6.4 Etalonnage	10
	6.4.1 Etalonnage à 1 point	10
	6.4.2 Etalonnage à 2 points	10
	6.4.3 Etalonnage à 3 points	10
7.	Test d'autocontrôle	11
8.	Fonctionnement facultatif sur pile	11
9.	Messages d'erreur	12
10.	Entretien	13
	10.1 Entretien de l'appareil	13
	10.2 Entretien de l'électrode	13
	10.3 Elimination	13
11.	Accessoires	14
12.	Caractéristiques techniques	15
13.	Guide rapide	16
14.	Ensembles de solutions tampon d'étalonnage	17

1. Introduction

SevenEasy – un appareil qui répond à vos exigences bien au-delà de la simple mesure du pH et sans pour autant obérer votre budget. Un appareil aux nombreux avantages:

- L'interface utilisateur est conçue de manière à ce que toutes les opérations de commande s'expliquent d'elles-mêmes. Vous gagnez ainsi beaucoup de temps.
- Grâce à l'alimentation piles, l'appareil peut être rapidement installé et utilisé sur une autre table du laboratoire, voire même dans un autre laboratoire, et aussi à des endroits où un raccordement au secteur n'est pas possible.
- Les prestations de service permettent la qualification périodique de vos appareils et augmentent la disponibilité et l'exactitude de votre appareil.

2. Consignes de sécurité

Pour votre propre sécurité



- Travailler en atmosphère non explosible! Le boîtier de l'appareil n'est pas étanche aux gaz. La pénétration de gaz pourrait créer un danger de corrosion et/ou d'explosion en cas d'étincelles.



- Respecter les instructions du fabricant pour les produits chimiques et solvants employés, ainsi que les règles de sécurité courantes du laboratoire!

Pour la sécurité de fonctionnement



- Confier la maintenance de l'appareil exclusivement à METTLER TOLEDO!
- Essuyer régulièrement les projections de liquides! L'appareil n'est pas étanche à l'eau.
- N'utiliser que des piles du modèle spécifié. Sinon le parfait fonctionnement ne serait pas garanti.
- Éviter les facteurs ambiants suivants:
 - fortes vibrations,
 - exposition directe au soleil,
 - humidité relative de l'air supérieure à 80%,
 - atmosphère de gaz corrosifs,
 - température inférieure à 5 °C et supérieure à 40 °C,
 - champs électriques ou magnétiques puissants!

3. Description de l'appareil

3.1 Affichage

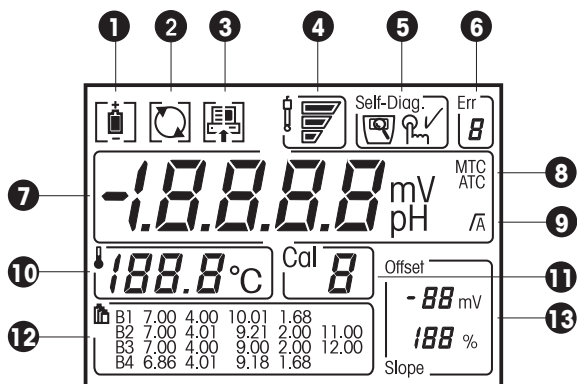

1 Etat de la pile

2 Désactivation de l'arrêt automatique pendant le fonctionnement piles

3 Transfert des données vers PC/imprimante

4 Etat de l'électrode



pende: 95 - 105 %
zéro: \pm (0-15) mV
électrode en bon état



pende: 90 - 94 %
zéro: \pm (15 - 35) mV
l'électrode a besoin d'un nettoyage



pende: 85 - 89 %
zéro: \pm (>35) mV
l'électrode est défectueuse

5 Test d'autocontrôle de l'appareil



affichage du test d'autocontrôle



injonction de presser des touches



test d'autocontrôle réussi

6 Numéro de l'erreur

7 Mesure pH/mV

8 Compensation de température automatique/manuelle

9 Stabilité du point final/point final automatique



Stabilité du point final



Point final automatique

10 Température









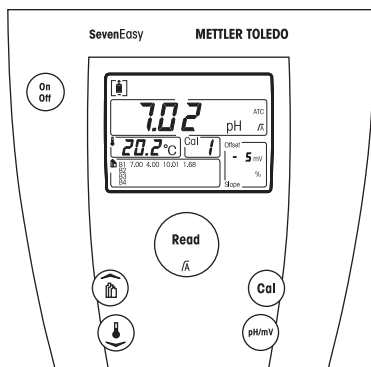



11 Point d'étalonnage

12 Ensembles de solutions tampon d'étalonnage

13 Valeur de décalage et pente de l'électrode

3.2 Clavier



	presser et relâcher 	presser pendant 2 secondes 	
	appareil marche/arrêt	désactivation de l'arrêt automatique pendant le fonctionnement piles	
	<ul style="list-style-type: none"> - mesure du point de départ ou point final - retour au mode mesure - enregistrer la valeur entrée 	point final automatique marche/arrêt	
	<ul style="list-style-type: none"> - commencer l'étalonnage - confirmer le groupe de tampons sélectionné 	Indication des tampons utilisés pour la calibration	
	commuter entre les modes de mesure transfert des données pH et mV	transfert des données vers le PC ou l'imprimante	
	<ul style="list-style-type: none"> - séquence des solutions tampon d'étalonnage - augmenter la valeur pendant le réglage 		
	<ul style="list-style-type: none"> - régler la température MTC, - diminuer la valeur pendant le réglage 		
	commencer le test d'autocontrôle Self-Diag.		

4. Installation

1. Déballer l'appareil, l'adaptateur secteur, l'électrode, le bras porte-électrode et les autres accessoires. Conserver le certificat d'étalonnage en un endroit sûr.
2. S'assurer que l'adaptateur secteur correspond à la tension secteur locale. Sinon, contactez votre représentant METTLER TOLEDO.
3. Installer le bras porte-électrode.

- Le porte-électrode peut être employé seul ou être monté sur l'appareil. Il est placé sur le socle dans une des trois positions prévues. Si le porte-électrode doit être employé seul, il est recommandé d'utiliser le trou médian. D'abord enlever le cache. Fixer le support à l'aide de la vis fournie. Si le porte-électrode doit être employé seul, l'installation est alors terminée.

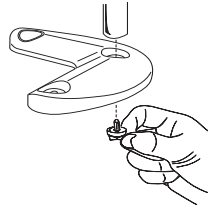

- Si le porte-électrode doit être monté sur l'appareil, placer l'appareil sur le socle de manière à ce que l'aile libre du socle regarde vers l'arrière. D'abord enlever le cache. Le porte-électrode peut être fixé sur la gauche ou la droite de l'appareil.

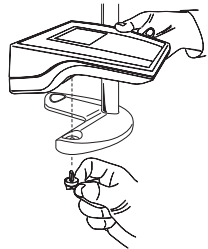

- Tourner le bouton de serrage en fonction des besoins.

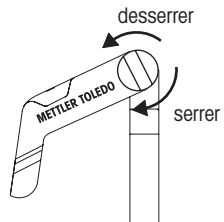

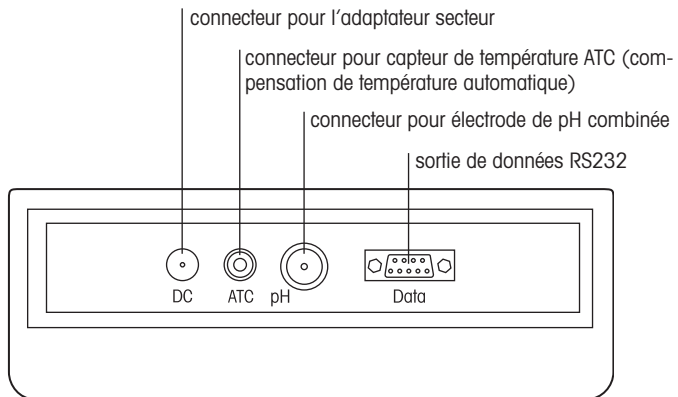

4. Enlever la pince de court-circuitage du connecteur pH.
5. Raccorder l'électrode. En cas d'utilisation d'une électrode avec capteur de température intégré, relier l'autre câble au connecteur ATC.
6. En cas d'utilisation d'un capteur de température séparé, le relier au connecteur ATC.
7. Relier l'adaptateur secteur au connecteur de courant continu (DC).



5. Mesure d'un échantillon

5.1 Mesure du pH

Plonger l'électrode dans l'échantillon et presser  pour commencer la mesure – le point décimal clignote.

L'afficheur indique le pH de l'échantillon et le réglage de base de l'appareil est point final automatique **A**. Lorsque les indications du capteur se sont stabilisées, l'afficheur se fige automatiquement et affiche \sqrt{A} .

Pour ce point final automatique, la valeur doit changer moins de 0,1 mV pendant 5 seconds.

On peut passer du format point final automatique à manuel et inversement en maintenant la pression sur la touche . Pour entrer manuellement le format point final d'une mesure, presser la touche . L'afficheur se fige et affiche \sqrt{A} .

5.2 Mesure en mV

Pour mesurer en mV, procéder comme pour une mesure du pH. Pour voir la valeur mV, il faut presser la touche .





5.3 Réglages

5.3.1 ATC

En vue d'une meilleure exactitude nous recommandons l'utilisation d'un capteur de température intégré ou séparé. Lorsqu'un capteur de température est utilisé, le symbole **ATC** et la température de l'échantillon sont affichés.



5.3.2 MTC

Quand l'appareil constate l'absence d'un capteur de température, il passe automatiquement en mode manuel de compensation de la température et affiche **MTC**.

Pour régler la température MTC, presser . Les touches  et  servent à augmenter ou diminuer la valeur de la température. Confirmer l'entrée en pressant la touche . Le réglage de base est 25 °C.

5.3.3 Sortie de données

En cas de raccordement d'un PC ou d'une imprimante, chaque mesure à point final est transmise au PC ou à l'imprimante à travers le connecteur RS232.

En maintenant la pression sur la touche , l'afficheur indique . L'appareil transmet une mesure par seconde jusqu'à ce que le point final soit atteint.

6. Etalonnage

6.1 Réglages

Le pH-mètre SevenEasy permet des étalonnages à 1, 2 et 3 points. En sélectionnant votre ensemble de solutions tampon d'étalonnage parmi les quatre groupes prédéfinis dans l'appareil, la reconnaissance automatique du groupe se fait en cours d'étalonnage.



Les 4 ensembles de solutions tampons d'étalonnage prédéfinis sont:

B1: (25 °C)	7,00	4,00	10,01	1,68	
B2: (25 °C)	7,00	4,01	9,21	2,00	11,00
B3: (20 °C)	7,00	4,00	9,00	2,00	12,00
B4: (25 °C)	6,86	4,01	9,18	1,68	





Vous pouvez définir votre propre groupe de tampons grâce aux réglages décrits ci-après. Pendant l'étalonnage, la reconnaissance automatique des tampons est inactive.



6.2 Sélection d'un ensemble de solutions tampon prédéfini

Presser la touche  et l'ensemble actuel clignote. Si l'ensemble actuel est un ensemble défini par l'utilisateur, le cadre vide clignote.

Utiliser les touches  ou , pour sélectionner un autre ensemble en position supérieure ou inférieure. Lorsque l'ensemble voulu clignote, presser  pour confirmer la sélection.

6.3 Réglage d'un ensemble de tampons défini par l'utilisateur

A l'étape 6.2, lorsque le cadre vide clignote, presser la touche  pour commencer le réglage. L'appareil indique la valeur actuelle de réglage de la température, et le point et le cadre clignotent (réglage de base 25 °C). Utiliser les touches  ou  pour modifier la valeur. Presser la touche  pour enregistrer la valeur et poursuivre.

Après entrée de la température, l'appareil indique le réglage actuel du premier tampon d'étalonnage (réglage de base 4.00). Utiliser les touches  ou  pour modifier la valeur. Presser la touche  pour enregistrer la valeur et poursuivre.

Après avoir réglé le premier tampon d'étalonnage, presser  pour passer à l'étape suivante.

Le procédé est le même que pour la première étape. Vous pouvez installer jusqu'à trois tampons d'étalonnage définis par l'utilisateur. Lorsque les réglages sont terminés, presser la touche  pour quitter le menu.

Remarque

Si vous utilisez, pour l'étalonnage, un ensemble de tampons défini par l'utilisateur, l'appareil indique la valeur tampon que vous avez entrée. Vérifiez que vous utilisez bien le bon tampon. La température du tampon doit correspondre à la valeur entrée. Lorsqu'un capteur de température est employé et que la température mesurée s'écarte de plus de 1 °C de la valeur entrée, l'appareil affiche Err 5.

6.4 Etalonnage

6.4.1 Etalonnage à 1 point

Plonger l'électrode dans une solution tampon d'étalonnage et presser .

Le pH-mètre SevenEasy atteint automatiquement le point final. Pour atteindre le point final manuellement, presser . L'appareil indique la valeur tampon et la maintient. Il affiche la valeur du zéro de l'électrode.

Pour revenir à la mesure d'échantillons, presser .

6.4.2 Etalonnage à 2 points

Etape 1 Effectuer un "étalonnage à 1 point" comme décrit ci-dessus.

Etape 2 Rincer l'électrode avec de l'eau distillée.

Etape 3 Plonger l'électrode dans le tampon suivant et presser .

Le pH-mètre SevenEasy atteint automatiquement le point final. Pour atteindre le point final manuellement, presser . L'appareil indique la valeur tampon et la maintient. Il actualise la valeur du zéro de l'électrode et affiche la pente.

Pour revenir à la mesure d'échantillons, presser .

6.4.3 Etalonnage à 3 points



Effectuer un "étalonnage à 2 points" comme décrit ci-dessus. Répéter les étapes 2 et 3 pour l'étalonnage à 3 points.

Remarque

Il est recommandé d'utiliser un capteur de température ou une électrode avec capteur de température intégré. Si vous travaillez en mode MTC, tous les tampons et solutions échantillons devraient être maintenus à la même température.











Pour obtenir une mesure du pH aussi exacte que possible, l'appareil doit être étalonné régulièrement. Pour afficher le nombre et le type de tampon utilisés pour la calibration, presser la touche  plus de 2 secondes. Les tampons apparaîtront tour à tour.

7. Test d'autocontrôle

Presser simultanément et maintenir les deux touches  et  jusqu'à l'affichage du symbole d'autocontrôle .

L'afficheur présente d'abord tous les éléments d'affichage. Les différents symboles clignotent ensuite successivement. Finalement, il faut encore contrôler les touches, ce qui nécessite l'intervention de l'utilisateur.

Lorsque le symbole  clignote, presser la touche correspondante en l'espace de 5 secondes, conformément à la liste suivante:



- lorsque  clignote, presser la touche ;
- lorsque  clignote, presser la touche ;
- lorsque  clignote, presser la touche ;
- lorsque  clignote, presser la touche ;
- lorsque  clignote, presser la touche .

Lorsque le test d'autocontrôle est terminé, un crochet ✓ est affiché. Si le test d'autocontrôle échoue, consulter "9. Messages d'erreur" et prendre les mesures qui s'imposent.

8. Fonctionnement facultatif sur pile

Le pH-mètre SevenEasy peut également fonctionner sur pile. Insérer 4 piles AA (LR6) à la base de l'appareil. Lorsque le câble de l'adaptateur secteur est retiré de l'appareil, ce dernier fonctionne sur pile et le symbole  est affiché.

Si les piles sont déchargées, le symbole  est affiché.

En fonctionnement sur pile, l'appareil dispose d'une fonction d'arrêt automatique. Au bout de 10 minutes sans action sur une touche, l'appareil s'arrête automatiquement pour ménager la pile. Pour contourner cette fonction d'arrêt automatique, presser et maintenir la touche  pendant 2 secondes jusqu'à l'affichage du symbole .

9. Messages d'erreur

Error 1 - Le décalage tombe hors de la plage permise

S'assurer que vous utilisez le bon tampon et qu'il est frais. Nettoyer ou remplacer l'électrode.

Error 2 - La pente tombe hors de la plage permise

S'assurer que vous utilisez le bon tampon et qu'il est frais. Nettoyer ou remplacer l'électrode.

Error 3 - L'instrument ne reconnaît pas le tampon

S'assurer que vous utilisez le bon tampon et qu'il est frais. Vérifier que le même tampon n'a pas été utilisé deux fois pour l'étalonnage.

Error 4 - Erreur d'entrée de la valeur du tampon définie par l'utilisateur

Lors de l'entrée des valeurs tampons définies par l'utilisateur, l'appareil refuse les valeurs de pH qui diffèrent de moins d'une unité de pH par rapport aux autres valeurs définies. Entrer une nouvelle valeur.

Error 5 - La température ATC s'écarte de la valeur définie par l'utilisateur.

Le tampon ou l'échantillon devrait être à la température définie. Si nécessaire, changer le paramètre température.

Error 6 - La température mesurée du tampon tombe hors de la plage permise (5... 50°C)

Il faut maintenir la température du tampon à l'intérieur de la plage permise.

Error 7, La valeur (----) - mV tombe hors de la plage de mesure

S'assurer que l'électrode est bien raccordée.

Si l'électrode n'est pas raccordée, insérer la pince de court-circuitage.

Error 8 - Le pH tombe hors de la plage de mesure

Vérifier que le capuchon de l'électrode a été enlevé et que l'électrode est bien raccordée et plonge effectivement dans l'échantillon.

Error 9 - Echec du test d'autocontrôle

Répéter le test d'autocontrôle et s'assurer que vous avez bien pressé les bonnes touches lorsque le symbole  clignote. Si Err 9 se répète, contacter le service après-vente METTLER TOLEDO.

10. Entretien

10.1 Entretien de l'appareil

Cet appareil et l'adaptateur secteur ne comportent pas de pièces pouvant être remplacées par l'utilisateur. Prière de ne pas ouvrir le boîtier.

A part un nettoyage occasionnel à l'aide d'un chiffon humide, le SevenEasy ne requiert pas d'entretien. Le boîtier est en ABS/PC qui peut être attaqué par des solvants organiques tels le toluène, le xylène et la butanone. La bonne pratique du laboratoire veut que les liquides renversés soient immédiatement essuyés.

10.2 Entretien de l'électrode

S'assurer que l'électrode est toujours remplie de la bonne solution. Pour un maximum d'exactitude de mesure, il convient de laver à l'eau distillée toute trace de solution de remplissage pouvant avoir "grimpé" sur l'électrode et l'avoir encroûtée.

Toujours conserver correctement l'électrode et ne jamais la laisser se dessécher.

Les procédés suivant peuvent aider lorsque la valeur de la pente de l'électrode tombe rapidement, que le temps de réaction devient long ou que les mesures deviennent inexactes. Les utiliser dans l'ordre suivant.

1. Dégraisser la membrane avec de l'ouate trempée d'acétone ou de solution savonneuse.
2. Laisser tremper la pointe de l'électrode pendant la nuit dans 0.1 M HCl.
3. En cas de dépôt de protéines, l'enlever en faisant tremper l'électrode dans une solution de HCl/pepsine (référence pour la commande: 51340068).
4. En cas de contamination par du sulfure d'argent, tremper l'électrode dans une solution de thiourée (référence pour la commande: 51340070).

Remarque

Manipuler les solutions de nettoyage et de remplissage avec les mêmes précautions que celles prises pour les substances toxiques ou corrosives.

10.3 Elimination



En conformité avec les exigences de la directive européenne 2002/96 CE relative aux déchets d'équipements électriques et électroniques (DEEE), cet appareil ne doit pas être éliminé avec les déchets ménagers. Logiquement, ceci est aussi valable pour les pays en dehors de l'UE conformément aux réglementations nationales en vigueur.

■ Veuillez éliminer cet appareil conformément aux prescriptions locales dans un conteneur séparé pour appareils électriques et électroniques.

Pour toute question, adressez-vous aux autorités compétentes ou au revendeur chez qui vous avez acheté cet appareil.

En cas de remise de cet appareil (p. ex. pour une utilisation privée ou artisanale/industrielle), cette prescription doit être transmise en substance.

Merci pour votre contribution à la protection de l'environnement.

11. Accessoires

	référence
Bras porte-électrode complet	51302820
Guide pour les mesures de pH	51300185
Guide de mesure de la conductivité et de l'oxygène dissous	51724717
Guide pour les mesures ionométriques	51300200
<hr/>	
Tampon pH 4,01, 30 sachets de 20mL	51302069
Tampon pH 4,01, 6 flacons de 250mL	51340058
Tampon pH 7,00, 30 sachets de 20mL	51302047
Tampon pH 7,00, 6 flacons de 250mL	51340060
Tampon pH 9,21, 30 sachets de 20mL	51302070
Tampon pH 9,21, 6 flacons de 250mL	51300194
Tampon pH 10,01, 30 sachets de 20mL	51302079
Tampon pH 10,01, 6 flacons de 250mL	51340231
<hr/>	
InLab®410, électrode de pH, capteur de température, remplissable	52000118
InLab®412, électrode de pH de laboratoire, verre, remplissable	52000112
InLab®413, électrode de pH robuste, tige en PEEK, ATC	52000100
InLab®420, électrode de pH avec diaphragme PTFE à rodage	52000113
<hr/>	
Solution de HCl/pepsine (enlève les dépôts de protéines)	51340068
Solution de thiourée (enlève les dépôts de sulfure d'argent)	51340070
Solution de réactivation pour électrodes de pH	51340073

12. Caractéristiques techniques

	pH	mV	température			
Plage de mesure	0,00 -14,00	± 1999	-5 ... 105 °C			
Résolution	0,01	1	0,1 °C			
Exactitude relative	± 0,01	± 1	± 0,5 °C			
Etalonnage pH	1, 2, ou 3 points					
Point isopotentiel	7,00 pH					
Tampons d'étalonnage	B1: (25 °C)	7,00	4,00	10,01	1,68	
	B2: (25 °C)	7,00	4,01	9,21	2,00	11,00
	B3: (20 °C)	7,00	4,00	9,00	2,00	12,00
	B4: (25 °C)	6,86	4,01	9,18	1,68	
	B5: défini par l'utilisateur					
Compensation de température	-5 ... 105 °C, automatique ou manuelle					
Affichage	à cristaux liquides					
Sorties	série RS232, vitesse de transmission: 1200 baud bits de données: 8 bit d'arrêt: 1 parité: néant					
Entrée pH	impédance > 10 ¹² Ohm					
Conditions ambiantes	température: 5 °C ... 40 °C humidité relative: 5 % ... 80 %, (non condensante) catégorie de surtension: II degré d'encrassement: 2					
Dimensions/poids	180 x 180 x 65 (mm) / 0,61 kg					
Matériaux	Boîtier: ABS, renforcé avec PC Porte-électrode: ABS, renforcé avec PC Feuille du clavier: Polyester					
Alimentation	le pH-mètre SevenEasy est équipé d'un adaptateur secteur pour votre région: - Etats-Unis: 120 V / 60 Hz, 10 VA, 9 V DC - Europe: 230 V / 50 Hz, 10 VA, 9 V DC - Royaume Uni: 240 V / 50 Hz, 10 VA, 9 V DC - Japon: 110 V / 50 Hz, 10 VA, 9 V DC - Australie: 240 V / 50 Hz, 10 VA, 9 V DC - Chine: 220 V / 50 Hz, 10 VA, 9 V DC - piles (facultatives): 4 x AA (LR6)					

Remarque

N'alimenter le pH-mètre SevenEasy qu'à l'aide de l'adaptateur secteur fourni avec l'appareil ou par des piles.

13. Guide rapide

1. Préparer l'électrode



enlever le capuchon humidificateur

2. Etalonnage à 1 point

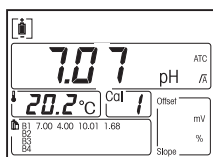
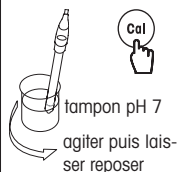

point final automatique ou

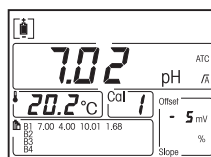

3. Rincer l'électrode

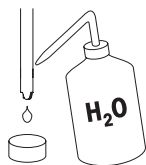

4. Etalonnage à 2 ou 3 points

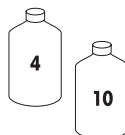

répéter l'étape 2 pour l'étalonnage à 2 ou 3 points, puis rincer

5. Mesurer l'échantillon



point final automatique ou

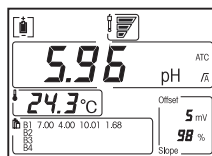

6. Rincer l'électrode

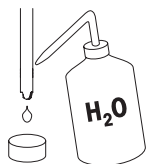

7. Conserver l'électrode



14. Ensembles de solutions tampon d' étalonnage

Le pH-mètre SevenEasy compense automatiquement la température réglée en fonction des valeurs figurant dans les tableaux:

Groupe de tampons 1 (réf. 25 °C) MT US

5	7,09	4,00	10,25	1,67
10	7,06	4,00	10,18	1,67
15	7,04	4,00	10,12	1,67
20	7,02	4,00	10,06	1,68
25	7,00	4,00	10,01	1,68
30	6,99	4,01	9,97	1,68
35	6,98	4,02	9,93	1,69
40	6,97	4,03	9,89	1,69
45	6,97	4,04	9,86	1,70
50	6,97	4,06	9,83	1,71

Groupe de tampons 2 (réf. 25 °C) MT Europe

5	7,09	4,01	9,45	2,02	11,72
10	7,06	4,00	9,38	2,01	11,54
15	7,04	4,00	9,32	2,00	11,36
20	7,02	4,00	9,26	2,00	11,18
25	7,00	4,01	9,21	2,00	11,00
30	6,99	4,01	9,16	1,99	10,82
35	6,98	4,02	9,11	1,99	10,64
40	6,97	4,03	9,06	1,98	10,46
45	6,97	4,04	9,03	1,98	10,28
50	6,97	4,06	8,99	1,98	10,10

Groupe de tampons 3 (réf. 20 °C) Merck étalon

5	7,07	4,04	9,16	2,01	12,41
10	7,05	4,02	9,11	2,01	12,26
15	7,02	4,01	9,05	2,00	12,10
20	7,00	4,00	9,00	2,00	12,00
25	6,98	4,01	8,95	2,00	11,88
30	6,98	4,01	8,91	2,00	11,72
35	6,96	4,01	8,88	2,00	11,67
40	6,95	4,01	8,85	2,00	11,54
45	6,95	4,01	8,82	2,00	11,44
50	6,95	4,00	8,79	2,00	11,33

Groupe de tampons 4 (ref. 25 °C) Japon JIS

5	6,95	4,00	9,40	1,67
10	6,92	4,00	9,33	1,67
15	6,90	4,00	9,28	1,67
20	6,88	4,00	9,22	1,68
25	6,86	4,01	9,18	1,68
30	6,85	4,02	9,14	1,68
35	6,84	4,02	9,10	1,69
40	6,84	4,04	9,07	1,69
45	6,83	4,05	9,04	1,70
50	6,83	4,06	9,01	1,71

Sumario

1.	Introducción	3
2.	Medidas de seguridad	3
	Medidas para su protección	3
	Medidas para la seguridad funcional	3
3.	Descripción del instrumento	4
	3.1 Indicador	4
	3.2 Teclado	5
4.	Instalación	6
5.	Medición de las muestras	8
	5.1 Medición de pH	8
	5.2 Medición de mV	8
	5.3 Ajustes	8
	5.3.1 ATC	8
	5.3.2 MTC	8
	5.3.3 Salida de datos	8
6.	Calibración	9
	6.1 Ajustes	9
	6.2 Selección de un grupo de tampones predefinidos	9
	6.3 Ajuste de un grupo de tampones definido por el usuario	9
	6.4 Calibración	10
	6.4.1 Calibración a 1 punto	10
	6.4.2 Calibración de 2 puntos	10
	6.4.3 Calibración de 3 puntos	10
7.	Test de autocontrol	11
8.	Operación con pilas opcional	11
9.	Mensajes de error	12
10.	Mantenimiento	13
	10.1 Mantenimiento del instrumento	13
	10.2 Mantenimiento del electrodo	13
	10.3 Eliminación de residuos	13
11.	Accesorios	14
12.	Características técnicas	15
13.	Quick Guide	16
14.	Grupo de tampones	17

1. Introducción

SevenEasy – un instrumento que satisface sus exigencias, mucho más allá de la simple medición del pH, con un costo reducido y numerosas ventajas:

- El entorno del usuario está ideado de forma que la ejecución de cada fase operativa se explica por sí sola, lo que le permite ahorrar mucho tiempo.
- Gracias a la alimentación por pilas, el instrumento se puede instalar y utilizar rápidamente en otra mesa de laboratorio, o incluso en un laboratorio distinto, así como en lugares donde no se pueda usar alimentación eléctrica.
- Las prestaciones de servicio permiten la cualificación periódica de su instrumento, aumentando así la disponibilidad y exactitud del mismo.

2. Medidas de seguridad

Medidas para su protección



- ¡No trabajar en entorno expuesto a explosiones! La carcasa del instrumento no es hermética a los gases y existe el peligro de explosión por formación de chispas y/o peligro de corrosión por los gases introducidos.



- ¡Si utiliza productos químicos y disolventes siga las normas del fabricante y las normas de seguridad generales del laboratorio!

Medidas para la seguridad funcional



- ¡Encargue el mantenimiento del instrumento sólo al servicio METTLER TOLEDO!
- ¡Seque las salpicaduras de líquidos! El instrumento no es hermético al agua.
- No utilice pilas que no sean del tipo especificado. En otro caso no se garantiza un funcionamiento correcto.
- Evite los efectos ambientales siguientes:
 - vibraciones fuertes,
 - radiación solar directa,
 - humedad del aire superior al 80%,
 - atmósfera de gas corrosivo,
 - temperaturas inferiores a 5 °C y superiores a 40 °C,
 - ¡campos eléctricos o magnéticos fuertes!

3. Descripción del instrumento

3.1 Indicador

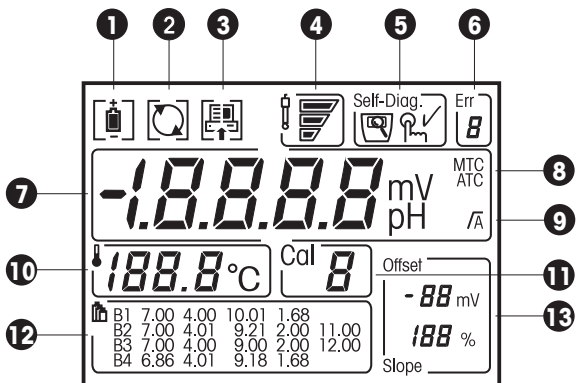

1 Estado de las pilas

2 Anulación de la desactivación automática durante la operación con pilas

3 Transferencia de datos a PC/impresora

4 Estado del electrodo



Pendiente: 95-105 %
Offset: \pm (0-15) mV
Buen estado del electrodo



Pendiente: 90-94 %
Offset: \pm (15-35) mV
El electrodo necesita limpieza



Pendiente: 85-89 %
Offset: \pm (>35) mV
Electrodo defectuoso

5 Autotest del instrumento



Autotest del indicador



Indicación de pulsar tecla



Autotest positivo

6 Número de error

7 Medición de pH/mV

8 Compensación de temperatura autom./manual

9 Estabilidad del punto final/punto final autom.



Estabilidad del punto final



Punto final autom.

10 Temperatura

11 Punto de calibración

12 Grupos de tampones





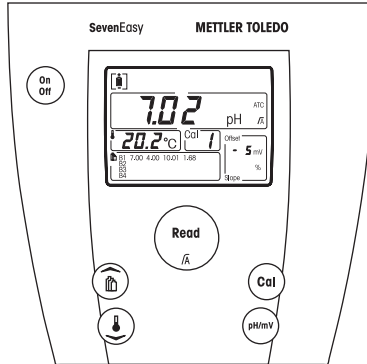





13 Offset y pendiente del electrodo

3.2 Teclado



Pulsar y soltar

Pulsar y mantener pulsada durante 2 s

	Medidor on/off	Anulación de la desactivación autom. en operación con pilas 
	<ul style="list-style-type: none"> - Medición de punto inicial o final - Retorno al modo medida - Almacenar valor introducido 	Activar/desactivar punto final autom. 
	<ul style="list-style-type: none"> - Comenzar calibración - Confirmar grupo de tampones seleccionados 	Visualización del tampón usado en la calibración.
	Alternar entre modo de medida pH y mV	Transmisión de datos al PC o impresora 
	<ul style="list-style-type: none"> - Selección de los grupos de tampones de calibración - Aumenta el valor durante el ajuste 	
	<ul style="list-style-type: none"> - Ajustar temperatura MTC - Reduce el valor durante el ajuste 	
	Iniciar el autotest 	

4. Instalación

1. Desembale el instrumento, el alimentador, el electrodo, el brazo portaelectrodo y los demás accesorios. Conserve el certificado de calibración en lugar seguro.
2. Asegurese de que el alimentador corresponde a su red eléctrica. En caso contrario, póngase en contacto con su distribuidor METTLER TOLEDO.
3. Instale el brazo portaelectrodo.

- Se puede usar el portaelectrodo suelto de pie, o montado en el instrumento. Se pone sobre el soporte en una de las tres posiciones. En caso de que se use suelto de pie, se recomienda utilizar el orificio central. Primero hay que retirar la tapa correspondiente. Afiance la unión mediante el tornillo de fijación entregado. La instalación termina aquí si el portaelectrodo se va a usar de pie suelto.

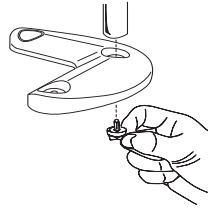

- Si se va a sujetar el portaelectrodo en el instrumento, ponga éste sobre el soporte, de modo que la aleta libre del soporte quede orientada hacia atrás. Primero hay que retirar la tapa correspondiente. El portaelectrodo se puede fijar en la parte izquierda o derecha del instrumento.

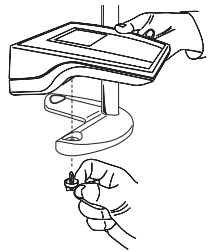

- Regule el botón giratorio de tensión según sea necesario.

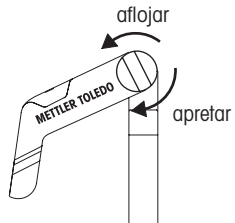

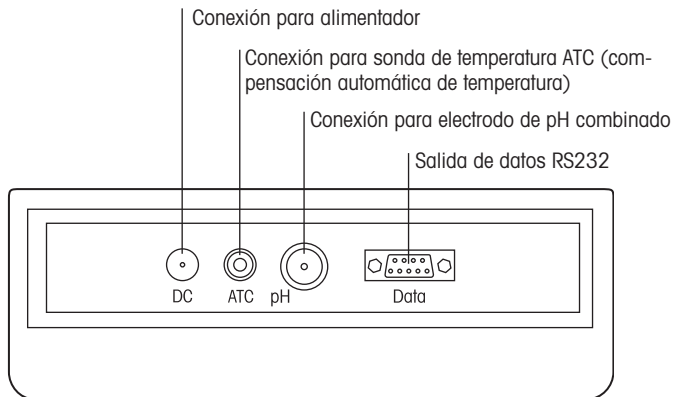

4. Retire la horquilla cortacircuito de la conexión pH.
5. Conecte el electrodo. Si utiliza un electrodo con sonda de temperatura integrada, conecte el otro cable a la conexión ATC.
6. Si utiliza una sonda de temperatura separada, conéctela a la conexión ATC.
7. Conecte la unidad de alimentación al conector de corriente continua (DC).



5. Medición de las muestras

5.1 Medición de pH

Ponga el electrodo en la muestra y pulse  para empezar la medición – el punto decimal parpadea.

El indicador presenta el valor de pH actual. El ajuste básico del instrumento es el punto final **A** (automático). Cuando la señal del sensor se han estabilizado, el indicador se para automáticamente y aparece \sqrt{A} .

El algoritmo del punto final automático es 0,1 mV por 5 segundos.

Manteniendo pulsada la tecla  puede Vd. cambiar entre formato de punto final automático o manual. Para introducir a mano el punto final para una medición, pulse la tecla . El indicador se detiene y aparece \sqrt{A} .

5.2 Medición de mV

Para efectuar una medición de mV, proceda del mismo modo que con una medición de pH. Pulsando la tecla  verá el valor en mV.

5.3 Ajustes

5.3.1 ATC

Para una mayor exactitud recomendamos usar una sonda de temperatura integrada o separada. Al utilizar una sonda de temperatura aparecen en el indicador el símbolo **ATC** y la temperatura de la muestra.

5.3.2 MTC

Cuando el instrumento detecta que no hay conectada sonda de temperatura, cambia automáticamente al modo de compensación de temperatura manual, y el indicador señala **MTC**.

Para ajustar el temperatura MTC, pulse . Utilice  y  para desplazar el valor de temperatura hacia abajo o hacia arriba. Confirme su entrada pulsando la tecla . El ajuste básico es 25 °C.

5.3.3 Salida de datos

Si hay conectado un PC o impresora, cualquier medición de punto final es transmitida al PC o impresora a través de la conexión RS232.

Manteniendo pulsada la tecla , aparece  en el indicador. El instrumento transmite una medición por segundo hasta llegar al punto final.

6. Calibración

6.1 Ajustes

El pH-metro SevenEasy permite calibraciones a 1, 2 y 3 puntos. Si Vd. selecciona su grupo de tampones de calibración entre los cuatro grupos predefinidos en el instrumento, durante la calibración se lleva a cabo la detección automática del grupo de tampones.



Los 4 grupos de tampones predefinidos son:

B1: (25 °C)	7,00	4,00	10,01	1,68		
B2: (25 °C)	7,00	4,01	9,21	2,00	11,00	
B3: (20 °C)	7,00	4,00	9,00	2,00	12,00	
B4: (25 °C)	6,86	4,01	9,18	1,68		





Con el ajuste de tampón abajo descrito, puede Vd. definir su propio grupo de tampones. Durante la calibración, la detección automática de tampón no está activada.

6.2 Selección de un grupo de tampones predefinidos

Pulse la tecla  y el grupo de tampones actuales empezará a parpadear. Si el grupo actual está definido por el usuario, el cuadro vacío parpadea.

Utilice la tecla  o la  para seleccionar otros grupos en la posición superior o inferior. Cuando parpadee el grupo deseado, pulse  para confirmar su selección.

6.3 Ajuste de un grupo de tampones definido por el usuario

Si en el paso 6.2 parpadea el cuadro vacío, pulse la tecla  para empezar el ajuste. El instrumento señala el valor de temperatura ajustado en ese momento, y el punto y el cuadro parpadean (ajuste básico 25 °C). Utilice la tecla  o la  para cambiar el valor. Pulse la tecla  para almacenar el valor y continuar.

Después de introducir el valor de temperatura, el instrumento muestra el ajuste actual del primer tampón de calibración (ajuste básico 4.00). Utilice la tecla  ó  para cambiar el valor. Pulse la tecla  para guardar el valor y continuar.

Después de ajustar el primer tampón de calibración, pulse la tecla  para ajustar el punto siguiente.

El procedimiento es el mismo que para el primer punto. Puede introducir hasta tres tampones de calibración definidos por el usuario. Cuando haya efectuado sus ajustes, pulse la tecla  para salir del menú.

Observación

Si utiliza un grupo de tampones definidos por el usuario para la calibración, aparece el valor tampón introducido por Vd. Asegúrese de utilizar el tampón adecuado. La temperatura del tampón debe atenerse al valor introducido. Cuando se trabaja con sonda y la diferencia entre temperatura medida y valor introducido supera 1 °C, aparece Err 5 en el indicador.

6.4 Calibración

6.4.1 Calibración a 1 punto

Introduzca el electrodo en un tampón de calibración y pulse .

El pH-metro SevenEasy alcanza automáticamente durante la calibración al punto final. Para alcanzar el punto final manualmente, pulse la tecla . El instrumento señala el valor correspondiente del tampón y se detiene en él. Aparece indicado el valor de offset del electrodo.

Para volver a la medición de muestra, pulse .

6.4.2 Calibración de 2 puntos

Paso 1° Efectúe una "calibración de 1 punto", como se ha explicado antes.

Paso 2° Lave el electrodo con agua destilada.

Paso 3° Introduzca el electrodo en el tampón siguiente y pulse .

El pH-metro SevenEasy alcanza automáticamente durante la calibración al punto final. Para alcanzar manualmente al instrumento al punto final, pulse . El instrumento señala el valor tampón correspondiente y se detiene en él. Se actualiza al valor offset del electrodo y se indica la pendiente.

Para volver a la medición de la muestra, pulse .

6.4.3 Calibración de 3 puntos

Realice una "calibración de 2 puntos" como anteriormente. Repita los pasos 2 y 3 para la calibración de 3 puntos.



Observación

Se recomienda utilizar una sonda de temperatura o un electrodo con sonda de temperatura integrada. Si recurre al modo MTC, todos los tampones y soluciones de la muestra deben mantenerse a la misma temperatura regulada.

A fin de obtener una medida de pH lo más exacta posible, se debe calibrar periódicamente el instrumento.















Para visualizar el número y el tipo de tampón usado en la calibración, pulsar y mantener pulsada la tecla  durante 2 segundos. Aparecen sucesivamente los valores de los tampones.

7. Test de autocontrol

Mantenga pulsadas las dos teclas  y  al mismo tiempo, hasta que aparezca el símbolo del autotest .

En el instrumento aparece primero la indicación completa. A continuación parpadean sucesivamente los distintos símbolos. Luego hay que comprobar las teclas con la intervención del usuario.

Cuando parpadee el símbolo , pulse la tecla correspondiente antes de 5 segundos, de acuerdo con la lista siguiente



- Si parpadea  , pulse la tecla .
- Si parpadea , pulse la tecla .
- Si parpadea   , pulse la tecla .
- Si parpadea  , pulse la tecla .
- Si parpadea   °C, pulse la tecla .

Cuando el test de autocontrol está terminado aparece la señal  en el indicador. Si el autocontrol es negativo, consulte bajo "9. Mensajes de error" y adopte las medidas necesarias.

8. Operación con pilas opcional

El pH-metro SevenEasy permite el funcionamiento opcional con pilas. Introduzca 4 pilas AA (LR6) en la parte inferior del instrumento. Al retirar el cable de alimentador del instrumento, éste pasa a la operación con pilas y aparece el símbolo .

Cuando las pilas están descargadas aparece el símbolo  en el indicador.

En la operación con pilas el instrumento dispone de una función de desactivación automática. Si durante 10 minutos no se pulsa ninguna tecla, el instrumento se desactiva automáticamente para proteger las pilas. Para salir de esta función de desactivación automática, mantenga pulsada la tecla  durante 2 segundos hasta que aparezca el símbolo .

9. Mensajes de error

Error 1 - Offset excede el intervalo permitido

Asegúrese de que el tampón es el adecuado y reciente. Limpie o sustituya el electrodo.

Error 2 - La pendiente excede el intervalo permitido

Asegúrese de que el tampón es el adecuado y reciente. Limpie o sustituya el electrodo.

Error 3 - El instrumento no reconoce el tampón

Asegúrese de que el tampón es el adecuado y reciente. Verifique que no se ha usado dos veces para la calibración.

Error 4 - Error de entrada del valor tampón definido por el usuario

Cuando Vd. introduce valores tampones definidos por el usuario, el instrumento no acepta valores de pH inferiores en 1 unidad en los valores definidos por el usuario. Introduzca un valor nuevo.

Error 5 - La temperatura ATC se desvía del valor definido por el usuario.

La temperatura del tampón o de la muestra deben corresponder a la temperatura introducida. Si hiciera falta, cambie el ajuste de temperatura.

Error 6 - La temperatura de tampón medida excede el intervalo permitido (5...50 °C)

La temperatura del tampón debe mantenerse dentro del rango permitido.

Error 7, (—) - El valor mV excede el intervalo de medida

Asegúrese de que el electrodo está conectado.

Si el electrodo no está conectado, introduzca la horquilla cortacircuito.

Error 8 - El valor pH excede el intervalo de medida

Compruebe que el capuchón protector del electrodo está quitado y que el electrodo se encuentra correctamente conectado y sumergido en la muestra.

Error 9 - Test de autocontrol negativo

Repita el test de autocontrol y cerciórese de haber pulsado las teclas adecuadas cuando parpadee el símbolo . Si sigue apareciendo Err 9, póngase en contacto con el servicio METTLER TOLEDO.

10. Mantenimiento

10.1 Mantenimiento del instrumento

Ni las piezas de este instrumento ni las del alimentador son sustituibles por el usuario. Por favor, no abra la carcasa.

El SevenEasy no necesita mantenimiento alguno, a excepción de una limpieza ocasional con paño húmedo. La carcasa es de ABS/PC, que resistente a algunos disolventes orgánicos como tolueno, xileno y metiletilcetona. La buena práctica de laboratorio requiere la inmediata eliminación de los líquidos derramados.

10.2 Mantenimiento del electrodo

Asegúrese de que el electrodo está siempre lleno de electrolito. Para obtener máxima exactitud, cualquier solución añadida que "resbale" hacia fuera y pueda formar costra sobre el electrodo, debe ser eliminada con agua destilada.

Guarde el electrodo siempre en condiciones adecuadas, y no lo deje secar.

Si el valor de pendiente del electrodo disminuye rápidamente, la reacción se hace lenta, o las mediciones imprecisas, las operaciones siguientes pueden resultar útiles. Aplíquelas en este mismo orden:

1. Desengrasar la membrana con algodón empapado en acetona o solución jabonosa.
2. Sumerja la punta del electrodo durante la noche en 0.1 M HCl.
3. Si se origina formación proteínica, eliminar los residuos metiendo el electrodo en una solución de HCl/pepsina (nº de pedido: 51340068).
4. En caso de contaminación con sulfuro de plata, sumergir el electrodo en una solución de tiourea (nº de pedido: 51340070).

Observación

Las soluciones de limpieza y de relleno han de manipularse con las mismas precauciones que las sustancias tóxicas o corrosivas.

10.3 Eliminación de residuos



De conformidad con las exigencias de la directiva europea 2002/96/CE sobre residuos de aparatos eléctricos y electrónicos (RAEE), este equipo no puede eliminarse como basura doméstica. Esta prohibición es asimismo válida para los países que no pertenecen a la UE cuyas normativas nacionales en vigor así lo reflejan.

Elimine este producto, según las disposiciones locales, mediante el sistema de recogida selectiva de aparatos eléctricos y electrónicos.

Si tiene alguna pregunta al respecto, diríjase a las autoridades responsables o al distribuidor que le proporcionó el equipo.

Si transfiere este equipo (por ejemplo, para la continuación de su uso con fines privados, comerciales o industriales), deberá transferir con él esta disposición.

Muchas gracias por su contribución a la conservación medioambiental.

11. Accesorios

	N° de ped.
Brazo portaelectrodos completo	51302820
Guide to pH measurement (English)	51300047
Guide to conductivity and dissolved oxygen (English)	51724716
Guide to ion selective measurement (English)	51300075
Tampón pH 4,01, 30 bolsas de 20mL	51302069
Tampón pH 4,01, 6 frascos de 250mL	51340058
Tampón pH 7,00, 30 bolsas de 20mL	51302047
Tampón pH 7,00, 6 frascos de 250mL	51340060
Tampón pH 9,21, 30 bolsas de 20mL	51302070
Tampón pH 9,21, 6 frascos de 250mL	51300194
Tampón pH 10,01, 30 bolsas de 20mL	51302079
Tampón pH 10,01, 6 frascos de 250mL	51340231
InLab®410, electrodo de pH, sonda de temperatura, rellenable	52000118
InLab®412, electrodo de pH de laboratorio, vidrio, rellenable	52000112
InLab®413, electrodo de pH robusto, cuerpo de PEEK, ATC	52000100
InLab®420, electrodo de pH con diafragma esmerilado de PTFE	52000113
Solución de HCl/pepsina (elimina restos proteínicos)	51340068
Solución de tiourea (elimina restos de sulfuro de plata)	51340070
Solución de reactivación para electrodos de pH	51340073

12. Características técnicas

	pH	mV	Temperatura			
Intervalo de medida	0,00 -14,00	± 1999	-5 ... 105 °C			
Resolución	0,01	1	0,1 °C			
Exactitud relativa	± 0,01	± 1	± 0,5 °C			
Calibración de pH	1, 2, ó 3 puntos					
Punto isopotencial	7,00 pH					
Tampónes de calibración	B1: (25 °C)	7,00	4,00	10,01	1,68	
	B2: (25 °C)	7,00	4,01	9,21	2,00	11,00
	B3: (20 °C)	7,00	4,00	9,00	2,00	12,00
	B4: (25 °C)	6,86	4,01	9,18	1,68	
	B5: definido por el usuario					
Compensación de temperat.	-5 ... 105 °C automática o manual					
Indicador	de cristal líquido					
Salidas	RS232 serie, Vel. de transmisión: 1200 baudios Bits de datos: 8 Bits de parada: 1 Paridad: no					
Entrada pH	Impedancia > 10 ¹² ohmios					
Condiciones ambientales	Temperatura ambiente: 5 °C ... 40 °C Humedad rel. del aire: 5 % ... 80 %, (sin condensación) Categ.de sobrevoltaje: II Grado de contaminación: 2					
Dimensiones/peso	180 x 180 x 65 (mm) / 0,61 kg					
Material	Carcasa: ABS, reforzado con PC Portaelectrodo: ABS, reforzado con PC Tarjeta del teclado: Polyester					
Alimentación eléctrica	El pH-metro SevenEasy va provisto de un alimentador apropiado para su región: - EEUU: 120 V / 60 Hz, 10 VA, 9 V DC - Europa: 230 V / 50 Hz, 10 VA, 9 V DC - Reino Unido: 240 V / 50 Hz, 10 VA, 9 V DC - Japón: 110 V / 50 Hz, 10 VA, 9 V DC - Australia: 240 V / 50 Hz, 10 VA, 9 V DC - China: 220 V / 50 Hz, 10 VA, 9 V DC - Pilas (opcionales): 4 x AA (LR6)					

Observación

El pH-metro SevenEasy sólo debe operar con el alimentador suministrado, o con pilas.

13. Quick Guide

1. Preparar electrodo



2. Calibración a 1 punto

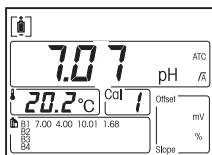

punto final automático,
o bien

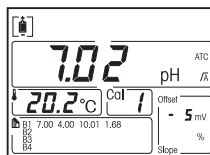

3. Lavar electrodo

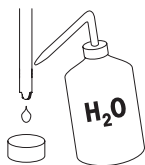

4. Calibración de 2 ó 3 puntos

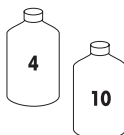

Repita el paso 2 para una calibración a 2 ó 3 puntos, luego lave

5. Medir muestra



punto final automático,
o bien

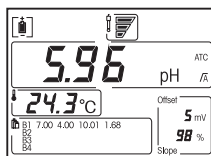

6. Lavar electrodo

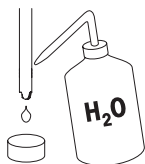

7. Guardar electrodo



14. Grupo de tampones

El pH-metro SevenEasy compensa automáticamente la temperatura ajustada con arreglo a los valores de las tablas:

Grupo tampones 1 (ref. 25 °C) MT USA

5	7,09	4,00	10,25	1,67
10	7,06	4,00	10,18	1,67
15	7,04	4,00	10,12	1,67
20	7,02	4,00	10,06	1,68
25	7,00	4,00	10,01	1,68
30	6,99	4,01	9,97	1,68
35	6,98	4,02	9,93	1,69
40	6,97	4,03	9,89	1,69
45	6,97	4,04	9,86	1,70
50	6,97	4,06	9,83	1,71

Grupo tampones 2 (ref. 25 °C) MT EU

5	7,09	4,01	9,45	2,02	11,72
10	7,06	4,00	9,38	2,01	11,54
15	7,04	4,00	9,32	2,00	11,36
20	7,02	4,00	9,26	2,00	11,18
25	7,00	4,01	9,21	2,00	11,00
30	6,99	4,01	9,16	1,99	10,82
35	6,98	4,02	9,11	1,99	10,64
40	6,97	4,03	9,06	1,98	10,46
45	6,97	4,04	9,03	1,98	10,28
50	6,97	4,06	8,99	1,98	10,10

Grupo tampones 3 (ref. 20 °C) Tampones Merck

5	7,07	4,04	9,16	2,01	12,41
10	7,05	4,02	9,11	2,01	12,26
15	7,02	4,01	9,05	2,00	12,10
20	7,00	4,00	9,00	2,00	12,00
25	6,98	4,01	8,95	2,00	11,88
30	6,98	4,01	8,91	2,00	11,72
35	6,96	4,01	8,88	2,00	11,67
40	6,95	4,01	8,85	2,00	11,54
45	6,95	4,01	8,82	2,00	11,44
50	6,95	4,00	8,79	2,00	11,33

Grupo tampones 4 (ref. 25 °C) Japón JIS

5	6,95	4,00	9,40	1,67
10	6,92	4,00	9,33	1,67
15	6,90	4,00	9,28	1,67
20	6,88	4,00	9,22	1,68
25	6,86	4,01	9,18	1,68
30	6,85	4,02	9,14	1,68
35	6,84	4,02	9,10	1,69
40	6,84	4,04	9,07	1,69
45	6,83	4,05	9,04	1,70
50	6,83	4,06	9,01	1,71

Indice del contenuto

1.	Introduzione	3
2.	Misure di sicurezza	3
	Misure per la protezione dell'utente	3
	Misure per la sicurezza di funzionamento	3
3.	Descrizione dello strumento	4
	3.1 Indicatore	4
	3.2 Tastiera	5
4.	Installazione	6
5.	Misurazione campioni	8
	5.1 Misurazione di pH	8
	5.2 Misurazione di mV	8
	5.3 Regolazioni	8
	5.3.1 ATC	8
	5.3.2 MTC	8
	5.3.3 Emissione dati	8
6.	Calibrazione	9
	6.1 Regolazioni	9
	6.2 Selezione di un gruppo di tamponi predefinito	9
	6.3 Impostazione di un gruppo di tamponi definito dall'utente	9
	6.3 Calibrazione	10
	6.3.1 Calibrazione a 1 punto	10
	6.3.2 Calibrazione a 2 punti	10
	6.3.3 Calibrazione a 3 punti	10
7.	Autodiagnosi	11
8.	Funzionamento opzionale con alimentazione a batterie	11
9.	Messaggi d'errore	12
10.	Manutenzione	13
	10.1 Manutenzione dello strumento	13
	10.2 Manutenzione dell'elettrodo	13
	10.3 Smaltimento	13
11.	Accessori	14
12.	Specifiche tecniche	15
13.	Guida Rapida	16
14.	Gruppi di tamponi	17

1. Introduzione

SevenEasy – uno strumento che soddisfa le vostre esigenze ben oltre la pura misurazione del pH, senza sovraccaricare inutilmente il vostro budget. Uno strumento che offre molti vantaggi:

- L'interfaccia utente è concepita in maniera tale da rendere non più necessaria la consultazione del manuale di utilizzo. In questo modo risparmiate molto tempo.
- Grazie all'alimentazione a batteria, lo strumento può essere rapidamente installato e montato su un altro tavolo da laboratorio, o persino in un altro laboratorio, anche in luoghi in cui non è possibile utilizzare l'alimentazione da rete.
- Le prestazioni di servizio consentono una regolare qualificazione del vostro strumento e ne migliorano l'affidabilità e la precisione.

2. Misure di sicurezza

Misure per la protezione dell'utente



- Mai lavorare in un ambiente a rischio d'esplosione. Lo chassis dello strumento non è a tenuta di gas. Vi è un rischio di esplosione in caso di scintille e/o un rischio di corrosione in presenza di gas).



- In caso di utilizzo di agenti chimici e solventi, attenersi alle istruzioni del produttore ed alle normative a carattere generale in tema di sicurezza in laboratorio.

Misure per la sicurezza di funzionamento



- Fare eseguire la manutenzione solo dal personale dell'Assistenza METTLER TOLEDO.
- Asciugare subito eventuali spruzzi di liquido. Lo strumento non è a tenuta d'acqua.
- Usare solo batterie del tipo specificato. In caso contrario, non può essere garantito il corretto funzionamento dello strumento.
- Eliminare le seguenti influenze ambientali:
 - forti vibrazioni
 - esposizione diretta alla luce solare,
 - umidità atmosferica superiore all'80%,
 - presenza di gas corrosivi nell'atmosfera,
 - temperature inferiori a 5 °C e superiori a 40 °C,
 - campi elettrici o magnetici di forte intensità.

3. Descrizione dello strumento

3.1 Indicatore

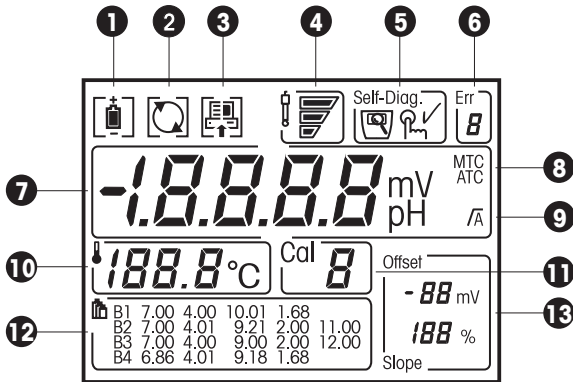

1 Stato della batteria

2 Disattivazione autospegnimento automatico durante il funzionamento a batterie

3 Trasferimento dati al PC/Stampante

4 Stato dell'elettrodo



Pendenza: 95 - 105 %
Offset: \pm (0-15) mV
L'elettrodo è in
buono stato



Pendenza: 90 - 94 %
Offset: \pm (15 - 35) mV
L'elettrodo deve
L'elettrodo deve



Pendenza: 85 - 89 %
Offset: \pm (>35) mV
L'elettrodo è difettoso

5 Autodiagnosi dello strumento



Indicatore
autodiagnosi



Richiesta di
premere un tasto



Autodiagnosi
superata

6 Codice errore

7 Misurazione pH/mV

8 Compensazione temperatura in automatico/manuale

9 Stabilità punto finale/punto finale in automatico



Stabilità punto finale



Punto finale automatico

10 Temperatura

11 Punto di calibrazione

12 Gruppi di tamponi





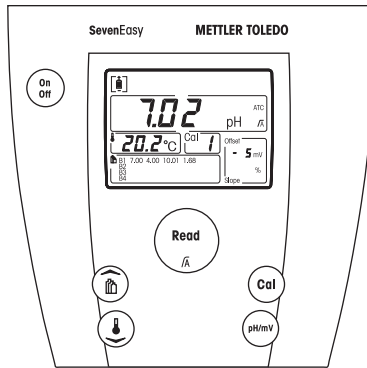





13 Punto zero e pendenza dell'elettrodo

3.2 Tastiera



Premere e rilasciare

Premere e tenere pre- muto per 2 secondi

	Misuratore on/off	Disattivazione autospegnimento con funzionamento a batterie 
	<ul style="list-style-type: none"> - Misurazione punto iniziale o finale - Ritorno al modo misurazione - Memorizzazione valore introdotto 	Attivaz./disattivaz. punto finale autom. 
	<ul style="list-style-type: none"> - Inizio calibrazione - Conferma gruppo di tamponi selezionato 	Indicatore delle soluzioni tempomane impiegate per la calibrazione.
	Commutazione tra modo misurazione pH e mV	Trasferimento dati al PC o alla stampante 
	<ul style="list-style-type: none"> - Selezione gruppi di tamponi calibrazione - Aumento valore durante l'impostazione 	
	<ul style="list-style-type: none"> - Impostazione temperatura MTC - Riduzione valore durante l'impostazione 	
	Avvio autodiagn. 	

4. Installazione

1. Disimballare lo strumento, l'alimentatore, l'elettrodo, il braccio dell'elettrodo e gli altri accessori. Conservare il certificato di calibrazione in un luogo sicuro.
2. Accertarsi che la tensione indicata sull'alimentatore corrisponda a quella della rete di alimentazione. Altrimenti, contattare il rivenditore METTLER TOLEDO.
3. Installare il braccio dell'elettrodo.

- Il portaelettrodo può essere utilizzato da solo oppure può essere montato sullo strumento. Il braccio dell'elettrodo deve essere posizionato in una delle tre posizioni sul supporto. Se il portaelettrodo viene usato da solo, si raccomanda di usare la posizione intermedia. Per prima cosa, rimuovere il coperchio corrispondente. Utilizzare la vite di fissaggio fornita per bloccare il braccio in posizione. Se si utilizza il portaelettrodo da solo, l'installazione è terminata.

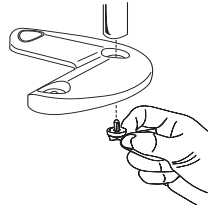

- Per fissare il portaelettrodo allo strumento, posizionare il supporto in modo tale che l'ala del supporto non occupata risulti rivolta verso il basso dello strumento. Per prima cosa, rimuovere il coperchio corrispondente. Il portaelettrodo può essere fissato sul lato sinistro oppure sul lato destro.

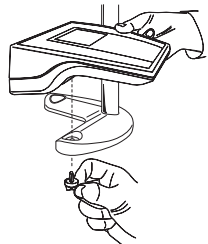

- Regolare la vite di fissaggio secondo necessità.

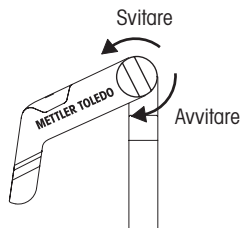

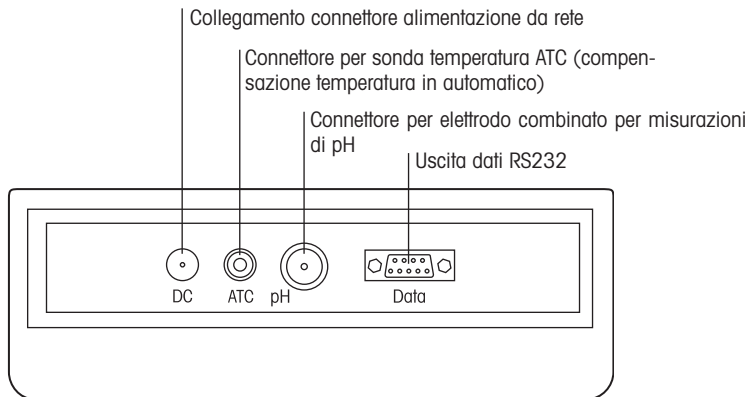

4. Scollegare le pinze di corto circuito dal connettore pH.
5. Collegare l'elettrodo. Se si usa un elettrodo con sonda di temperatura integrata, collegare l'altro cavo al connettore ATC.
6. Se si usa una sonda di temperatura separata, collegarla al connettore ATC.
7. Collegare l'alimentatore al connettore di alimentazione elettrica a corrente continua (CC).



5. Misurazione campioni

5.1 Misurazione di pH

Immergere l'elettrodo nel campione e premere  per avviare la misurazione, il punto decimale lampeggia.

L'indicatore mostra il valore di pH del campione, e il punto finale in automatico **A** è l'impostazione di default del misuratore. Appena i dati trasmessi dal sensore si stabilizzano, l'indicatore si blocca automaticamente e visualizza l'icona .

Il algoritmo del punto finale automatico è 0,1 mV per 5 secondi.

Tenendo premuto il tasto , è possibile commutare tra il modo a punto finale in automatico e manuale. Per introdurre manualmente il punto finale per una misurazione, premere il tasto . L'indicatore si blocca e visualizza l'icona .

5.2 Misurazione di mV

Per effettuare misurazioni di mV, seguire la stessa procedura prevista per le misurazioni di pH. Per visualizzare il valore mV durante le misurazioni di pH, premere il tasto .

5.3 Regolazioni

5.3.1 ATC

Per una maggiore precisione, si raccomanda l'uso di una sonda di temperatura integrata o separata. Se si utilizza una sonda di temperatura, sull'indicatore vengono visualizzati il simbolo **ATC** e la temperatura del campione.



5.3.2 MTC

Se lo strumento non rileva una sonda di temperatura collegata, esso commuta automaticamente al modo di compensazione della temperatura manuale, e l'indicatore visualizza il simbolo **MTC**.

Per impostare la temperatura MTC, premere il tasto . Utilizzare i tasti  e , per aumentare o ridurre il valore di temperatura, premere il tasto  per confermare la regolazione effettuata. L'impostazione di default è pari a 25 °C.

5.3.3 Emissione dati

Se lo strumento è collegato ad un PC o ad una stampante, ciascuna misurazione del punto finale viene trasmessa al PC o alla stampante tramite il connettore RS232.

Premendo e tenendo premuto il tasto , l'indicatore visualizza l'icona . Lo strumento trasmette una misurazione al secondo, fino a quando viene raggiunto il punto finale.

6. Calibrazione

6.1 Regolazioni

Il misuratore di pH SevenEasy consente di effettuare calibrazioni a 1, 2 e 3 punti. Quando si seleziona un gruppo di tamponi di calibrazione tra i quattro gruppi preimpostati nell'strumento, durante la calibrazione lo strumento effettua il riconoscimento automatico del gruppo di tamponi.

I 4 gruppi di tamponi preimpostati sono:

B1: (25 °C)	7,00	4,00	10,01	1,68	
B2: (25 °C)	7,00	4,01	9,21	2,00	11,00
B3: (20 °C)	7,00	4,00	9,00	2,00	12,00
B4: (25 °C)	6,86	4,01	9,18	1,68	





Seguendo la procedura di regolazione tampone descritta sotto, l'utente può definire un proprio gruppo di tamponi personalizzato. Durante la calibrazione, il riconoscimento automatico del tampone non è attivo.



6.2 Selezione di un gruppo di tamponi predefinito

Premere il tasto , il tampone corrente inizia a lampeggiare. Se il gruppo di tamponi corrente è un gruppo definito dall'utente, il campo vuoto lampeggia.

Usare il tasto  o  per selezionare altri gruppi nella posizione superiore o inferiore. Quando il gruppo desiderato lampeggia, premere il tasto  per confermare la selezione.

6.3 Impostazione di un gruppo di tamponi definito dall'utente

Se al punto 6.2, il campo vuoto lampeggia, premere il tasto , per avviare l'impostazione. Lo strumento visualizza il valore di temperatura corrente impostato, mentre il punto e il campo lampeggiano (la temperatura di default è 25 °C). Usare il tasto  o  per modificare il valore. Premere il tasto  per memorizzare il valore e continuare.

Dopo avere impostato il valore della temperatura, lo strumento visualizza l'impostazione corrente del primo tampone di calibrazione (valore di default 4.00). Usare il tasto  o , per modificare il valore. Premere il tasto  per memorizzare il valore e continuare.

Dopo aver impostato il primo tampone di calibrazione, premere il tasto  per avviare la regolazione del punto successivo.

La procedura è identica a quella prevista per il primo punto. È possibile impostare fino a 3 tamponi di calibrazione definiti dall'utente. Dopo aver completato le impostazioni, premere il tasto  per uscire dal menu.

Nota

Se per la calibrazione si utilizza un gruppo di tamponi definito dall'utente, l'indicatore visualizzerà il valore del tampone che Lei ha impostato. Accertarsi che si stia utilizzando il tampone corretto. Inoltre, mantenere la temperatura del tampone al valore impostato. Se si installa una sonda di temperatura e la temperatura misurata differisce di oltre 1 grado rispetto al valore impostato, l'indicatore visualizza il messaggio Err 5.

6.3 Calibrazione

6.3.1 Calibrazione a 1 punto

Immergere l'elettrodo in un tampone di calibrazione e premere il tasto .

Durante la calibrazione, il misuratore di pH SevenEasy raggiunge automaticamente il punto finale. Per raggiungere manualmente il punto finale, premere il tasto . Lo strumento indica il valore del tampone corrispondente, e si ferma. L'indicatore mostra il punto zero dell'elettrodo.

Per tornare alla misurazione del campione, premere il tasto .

6.3.2 Calibrazione a 2 punti

Passo 1. Eseguire una "Calibrazione a 1 punto" come descritto sopra.

Passo 2. Lavare l'elettrodo con acqua distillata.

Passo 3. Immergere l'elettrodo nel tampone di calibrazione successivo e premere .

SevenEasy raggiunge automaticamente il punto finale. Per raggiungere manualmente il punto finale, premere il tasto . Lo strumento indica il valore del tampone corrispondente, e si ferma. Il punto zero dell'elettrodo viene aggiornato e l'indicatore visualizza la pendenza.

Per tornare alla misurazione del campione, premere il tasto .

6.3.3 Calibrazione a 3 punti



Effettuare una "Calibrazione a 2 punti" secondo quanto descritto sopra. Per la calibrazione a 3 punti, ripetere i passi 2 e 3.

Nota

Si raccomanda l'uso di una sonda di temperatura o di un elettrodo con sonda di temperatura integrata. Se si utilizza il modo MTC, conservare tutte le soluzioni tampone e campione alla temperatura impostata. Per garantire la massima precisione possibile della misurazione del pH, è necessario effettuare la calibrazione dello strumento a intervalli di tempo regolari.











Per indicare il numero e il tipo delle soluzioni tampone impiegate per la calibrazione, premere e mantenere premuto il tasto  per 2 secondi. I valori delle soluzioni tampone sono indicati in alternanza.

7. Autodiagnosi

Premere e tenere premuti contemporaneamente entrambi i tasti  e  fino a quando sull'indicatore compare l'icona  di autodiagnosi del misuratore.

Sullo strumento compare prima lo schermo intero, poi le singole icone lampeggiano una dopo l'altra. Infine, è necessario che l'utente verifichi il corretto funzionamento dei tasti.

Quando lampeggia l'icona , entro 5 secondi premere il tasto corrispondente, come indicato nel seguente elenco:



- Quando lampeggia l'icona , premere il tasto .
- Quando lampeggia l'icona , premere il tasto .
- Quando lampeggia l'icona , premere il tasto .
- Quando lampeggia l'icona , premere il tasto .
- Quando lampeggia l'icona  °C, premere il tasto .

Una volta conclusa l'autodiagnosi, nell'indicatore compare un segno di spunta ✓. Se l'autodiagnosi fallisce, consultare il paragrafo "9. Messaggi d'errore", e adottare le misure necessarie.

8. Funzionamento opzionale con alimentazione a batterie

Il misuratore di pH SevenEasy consente il funzionamento opzionale con alimentazione a batterie. Installare 4 batterie tipo AA (LR6) sul retro dello strumento. Se il cavo dell'alimentatore non è collegato, lo strumento funziona con alimentazione a batterie e sull'indicatore compare l'icona .

Quando le batterie sono scariche, nell'indicatore compare l'icona .

Durante il funzionamento con alimentazione a batterie, lo strumento dispone di una funzione di auto-spegnimento. Se per 10 minuti l'utente non preme alcun tasto, lo strumento si spegne automaticamente per risparmiare le batterie. Per disattivare la funzione di autospegnimento, tenere premuto il tasto  per 2 secondi, fino a quando nell'indicatore compare l'icona .

9. Messaggi d'errore

Errore 1 - Valore punto zero al di fuori dell'intervallo consentito

Accertarsi che si stia usando il tampone corretto e che lo stesso sia fresco. Pulire l'elettrodo oppure sostituirlo.

Errore 2 - Pendenza al di fuori dell'intervallo consentito

Accertarsi che si stia usando il tampone corretto e che lo stesso sia fresco. Pulire l'elettrodo oppure sostituirlo.

Errore 3 - Lo strumento non riconosce il tampone

Accertarsi che si stia usando il tampone corretto e che lo stesso sia fresco. Verificare se il tampone è stato utilizzato più volte per la calibrazione.

Errore 4 - Errore introduzione valore gruppo di tamponi definito dall'utente

Se l'utente introduce il valore del gruppo di tamponi definito dall'utente, lo strumento non accetta valori di pH inferiori, di più di un'unità di pH, rispetto ai valori definiti. Introdurre un nuovo valore.

Errore 5 - Temperatura ATC differisce dal valore definito dall'utente

Mantenere il tampone o il campione alla temperatura impostata. Se necessario, modificare l'impostazione della temperatura.

Errore 6 - Temperatura misurata del tampone al di fuori dell'intervallo consentito (5... 50°C)

Mantenere la temperatura del tampone entro l'intervallo.

Errore 7, (----) - Valore mV al di fuori dell'intervallo di misurazione

Accertarsi che l'elettrodo sia collegato.

Se nessun elettrodo è collegato, inserire le pinze di corto circuito nel connettore.

Errore 8 - Valore di pH al di fuori dell'intervallo di misurazione

Verificare se il coperchio dell'elettrodo è stato rimosso e se l'elettrodo è collegato e immerso correttamente in una soluzione campione.

Errore 9 - Autodiagnosi fallita

Ripetere la procedura di autodiagnosi ed accertarsi di aver premuto i tasti corretti mentre l'icona  lampeggiava. Se nell'indicatore compare nuovamente il messaggio Err 9, contattare il Servizio Assistenza METTLER TOLEDO.

10. Manutenzione

10.1 Manutenzione dello strumento

Né lo strumento, né l'alimentatore contengono parti che possono essere sostituite dall'utente. Non aprire lo chassis.

Il SevenEasy non richiede alcun intervento di manutenzione eccetto la pulizia occasionale, che dev'essere effettuata con un panno umido. Lo chassis è costituito da ABS/PC, che può essere corroso da alcuni solventi organici, come toluene, xilene, metiletilchetone. È buona pratica di laboratorio asciugare immediatamente eventuali spruzzi.

10.2 Manutenzione dell'elettrodo

Accertarsi che l'elettrodo sia sempre riempito con la soluzione di riempimento. Per ottenere la massima precisione possibile, rimuovere con acqua distillata eventuali residui di soluzione di riempimento, che potrebbero essersi "infiltrati" ed essere rimasti incrostati sulla superficie esterna dell'elettrodo.

Conservare sempre in modo adeguato l'elettrodo e non farlo asciugare.

Se il valore di pendenza dell'elettrodo diminuisce rapidamente, il tempo di reazione aumenta o le misurazioni divengono imprecise, le seguenti procedure possono essere di aiuto. Esse devono essere eseguite nell'ordine indicato.

1. Sgrassare la membrana con lana di cotone impregnata con soluzione di acetone/sapone.
2. Tenere la punta dell'elettrodo immersa in HCl 0,1 M HCl per una notte.
3. In caso di formazione di proteine, rimuovere i depositi immergendo l'elettrodo in una soluzione di HCl/pepsina (Cod. Ord.: 51340068).
4. In caso di contaminazioni di solfuro d'argento, immergere l'elettrodo in una soluzione di tiourea (Cod. Ord.: 51340070).

Nota

Maneggiare le soluzioni per la pulizia ed il riempimento con la medesima cura prestata per le sostanze tossiche o corrosive.

10.3 Smaltimento



In conformità a quanto stabilito dalla Direttiva Europea 2002/96 CE in materia di apparecchi elettrici ed elettronici (RAEE), questo strumento non può essere smaltito come i normali rifiuti. Tale presupposto resta valido anche per i Paesi al di fuori dei confini della UE, conformemente alle norme nazionali in vigore.

Si prega quindi di smaltire questo prodotto separatamente e in modo specifico secondo le disposizioni locali relative alle apparecchiature elettriche ed elettroniche.

Per qualsiasi chiarimento, rivolgersi agli enti preposti o al rivenditore dell'apparecchiatura stessa.

In caso di cessione dello strumento (per es. per ulteriore utilizzo privato o aziendale/industriale), si prega di comunicare anche questa disposizione.

Si ringrazia per il contributo alla tutela dell'ambiente.

11. Accessori

	Cod. Ord.
Braccio elettrodo completo	51302820
Guide to pH measurement (English)	51300047
Guide to conductivity and dissolved oxygen (English)	51724716
Guide to ion selective measurement (English)	51300075
Sacchetti tampone pH 4,01 30 x 20mL	51302069
Flaconi tampone pH 4,01, 6 x 250mL	51340058
Sacchetti tampone pH 7,00, 30 x 20mL	51302047
Flaconi tampone pH 7,00, 6 x 250mL	51340060
Sacchetti tampone pH 9,21, 30 x 20mL	51302070
Flaconi tampone pH 9,21, 6 x 250mL	51300194
Sacchetti tampone pH 10,01, 30 x 20mL	51302079
Flaconi tampone pH 10,01, 6 x 250mL	51340231
InLab®410, Elettrodo pH, sonda temperatura, rabboccabile	52000118
InLa®b412, Elettrodo pH da laboratorio, bicchiere, rabboccabile	52000112
InLab®413, Elettrodo pH robusto, corpo in PEEK, ATC	52000100
InLab®420, Elettrodo pH con diaframma in PTFE	52000113
Soluzione HCl/pepsina (rimuove le contaminazioni dovute a proteine)	51340068
Soluzione di tiourea (rimuove le contaminazioni di solfuro d'argento)	51340070
Soluzione di rigenerazione per elettrodi pH	51340073

12. Specifiche tecniche

	pH	mV	Temperatura		
Intervallo di misura	0,00 - 14,00	± 1999	-5 ... 105 °C		
Risoluzione	0,01	1	0,1 °C		
Precisione relativa	± 0,01	± 1	± 0,5 °C		
Calibrazione pH	Punti 1, 2, o 3				
Punto isopotenziale	7,00 pH				
Tamponi di calibrazione	B1: (25 °C)	7,00	4,00	10,01	1,68
	B2: (25 °C)	7,00	4,01	9,21	2,00 11,00
	B3: (20 °C)	7,00	4,00	9,00	2,00 12,00
	B4: (25 °C)	6,86	4,01	9,18	1,68
	B5: definito dall'utente				
Compensazione temperatura	da -5 ... 105 °C in automatico o manuale				
Indicatore	Indicatore a cristalli liquidi				
Uscite	RS232 seriale, Velocità di trasmissione: 1200 Bit di dati: 8 Bit di stop: 1 Parità: nessuna				
Ingresso pH	Impedenza > 10 ¹² Ohm				
Condizioni ambientali	Temperatura ambiente: 5 °C ... 40 °C Umidità relativa: 5 % ... 80 %, (senza condensa) Categoria di sovratensione: II Grado di inquinamento: 2				
Dimensioni/Peso	180 x 180 x 65 (mm) / 0,61 kg				
Materiali	Chasis: ABS, rinforzato PC Portaelettrodo: ABS, rinforzato PC Membrana tastiera: Poliestere				
Alimentazione elettrica	Il misuratore di pH SevenEasy è dotato di un alimentatore appropriato per la rete di alimentazione del luogo di installazione: - Stati Uniti: 120 V / 60 Hz, 10 VA, 9 V DC - Europa: 230 V / 50 Hz, 10 VA, 9 V DC - Regno Unito: 240 V / 50 Hz, 10 VA, 9 V DC - Giappone: 110 V / 50 Hz, 10 VA, 9 V DC - Australia: 240 V / 50 Hz, 10 VA, 9 V DC - Cina: 220 V / 50 Hz, 10 VA, 9 V DC - Batterie (facolt.): 4 x AA (LR6)				

Nota

Il misuratore di pH SevenEasy pH deve essere utilizzato soltanto con l'alimentatore in dotazione o con batterie.

13. Guida Rapida

1. Preparazione dell'elettrodo



Rimuovere il cappuccio

2. Calibrazione a 1 punto

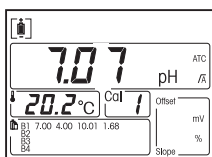

Punto finale in automatico o

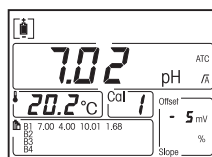

3. Lavaggio dell'elettrodo

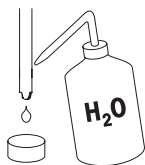

4. Calibrazione a 2 o 3 Punti

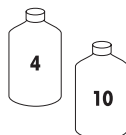

Per una calibrazione a 2 o 3 punti, ripetere il punto 2, quindi effettuare il lavaggio

5. Misurazione campione



Punto finale in automatico o

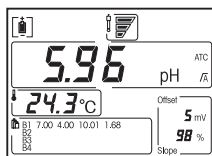

6. Lavaggio dell'elettrodo

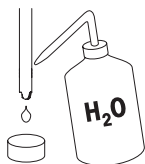

7. Conservazione dell'elettrodo



14. Gruppi di tamponi

Il misuratore di pH SevenEasy compensa automaticamente la temperatura impostata sulla base dei valori indicati nelle tabelle:

Gruppo di tamponi 1 (rif. 25 °C) MT USA

5	7,09	4,00	10,25	1,67
10	7,06	4,00	10,18	1,67
15	7,04	4,00	10,12	1,67
20	7,02	4,00	10,06	1,68
25	7,00	4,00	10,01	1,68
30	6,99	4,01	9,97	1,68
35	6,98	4,02	9,93	1,69
40	6,97	4,03	9,89	1,69
45	6,97	4,04	9,86	1,70
50	6,97	4,06	9,83	1,71

Gruppo di tamponi 2 (rif. 25 °C) MT Europa

5	7,09	4,01	9,45	2,02	11,72
10	7,06	4,00	9,38	2,01	11,54
15	7,04	4,00	9,32	2,00	11,36
20	7,02	4,00	9,26	2,00	11,18
25	7,00	4,01	9,21	2,00	11,00
30	6,99	4,01	9,16	1,99	10,82
35	6,98	4,02	9,11	1,99	10,64
40	6,97	4,03	9,06	1,98	10,46
45	6,97	4,04	9,03	1,98	10,28
50	6,97	4,06	8,99	1,98	10,10

Gruppo di tamponi 3 (rif. 20 °C) Tamponi Merck

5	7,07	4,04	9,16	2,01	12,41
10	7,05	4,02	9,11	2,01	12,26
15	7,02	4,01	9,05	2,00	12,10
20	7,00	4,00	9,00	2,00	12,00
25	6,98	4,01	8,95	2,00	11,88
30	6,98	4,01	8,91	2,00	11,72
35	6,96	4,01	8,88	2,00	11,67
40	6,95	4,01	8,85	2,00	11,54
45	6,95	4,01	8,82	2,00	11,44
50	6,95	4,00	8,79	2,00	11,33

Gruppo di tamponi 4 (ref. 25 °C) Giappone JIS

5	6,95	4,00	9,40	1,67
10	6,92	4,00	9,33	1,67
15	6,90	4,00	9,28	1,67
20	6,88	4,00	9,22	1,68
25	6,86	4,01	9,18	1,68
30	6,85	4,02	9,14	1,68
35	6,84	4,02	9,10	1,69
40	6,84	4,04	9,07	1,69
45	6,83	4,05	9,04	1,70
50	6,83	4,06	9,01	1,71

EC - DECLARATION OF CONFORMITY

KD-Nr.:

Doku-Nr.: 20030016

The undersigned, representing the following manufacturer

Mettler-Toledo GmbH (MTANA)
Sonnenbergstrasse 74
CH-8603 Schwerzenbach



herewith declares that the product

Electro chemical analytical meter
SevenEasy

For additional types, see page type code

certified model: --

is in conformity with the provisions of the following EC directives
(including all applicable amendments)

73/23/EEC	Low voltage (LVD)
89/336/EEC	Electromagnetic compatibility (EMC)

and that the standards have been applied.

Last two digits of the year in which the CE marking was affixed: **03**

CH-8603 Schwerzenbach
19.06.2003

.....
Bernhard Grob
General Manager

.....
Rolf Truttmann
Manager Business Area Analytical Chemistry

References of standards for this declaration of conformity, or parts thereof:
Harmonized standards of Europe and Switzerland:

Safety standards:

IEC/EN61010-1:2001

EMC standards:

EN61326-1:1997+A1:98 (class B)
EN61326:1997+A1:98 (Industrial environments)

Metrological standards:

--

IP standards:

--

Standards for Canada, USA and Australia

CAN/CSA-C22.2 No.1010.1-92
UL Std. No. 3101-1

FCC, Part 15, class A
AS/NZS4251.1, AS/NZS4252.1

EC - DECLARATION OF CONFORMITY

KD-Nr.:

Doku-Nr.: 20030016

Type code



other types of same construction:

SevenEasy
SevenEasy

ph meter (Outputs, software, keypads)
Conductivity meter (Outputs, software, keypads)

Remarks

EC - DECLARATION OF CONFORMITY

KD-Nr.:

Doku-Nr.: 20030016

Accessories



Power supply:

For use with an certified (CSA or equivalent) power supply, which must have a limited and SELV circuit output.

Mettler-Toledo delivers the product with one of the following power supply:

US CAN:

AC Adaptor (TJIN GOAN) Model:MDE090100UA4 120VAC 60Hz 240mA ; DC9V 1000mA
Class 2

UK:

AC Adaptor (TJIN GOAN) Model:MCDE090100BN4 240VAC 50Hz 120mA ; DC9V 1000mA

Euro:

AC Adapter (TJIN GOAN) Model:MCDE090100TH4 230VAC 50Hz 240mA; DC9V 1000mA

Japan:

AC Adapter (TJIN GOAN) Model:MDE090100UR 110VAC 50/60Hz 240mA; DC9V 1000mA

AUS:

AC Adapter (TJIN GOAN) Model:MCDE090100QN4 240VAC 50Hz 120mA; DC9V 1000mA

China:

AC Adapter (TJIN GOAN) Model:MCDE090100CF4 220VAC 50Hz 150mA; DC9V 1000mA



Quality certificate. Development, production and testing according to ISO9001.
Environmental management system according to ISO14001.



Worldwide service. Our extensive service network is among the best in the world and ensures maximum availability and service life of your product.



European conformity. The CE conformity mark provides you with the assurance that our products comply with the most recent EU directives.



On the Internet. You will quickly find lots of essential information about our products, our services, and our company at <http://www.mt.com>



P51710234

Subject to technical changes and to the availability of the accessories supplied with the instruments.

© Mettler-Toledo AG 2003, 2004, 2006 ME-51710234C Printed in China 0607/2.45

Mettler-Toledo AG, Analytical, Sonnenbergstrasse 74, CH-8603 Schwerzenbach,
Tel. +41 (0)44 806 77 11, Fax +41 (0)44 806 73 50, Internet: <http://www.mt.com>