



# Thermomixer compact / Thermomixer

Operating Manual

**eppendorf**



Copyright© 2008 Eppendorf AG, Hamburg. No part of this publication may be reproduced without the prior permission of the copyright owner.

**Trademarks**

eppendorf® and eppendorf Thermomixer® are registered trademarks of Eppendorf AG, Hamburg, Germany.

Thermomixer™ is a trademark of Eppendorf AG, Hamburg, Germany.

Falcon® is a registered trademark of Becton Dickinson, Franklin Lakes, USA.

Trademarks are not marked in all cases with ™ or ® in this manual.

## Table of contents

<b>1</b>	<b>User instructions</b>	<b>7</b>
1.1	Using this manual	7
1.2	Warning signs and hazard icons	7
1.3	Symbols used	7
1.4	Abbreviations used	7
<b>2</b>	<b>Product description</b>	<b>8</b>
2.1	Main illustration	8
2.2	Delivery package	8
2.3	Features	9
2.3.1	Thermomix compact	9
2.3.2	IsoTherm system (optional accessory)	9
<b>3</b>	<b>Safety</b>	<b>10</b>
3.1	Intended use	10
3.2	User profile	10
3.3	Note on product liability	10
3.4	Warnings for intended use	10
<b>4</b>	<b>Installation</b>	<b>13</b>
4.1	Preparing installation	13
4.2	Selecting location	13
4.3	Installing instrument	13
<b>5</b>	<b>Operation</b>	<b>14</b>
5.1	Overview of operating controls	14
5.2	Inserting tubes	14
5.3	Temperature control and mixing	15
5.3.1	Tempering	15
5.3.2	Operation without temperature control	15
5.3.3	Mixing	15
5.3.4	Short Mix	15
5.3.5	Save the values	15
<b>6</b>	<b>Troubleshooting</b>	<b>16</b>
6.1	General errors	16
6.2	Error messages	16
<b>7</b>	<b>Maintenance</b>	<b>17</b>
7.1	Cleaning	17
7.2	Disinfection / Decontamination	18
7.3	Decontamination before shipping	18
7.4	Temperature control	18

## Table of contents





<b>8</b>	<b>Transport, storage and disposal</b> .....	<b>19</b>
8.1	Transport .....	19
8.2	Storage .....	19
8.3	Disposal .....	19
<b>9</b>	<b>Technical data</b> .....	<b>20</b>
9.1	Power supply .....	20
9.2	Ambient conditions .....	20
9.3	Weight / dimensions .....	20
9.4	Application parameters .....	20
<b>10</b>	<b>Ordering information</b> .....	<b>21</b>
10.1	Thermomixer compact .....	21
10.2	Tubes .....	21
10.3	IsoTherm-System .....	22
10.4	Temperature sensor .....	22
<b>11</b>	<b>Index</b> .....	<b>23</b>

## 1 User instructions

### 1.1 Using this manual

- ▶ Before using the device for the first time, please read the operating manual.
- ▶ Please view this operating manual as part of the product and keep it somewhere easily accessible.
- ▶ If the device is transferred to a third party, include this operating manual.

### 1.2 Warning signs and hazard icons

Depiction	Meaning
	<b>DANGER</b> Risk of electric shock with potential for severe injury or death as a consequence.
	<b>DANGER</b> Risk of explosion with potential for severe injury or death as a consequence.
	<b>WARNING</b> Warning of potential injury or health risk.
	<b>CAUTION</b> Refers to risk of damage to property.
	Refers to particularly useful information and tips.

### 1.3 Symbols used

Depiction	Meaning
▶	You are requested to perform an action.
1. 2.	Perform these actions in the sequence described.
•	List.
<b>Text</b>	Terms from the device display.

### 1.4 Abbreviations used

**rpm** Revolutions per minute

## 2 Product description

### 2.1 Main illustration

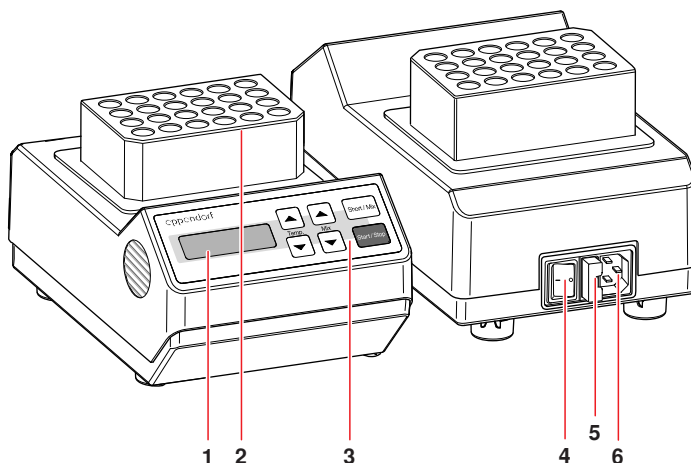

Fig. 1: Thermomixer compact / Thermomixer

<b>1 Display</b>	<b>2 Thermoblock</b>
<b>3 Control element</b>	<b>4 Mains switch</b>
<b>5 Fuse compartment</b>	<b>6 Mains connection socket</b>

### 2.2 Delivery package

Quantity	Order No. (International)	Order No. (North America)	Description
1	5350 000.013	022670051	<b>Thermomixer compact</b> with thermoblock for 1.5 mL test tubes, IsoRack and 0 °C IsoPack
or	-	022670000	<b>Thermomixer</b> with thermoblock for 1.5 mL test tubes, IsoRack and 0 °C IsoPack with US-plug
1	-	-	<b>Mains cable</b>
1	5350 900.014	-	<b>Operating Manual Thermomixer compact</b>

## 2 Product description

### 2.3 Features

#### 2.3.1 Thermomixer compact

The Thermomixer compact enables the temperature control and mixing of liquids in 1.5 ml micro test tubes (e.g. Eppendorf Safe-Lock).

Temperatures between 4 °C above room temperature and 99 °C are maintained accurately and constantly. You can set the mixing frequencies between 300 and 1,400 rpm. With the IsoRack, a total of 24 micro test tubes can be placed in a thermoblock. With the Eppendorf IsoRack, 24 micro test tubes at a time can be placed on a thermoblock. The IsoRack is part of the IsoTherm system. This means that with the Thermomixer compact and the IsoTherm system, micro test tubes can be handled on the lab bench at all the temperatures that are relevant for everyday lab use.

The robust, space-saving design of the Thermomixer compact combined with the chemical-resistant plastic housing and the keypad make this Eppendorf device another professional companion in your daily routine.

#### 2.3.2 IsoTherm system (optional accessory)

With the IsoTherm System you can cool samples efficiently and at a constant temperature for several hours and then thaw them gently.

In addition, the tube holder serves as a working aid during the filling of micro test tubes and the preparation, sorting, distribution, transporting, storing and freezing of samples in micro test tubes.

The IsoTherm system includes the components IsoRack, IsoPack and IsoSafe (optional accessories).

##### Features

- IsoPack and IsoSafe

Cooling batteries for -21 °C and 0 °C which allow temperature-sensitive samples to be stored for hours on the lab bench in a corresponding insulated box (IsoSafe).

- IsoRack

Tube holder for 24 micro test tubes 0.5 ml or 1.5/2.0 ml each to transfer the tubes from the cooling battery to the exchangeable thermoblocks. The stackable, snap-together racks for which a lid is available are also particularly suited to the storage of micro test tubes in fridges or freezers. The racks are autoclavable, the distance between the tubes in the rack permits the use of multi-channel pipettes.

---

**i** Further details can be found on our homepage [www.eppendorf.com](http://www.eppendorf.com) and in the operating manual for the IsoTherm system.

---

## 3 Safety

### 3.1 Intended use

The Thermomixer compact is intended exclusively for indoor use and is used for temperature control and mixing of aqueous solutions in micro test tubes.

Only use Eppendorf accessories or accessories recommended by Eppendorf.

### 3.2 User profile

This device must only be used by skilled personnel with the appropriate training.

Before using the device, read the operating manual carefully and familiarize yourself with the device's mode of operation.

### 3.3 Note on product liability

In the following cases the protection provided in the device may be impaired. The liability for the function of the device passes to the operator if:

- The device is not used in accordance with the operating manual.
- The device is used outside the range of application described herein.
- The device is used with accessories or consumables (e.g. tubes) which are not recommended by Eppendorf.
- The device is maintained or repaired by persons not authorized by Eppendorf.
- The owner has made unauthorized modifications to the device.

### 3.4 Warnings for intended use

Please read the operating manual and note the following general safety instructions before using the Thermomixer compact.



#### **Risk of explosion!**

- ▶ Do not operate the device in rooms where work is being carried out with explosive substances.
- ▶ Do not use this device to process any explosive or highly reactive substances.
- ▶ Do not use this device to process any substances which could create an explosive atmosphere.



#### **Danger! Electric shock from damage to device/power cable.**

- ▶ Only switch on the device if the device and the power cable are undamaged.
- ▶ Only use devices that have been properly installed or repaired.



#### **Danger! Lethal voltages inside the device.**

- ▶ Ensure that the housing is always closed and undamaged so that no parts inside the device can be contacted by accident.
- ▶ Do not remove the housing of the device.
- ▶ Do not allow the device to be opened by anyone except service personnel who have been specifically authorized by Eppendorf.



### 3 Safety



#### **Danger! Electric shock as a result of penetration of liquid.**

- ▶ Switch off the device and disconnect it from the power supply before starting cleaning or disinfecting.
- ▶ Do not allow any liquids to enter the inside of the housing.
- ▶ Do not perform spray disinfection.
- ▶ Only reconnect the device to the power supply once it is completely dry.



#### **Danger! Damage to health from biologically or chemically hazardous substances.**

Hazardous chemicals cause burns and other health hazards.

- ▶ Observe the material safety data sheets for the biological and chemical substances used.
- ▶ Wear personal protective equipment (PPE) at all times when working with biological or chemical substances.
- ▶ Follow the instructions for cleaning and decontamination, and ensure that hygiene safety standards are maintained.



#### **Risk when handling toxic or radioactively-marked liquids or pathogenic germs.**

- ▶ Follow national regulations governing the handling of these substances.
- ▶ For complete instructions regarding the handling of germs or biological material of risk group II or higher, please refer to the "Laboratory Biosafety Manual" (Source: World Health Organization, current edition of the Laboratory Biosafety Manual).



#### **Warning! Damage due to incorrect power supply.**

- ▶ Only connect the device to power sources that match the electrical specifications on the device's nameplate.
- ▶ Use only sockets with protective earth.



#### **Warning! Risk of burns from hot surfaces.**

The exchangeable thermoblock can be very hot after heating and cause burns.

- ▶ Avoid direct contact with a heated thermoblock.



#### **Warning! Risk of injury through chemical or mechanical damage to exchangeable thermoblocks.**

- ▶ Check the exchangeable thermoblocks regularly.
- ▶ Do not use exchangeable thermoblocks that show signs of corrosion or mechanical damage.



#### **Warning! Poor safety due to incorrect accessories and spare parts.**

The use of accessories and spare parts other than those recommended by Eppendorf may impair the safety, function and precision of the device. Eppendorf accepts no warranty or liability for damage caused by non-recommended accessories and spare parts or incorrect use.

- ▶ Use only accessories recommended by Eppendorf and original spare parts.

### 3 Safety

**Warning! Risk to health from contaminated device**

- ▶ Perform decontamination before storing or dispatching the device and/or its accessories.

**Warning! Contamination due to opening tube lids.**

In the following cases, the lids of PCR tubes can spring open and the sample material can escape:

- high vapor pressure of the content
  - improperly sealed lid
  - damaged sealing lip
- ▶ Always check that micro test tubes have been sealed tightly before use.

**Caution! Strong vibration.**

At high speeds items near the device can be moved by vibrations of the work surface and may e.g. fall off the work table.

- ▶ Do not place easily movable items near the mixer or secure them adequately.

**Caution! Damage to the display due to mechanical pressure.**

- ▶ Do not exert mechanical pressure on the display.

**Caution! Damage to electronic components from condensation.**

- ▶ After moving the device from a cooler environment (e.g: cool room or outdoors), wait at least an hour before connecting it to the mains power supply.

**Caution when using aggressive chemicals.**

Aggressive chemicals may damage both the device and its accessories.

- ▶ Do not use any aggressive chemicals on the device and accessories such as strong or weak bases, strong acids, acetone, formaldehyde, halogenated hydrocarbons or phenol.
- ▶ If the device becomes contaminated with aggressive chemicals, clean it immediately with a neutral cleaning agent.

**Caution! Lack of safety due to missing operating manual.**

- ▶ When passing on the device, always enclose the operating manual.
- ▶ If you lose the operating manual, request a replacement. The current version of the operating manual and the safety instructions can also be found on our website [www.eppendorf.com](http://www.eppendorf.com).

## 4 Installation

### 4.1 Preparing installation

- 
- i** Retain the transport carton and the packing material for subsequent safe transport or storage.

- 
- ▶ Use the details in the delivery package to check that the delivery is complete.
  - ▶ Check all parts for any transport damage.

### 4.2 Selecting location

Select a location for the Thermomixer compact in accordance with the following criteria:

- Mains power connection (230 V/120 V) as per device identification plate. This is located on the rear side of the device.
- At least 10 cm away from adjacent devices and walls.
- Solid bench with stable, horizontal and even work surface.

### 4.3 Installing instrument

1. Place the Thermomixer compact on a suitable surface so that the ventilation slots on the base of the device are not blocked.

- 
- i** Only operate the Thermomixer compact in a mains network with protective ground.

- 
2. Connect the provided mains cable to the mains connection socket of the Thermomixer compact and to the power supply.
  3. Switch on the Thermomixer compact at the mains power switch.
  4. Perform a test run at maximum speed (1.400 rpm) to make sure the the adhesion between device and surface is sufficient. The Thermomixer compact must not move.

## 5 Operation

### 5.1 Overview of operating controls

Before using the Thermomixer compact for the first time, familiarize yourself with the operating controls and the display.

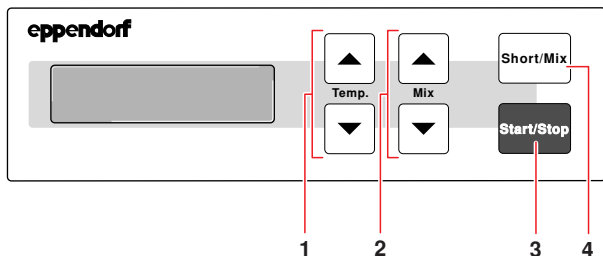

Fig. 2: Operator control elements and display

<b>1</b> Setting the temperature	<b>2</b> Setting the mixing frequency
<b>3</b> Starting or stopping a run	<b>4</b> Starting shortmix

- i** After switching on, the display shows the values of the last run.

### 5.2 Inserting tubes

- ▶ Press the tubes lightly into the holders of the thermoblocks.

To maximize temperature control, transfer the micro test tubes in IsoRacks to the thermoblock. The IsoRack reduces the heat exchange of the thermoblock with the environment. However, the cover of the IsoRack does not need to be closed for this purpose.

## 5 Operation

### 5.3 Temperature control and mixing

After switching on, the display shows the last values used before switching off. The actual temperature flashes.

#### 5.3.1 Tempering

The lowest adjustable value is 4 °C above room temperature.

- ▶ Set the temperature using the "Temp." arrow keys.

On the display, the nominal temperature is displayed on the left, the actual temperature on the right. The temperature between 1 °C and 99 °C is then adjusted immediately. When the nominal value is reached, only this value will be displayed.

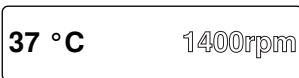

The temperature can be adjusted gradually by pressing the key briefly or continuously by pressing the key continuously.

You can also change the nominal temperature while the device is running. The run will be continued with the re-set nominal temperature.

#### 5.3.2 Operation without temperature control

- ▶ Press the "Temp." arrow key until **off** appears on the display.  
The device remains at room temperature and does not heat.

#### 5.3.3 Mixing

The mixing frequency (-- rpm) is displayed on the right of the display next to the temperature.

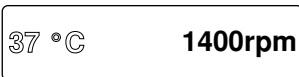

1. Set the mixing frequency with the "Mix" arrow keys.  
You can adjust the mixing frequency to between 300 and 1,400 rpm.
2. Press the "Start/Stop" key to start the mixing process.
3. To finish the mixing process, press "Start/Stop" again.

#### 5.3.4 Short Mix

- ▶ Keep the "Short Mix" key pressed.  
The device mixes with the set frequency until the "Short Mix" key is released.

#### 5.3.5 Save the values

The set values will be saved even after the device has been switched off.

## 6 Troubleshooting

### 6.1 General errors

- i** If the proposed measures to remedy the fault repeatedly do not deliver the desired result, contact your local Eppendorf partner. The addresses of our dealers are available on our website [www.eppendorf.com](http://www.eppendorf.com), the addresses of our sales offices are on the penultimate page of this operating manual.

Symptom / message	Cause	Remedy
Display remains dark.	<ul style="list-style-type: none"> <li>No mains connection.</li> <li>Device fuse defective.</li> </ul>	<ul style="list-style-type: none"> <li>▶ Check the mains connection and the power supply.</li> <li>▶ Switch the device on.</li> </ul>
Nominal temperature is not reached.	At nominal values over 4 °C above room temperature.	<ul style="list-style-type: none"> <li>▶ Set up the device in a cooler environment.</li> </ul>
The device does not mix or control the temperature.	Various causes are possible.	<ul style="list-style-type: none"> <li>▶ Contact your local Eppendorf partner.</li> </ul>

### 6.2 Error messages

Symptom / message	Cause	Remedy
<b>MOTOR ERR</b>	Motor is not turning.	<ol style="list-style-type: none"> <li>1. Switch device off and wait for 10 seconds.</li> <li>2. Switch the device on.</li> </ol>
<b>SPEED ERR</b>	Motor is turning at overspeed.	<ol style="list-style-type: none"> <li>1. Switch device off and wait for 10 seconds.</li> <li>2. Switch the device on.</li> </ol>
<b>TOO HOT!</b>	Thermoblock hotter than 110 °C.	<ol style="list-style-type: none"> <li>1. Switch device off and wait for 10 seconds.</li> <li>2. Switch the device on.</li> </ol>
<b>T-SENSOR ERR</b>	Temperature sensor error.	<ol style="list-style-type: none"> <li>1. Switch device off and wait for 10 seconds.</li> <li>2. Switch the device on.</li> </ol>
<b>TEMP ERR!</b>	Nominal temperature is not reached.	<ol style="list-style-type: none"> <li>1. Switch the device off and wait for 10 seconds.</li> <li>2. Switch the device on.</li> </ol>
<b>EEChksumERR</b> <b>RAM ERR</b> <b>EEprom ERR</b>	Memory error	<ol style="list-style-type: none"> <li>1. Switch the device off and wait for 10 seconds.</li> <li>2. Switch the device on.</li> </ol>
<b>HEAVY LOAD</b>	The motor does not reach nominal speed.	<ul style="list-style-type: none"> <li>▶ Check if the movement of the exchangeable thermoblock is obstructed (e.g. by jammed object).</li> </ul>

## 7 Maintenance

### 7.1 Cleaning

Regularly clean the housing of the Thermomixer compact and the exchangeable thermoblocks.



#### **Danger! Electric shock as a result of penetration of liquid.**

- ▶ Switch off the device and disconnect it from the power supply before starting cleaning or disinfecting.
- ▶ Do not allow any liquids to enter the inside of the housing.
- ▶ Do not perform spray disinfection.
- ▶ Only reconnect the device to the power supply once it is completely dry.

#### **Caution when using aggressive chemicals.**

Aggressive chemicals may damage both the device and its accessories.

- ▶ Do not use any aggressive chemicals on the device and accessories such as strong or weak bases, strong acids, acetone, formaldehyde, halogenated hydrocarbons or phenol.
- ▶ If the device becomes contaminated with aggressive chemicals, clean it immediately with a neutral cleaning agent.

#### **Caution! Corrosion from aggressive cleaning agents and disinfectants.**

- ▶ Do not use corrosive cleaning agents, aggressive solvents or abrasive polishes.

#### **Auxiliary aids**

- Lint free cloth
- Mild, soap-based household cleaning agent
- Dist. water

#### **Cleaning the Thermomixer compact**

1. Switch the Thermomixer compact off and isolate from the power supply.
2. Clean all of the outer parts of the Thermomixer compact with a mild, soap-based solution and a lint-free cloth.
3. Wipe off the soap solution with dist. water.
4. Dry all cleaned parts.

#### **Cleaning thermoblocks**

- ▶ Remove any contamination with a damp, lint-free cloth. Use a mild lab cleaner if necessary.

## 7 Maintenance

### 7.2 Disinfection / Decontamination



#### **Danger! Electric shock as a result of penetration of liquid.**

- ▶ Switch off the device and disconnect it from the power supply before starting cleaning or disinfecting.
- ▶ Do not allow any liquids to enter the inside of the housing.
- ▶ Do not perform spray disinfection.
- ▶ Only reconnect the device to the power supply once it is completely dry.

#### **Auxiliary equipment**

- lint-free cloth,
  - disinfectant.
1. Switch the Thermomixer compact off and isolate from the power supply.
  2. Allow the device to cool down.
  3. Clean the device (see *Cleaning* on page 17).
  4. Select a disinfection method which complies with the legal requirements and regulations applicable to your range of application.
  5. Wipe the surfaces with the lint-free cloth and disinfectant.

### 7.3 Decontamination before shipping

If you are shipping the device to the authorized Technical Service for repairs or to your authorized dealer for disposal please note the following:



#### **Warning! Risk to health from contaminated device**

1. Follow the instructions in the decontamination certificate. It is available in PDF format on our homepage ([www.eppendorf.com/decontamination](http://www.eppendorf.com/decontamination)).
2. Decontaminate all the parts you want to dispatch.
3. Enclose the fully-completed decontamination certificate for returned goods (incl. the serial number of the device) with the dispatch.

### 7.4 Temperature control

The application parameters in the technical data (see p. 20) define the limits and deviations (tolerances) on all positions of a thermoblock / exchangeable thermoblock.

Use the temperature validation system for an exact control of the temperatures. For the 1.5 ml reference exchangeable thermoblock there is a temperature sensor - 1.5 mL for all Thermomixer and ThermoState from Eppendorf which can measure the exact temperature in the block (see *Temperature sensor* on page 22).



## 8 Transport, storage and disposal

### 8.1 Transport

- ▶ Only transport the device in the original packaging.

	Air temperature	Rel. humidity	Air pressure
General transportation	-20 to 60 °C	10 to 95 %	30 to 106 kPa
Air freight	-20 to 55 °C	10 to 95 %	30 to 106 kPa

### 8.2 Storage

	Air temperature	Rel. humidity	Air pressure
In transport packaging	-25 to 55 °C	10 to 95%	70 to 106 kPa
Without transport packaging	-5 to 45 °C	10 to 95%	70 to 106 kPa

### 8.3 Disposal

In the event of disposing of the product, please observe the applicable legal regulations.

#### Information on the disposal of electrical and electronic devices in the European Community:

The disposal of electrical devices is regulated within the European Community by national regulations based on EU Directive 2002/96/EC pertaining to waste electrical and electronic equipment (WEEE).

In accordance with this, any devices delivered after 13/08/2005 on a business-to-business basis, which includes this product, may no longer be disposed of in household waste. To document this they have been marked with the following identification:



Because disposal regulations may differ from one country to another within the EU please contact your supplier if necessary.

## 9 Technical data

### 9.1 Power supply

Mains connection:	100 to 240 V $\pm$ 10 %, 50 to 60 Hz
Fuses:	see nameplate or label on the rear of the device
Power consumption:	90W

### 9.2 Ambient conditions

Environment:	For indoor use only
Ambient temperature:	4 to 35 °C
Relative humidity:	70 % max.

### 9.3 Weight / dimensions

Dimensions (W x D x H):	165 x 250 x 145 mm
Weight basic device:	2.4 kg

### 9.4 Application parameters

Temperature control range:	4 °C above room temperature up to 99 °C
Temperature control accuracy: <ul style="list-style-type: none"> <li>• at nominal values between 20 °C and 45 °C</li> <li>• at nominal values between &lt;20 °C and &gt;45 °C</li> </ul>	<ul style="list-style-type: none"> <li>• <math>\pm</math>1 °C</li> <li>• <math>\pm</math>2 °C</li> </ul>
Heating rate:	approx. 5 °C/min The temperature changes in the filled tubes are slower.
Mixing frequency:	300 to 1.400 1/min
Mixing stroke:	3 mm

## 10 Ordering information



### Warning! Poor safety due to incorrect accessories and spare parts.

The use of accessories and spare parts other than those recommended by Eppendorf may impair the safety, function and precision of the device. Eppendorf accepts no warranty or liability for damage caused by non-recommended accessories and spare parts or incorrect use.

- ▶ Use only accessories recommended by Eppendorf and original spare parts.

### 10.1 Thermomixer compact

Order No. (International)	Order No. (North America)	Description
5350 000.013	022670051	<b>Thermomixer compact</b> with thermoblock for 1.5 mL test tubes, IsoRack and 0 °C IsoPack
-	022670000	<b>Thermomixer</b> with thermoblock for 1.5 mL test tubes, IsoRack and 0 °C IsoPack with US-plug

### 10.2 Tubes

Order No. (International)	Order No. (North America)	Description
0030 120.086	-	<b>Safe-Lock micro test tubes</b> 1.5 mL per 1,000 pcs. colorless yellow red blue green assortment amber
0030 120.159	-	
0030 120.167	-	
0030 120.175	-	
0030 120.183	-	
0030 121.694	-	
0030 120.191	-	
-	022363204	
-	022363301	
-	022363280	
-	022363247	
-	022363263	
-	022363328	
-	022363221	

## 10 Ordering information

### 10.3 IsoTherm-System

Order No. (International)	Order No. (North America)	Description
3880 001.018 3880 000.011	022510053 022510002	<b>IsoTherm System</b> includes IsoSafe, IsoRack, 0 °C IsoPack and -21 °C for 1.5 mL / 2.0 mL tubes 0.5 mL tubes
3881 000.015 3881 000.023 3881 000.031	022510509 022510541 022510525	<b>PCR-Cooler</b> Starter Set (1 x pink, 1 x blue) Pink Blue

### 10.4 Temperature sensor

Order No. (International)	Order No. (North America)	Description
0055 000.298	950008059	<b>Temperature validation system</b> for Mastercycler, Mastercycler ep and Mastercycler pro
5354 850.500	on request	<b>Temperature sensor - 1.5 mL</b>

Index

**A**

Ambient conditions ..... 20

Application parameter..... 20

**C**

Cleaning ..... 17, 17, 17

**D**

Decontamination..... 18

Dimensions ..... 20

Disposal ..... 19

**H**

Hazard icons ..... 7

Hazards ..... 10

**I**

Installation

    Device ..... 13

    Preparation..... 13

    Select location..... 13

Intended use

    Hazards ..... 10

**O**

Operating controls ..... 14

**P**

Power supply ..... 20

**S**

Safety instructions ..... 10

Safety notes

    Meaning of the symbols ..... 7

Select location ..... 13

Storage ..... 19

**T**

Technical data

    Ambient conditions ..... 20

    Application parameter ..... 20

    Dimensions ..... 20

    Power supply ..... 20

Temperature control ..... 18

Transport ..... 19

**W**

Warning signs

    Instructions ..... 7

Weight

    Device ..... 20

# EG-Konformitätserklärung EC Conformity Declaration

Das bezeichnete Produkt entspricht den einschlägigen grundlegenden Anforderungen der aufgeführten EG-Richtlinien und Normen. Bei einer nicht mit uns abgestimmten Änderung des Produktes oder einer nicht bestimmungsgemäßen Anwendung verliert diese Erklärung ihre Gültigkeit.

The product named below fulfills the relevant fundamental requirements of the EC directives and standards listed. In the case of unauthorized modifications to the product or an unintended use this declaration becomes invalid.

Produktbezeichnung, Product name:

Thermomixer compact 5350

Produkttyp, Product type:

Thermomixer für Reaktionsgefäße / Thermomixer for micro test tubes

Einschlägige EG-Richtlinien/Normen, Relevant EC directives/standards:

2006/95/EG, EN 61010-1, EN 61010-2-10/A1, EN 61010-2-051

2004/108/EG, EN 55011/B, EN 61000-6-1, EN 61000-3-2, EN 61000-4-14

  
\_\_\_\_\_  
Vorstand, Board of Management:

05.11.2009

Hamburg, Date:

  
\_\_\_\_\_  
Projektmanagement, Project Management:

**eppendorf**

Eppendorf AG · Barkhausenweg 1 · 22339 Hamburg · Germany



## Eppendorf offices

### AUSTRALIA & NEW ZEALAND

Eppendorf South Pacific Pty. Ltd.  
Telefon: +61 2 9889 5000  
Fax: +61 2 9889 5111  
E-Mail: [Info@eppendorf.com.au](mailto:Info@eppendorf.com.au)  
Internet: [www.eppendorf.com.au](http://www.eppendorf.com.au)

### AUSTRIA

Eppendorf Austria GmbH  
Telefon: +43 (0) 1 890 13 64 - 0  
Fax: +43 (0) 1 890 13 64 - 20  
E-Mail: [office@eppendorf.at](mailto:office@eppendorf.at)  
Internet: [www.eppendorf.at](http://www.eppendorf.at)

### BRAZIL

Eppendorf do Brasil Ltda.  
Telefon: +55 11 30 95 93 44  
Fax: +55 11 30 95 93 40  
E-Mail: [eppendorf@eppendorf.com.br](mailto:eppendorf@eppendorf.com.br)  
Internet: [www.eppendorf.com.br](http://www.eppendorf.com.br)

### CANADA

Eppendorf Canada Ltd.  
Telefon: +1 905 826 5525  
Fax: +1 905 826 5424  
E-Mail: [canada@eppendorf.com](mailto:canada@eppendorf.com)  
Internet: [www.eppendorfn.com](http://www.eppendorfn.com)

### CHINA

Eppendorf China Ltd.  
Telefon: +86 21 38560500  
Fax: +86 21 38560555  
E-Mail: [market.info@eppendorf.cn](mailto:market.info@eppendorf.cn)  
Internet: [www.eppendorf.cn](http://www.eppendorf.cn)

### CZECH REP. & SLOVAKIA

Eppendorf Czech & Slovakia s.r.o.  
Telefon: +420 323 605 454  
Fax: +420 323 605 454  
E-Mail: [eppendorf@eppendorf.cz](mailto:eppendorf@eppendorf.cz)  
Internet: [www.eppendorf.cz](http://www.eppendorf.cz) /  
[www.eppendorf.sk](http://www.eppendorf.sk)

### FRANCE

Eppendorf France S.A.R.L.  
Telefon: +33 1 30 15 67 40  
Fax: +33 1 30 15 67 45  
E-Mail: [eppendorf@eppendorf.fr](mailto:eppendorf@eppendorf.fr)  
Internet: [www.eppendorf.fr](http://www.eppendorf.fr)

### GERMANY

Eppendorf Vertrieb  
Deutschland GmbH  
Telefon: +49 2232 418-0  
Fax: +49 2232 418-155  
E-Mail: [vertrieb@eppendorf.de](mailto:vertrieb@eppendorf.de)  
Internet: [www.eppendorf.de](http://www.eppendorf.de)

### INDIA

Eppendorf India Limited  
Telefon: +91 44 42 11 13 14  
Fax: +91 44 42 18 74 05  
E-Mail: [info@eppendorf.co.in](mailto:info@eppendorf.co.in)  
Internet: [www.eppendorf.co.in](http://www.eppendorf.co.in)

### ITALY

Eppendorf s.r.l.  
Telefon: +390 2 55 404 1  
Fax: +390 2 58 013 438  
E-Mail: [eppendorf@eppendorf.it](mailto:eppendorf@eppendorf.it)  
Internet: [www.eppendorf.it](http://www.eppendorf.it)

### JAPAN

Eppendorf Co. Ltd.  
Telefon: +81 3 5825 2363  
Fax: +81 3 5825 2365  
E-Mail: [info@eppendorf.jp](mailto:info@eppendorf.jp)  
Internet: [www.eppendorf.jp](http://www.eppendorf.jp)

### NORDIC

Eppendorf Nordic Aps  
Telefon: +45 70 22 2970  
Fax: +45 45 76 7370  
E-Mail: [nordic@eppendorf.dk](mailto:nordic@eppendorf.dk)  
Internet: [www.eppendorf.dk](http://www.eppendorf.dk)

### SOUTH & SOUTHEAST ASIA

Eppendorf Asia Pacific Sdn. Bhd.  
Telefon: +60 3 8023 2769  
Fax: +60 3 8023 3720  
E-Mail: [eppendorf@eppendorf.com.my](mailto:eppendorf@eppendorf.com.my)  
Internet: [www.eppendorf.com.my](http://www.eppendorf.com.my)

### SPAIN

Eppendorf Ibérica S.L.U.  
Telefon: +34 91 651 76 94  
Fax: +34 91 651 81 44  
E-Mail: [iberica@eppendorf.es](mailto:iberica@eppendorf.es)  
Internet: [www.eppendorf.es](http://www.eppendorf.es)

### SWITZERLAND

Vaudaux-Eppendorf AG  
Telefon: +41 61 482 1414  
Fax: +41 61 482 1419  
E-Mail: [vaudaux@vaudaux.ch](mailto:vaudaux@vaudaux.ch)  
Internet: [www.eppendorf.ch](http://www.eppendorf.ch)

### UNITED KINGDOM

Eppendorf UK Limited  
Telefon: +44 1223 200 440  
Fax: +44 1223 200 441  
E-Mail: [sales@eppendorf.co.uk](mailto:sales@eppendorf.co.uk)  
Internet: [www.eppendorf.co.uk](http://www.eppendorf.co.uk)

### USA

Eppendorf North America, Inc.  
Telefon: +1 516 334 7500  
Fax: +1 516 334 7506  
E-Mail: [info@eppendorf.com](mailto:info@eppendorf.com)  
Internet: [www.eppendorfn.com](http://www.eppendorfn.com)

### OTHER COUNTRIES

Internet: [www.eppendorf.com/worldwide](http://www.eppendorf.com/worldwide)



## Evaluate your operating manual

[www.eppendorf.com/manualfeedback](http://www.eppendorf.com/manualfeedback)

# eppendorf

*In touch with life*

**Your local distributor: [www.eppendorf.com/worldwide](http://www.eppendorf.com/worldwide)**

Eppendorf AG · 22331 Hamburg · Germany · Tel: +49 40 538 01-0 · Fax: +49 40 538 01-556

E-Mail: [eppendorf@eppendorf.com](mailto:eppendorf@eppendorf.com)

Eppendorf North America, Inc. · 102 Motor Parkway, Suite 410 · Hauppauge, NY 11788-5178 · USA

Tel: +1 516 334 7500 · Toll free phone: +1 800 645 3050 · Fax: +1 516 334 7506 · E-Mail: [info@eppendorf.com](mailto:info@eppendorf.com)

### **Application Support**

Europe, International: Tel: +49 1803 666 789 · E-Mail: [support@eppendorf.com](mailto:support@eppendorf.com)

North America: Tel: +1 800 645 3050 ext. 2258 · E-Mail: [techserv@eppendorf.com](mailto:techserv@eppendorf.com)

Asia Pacific: Tel: +60 3 8023 6869 · E-Mail: [support\\_asiapacific@eppendorf.com](mailto:support_asiapacific@eppendorf.com)