

Register your instrument!
www.eppendorf.com/myeppendorf



Eppendorf ThermoStat C

Operating manual

Copyright ©2019 Eppendorf AG, Germany. All rights reserved, including graphics and images. No part of this publication may be reproduced without the prior permission of the copyright owner.

Eppendorf® and the Eppendorf Brand Design are registered trademarks of Eppendorf AG, Germany.

Eppendorf ThermoMixer®, Eppendorf ThermoTop®, and *condens.protect*® are registered trademarks of Eppendorf AG, Germany.

Eppendorf ThermoStat™ and Eppendorf SmartBlock™ are trademarks of Eppendorf AG, Germany.

Registered trademarks and protected trademarks are not marked in all cases with ® or ™ in this manual.

Table of contents

1	Operating instructions	5
1.1	Using this manual	5
1.2	Danger symbols and danger levels	5
1.2.1	Danger symbols	5
1.2.2	Danger levels	5
1.3	Symbols used	6
2	Safety	7
2.1	Intended use	7
2.2	User profile	7
2.3	Information on product liability	7
2.4	Warnings for intended use	8
2.5	Danger symbols on the device	9
3	Product description	10
3.1	Delivery package	10
3.2	Product overview	10
3.3	Features	11
4	Installation	12
4.1	Selecting the location	12
4.2	Installing the instrument	12
5	Operation	13
5.1	Operating controls	13
5.2	Setting the language	15
5.3	Installing the thermoblock	16
5.3.1	Attaching the thermoblock	16
5.3.2	Removing the thermoblock	17
5.4	Inserting tubes and plates	17
5.4.1	Inserting tubes	17
5.4.2	Inserting the plate	17
5.5	Controlling the thermoblock temperature	18
5.5.1	Temperature control with time setting	19
5.5.2	Temperature control with continuous run	19
5.5.3	Interrupt time counting	20
5.5.4	Temperature control with Temp Control or Time Control	20
5.6	Navigating the menu	21
5.7	Menu structure	22
5.7.1	Overview	22
5.7.2	Key lock	23

4 Table of contents
Eppendorf ThermoStat C
English (EN)

5.8	Programs	24
5.8.1	Creating a program	24
5.8.2	Restricting ramp rates	26
5.8.3	Loading a saved program	26
5.8.4	Editing programs	27
5.8.5	Deleting programs	28
6	Troubleshooting	29
6.1	General errors	29
6.2	Error messages	30
7	Maintenance	31
7.1	Setting service intervals	31
7.2	Cleaning	31
7.2.1	Cleaning the Eppendorf ThermoStat C	32
7.3	Disinfection/decontamination	32
7.4	Decontamination before shipment	33
7.5	Verification of temperature control	33
8	Transport, storage and disposal	34
8.1	Transport	34
8.2	Storage	34
8.3	Disposal	35
9	Technical data	36
9.1	Power supply	36
9.2	Weight/dimensions	36
9.3	Ambient conditions	36
9.4	Application parameters	37
9.4.1	Temperature control	37
9.4.2	Time setting	37
9.5	Thermoblocks	38
9.6	Interface	38
10	Program data form	39
	Certificates	41

1 Operating instructions







1.1 Using this manual

- ▶ Read this operating manual completely before using the device for the first time. Observe the instructions for use of the accessories where applicable.
- ▶ This operating manual is part of the product. Please keep it in a place that is easily accessible.
- ▶ Enclose this operating manual when transferring the device to third parties.
- ▶ The current version of the operating manual for all available languages can be found on our webpage www.eppendorf.com/manuals.

1.2 Danger symbols and danger levels

1.2.1 Danger symbols

The safety instructions in this manual have the following danger symbols and danger levels:

	Hazard point		Biohazard
	Electric shock		Highly flammable substances
	Risk of crushing		Hot surface
	Material damage		

1.2.2 Danger levels

DANGER	<i>Will</i> lead to severe injuries or death.
WARNING	<i>May</i> lead to severe injuries or death.
CAUTION	May lead to light to moderate injuries.
NOTICE	May lead to material damage.

1.3 Symbols used

Depiction	Meaning
1. 2.	Actions in the specified order
▶	Actions without a specified order
•	List
<i>Text</i>	Display or software texts
	Additional information

2 Safety

2.1 Intended use

The Eppendorf ThermoStat C is designed for the temperature control of liquids in closed micro test tubes and closed plates for the preparation and processing of samples.

The product can be used for training, routine and research laboratories in the areas of life sciences, industry or chemistry. This product is intended to be used for research purposes only. Eppendorf does not provide a warranty for other applications. The product is not suitable for use in diagnostic or therapeutic applications.

2.2 User profile

The device and accessories may only be operated by trained and skilled personnel.

Before using the device, read the operating manual and the instructions for use of the accessories carefully and familiarize yourself with the device's mode of operation.

2.3 Information on product liability

In the following cases, the designated protection of the device may be affected. Liability for any resulting damage or personal injury is then transferred to the owner:

- The device is not used in accordance with the operating manual.
- The device is used outside of its intended use.
- The device is used with accessories or consumables that are not recommended by Eppendorf.
- The device is maintained or repaired by persons not authorized by Eppendorf AG.
- The user makes unauthorized changes to the device.

2.4 Warnings for intended use

Read the operating manual and observe the following general safety information before using the Eppendorf ThermoStat C.



WARNING! Electric shock due to damage to the device or mains/power cord.

- ▶ Only switch on the device if the device and mains/power cord are undamaged.
- ▶ Only operate devices which have been installed or repaired properly.
- ▶ In case of danger, disconnect the device from the mains/power supply voltage. Disconnect the mains/power plug from the device or the earth/grounded socket. Use the isolating device intended for this purpose (e.g. the emergency switch in the laboratory).



WARNING! Risk of burns from hot surfaces.

The thermoblock and the heating/cooling plate can be very hot after heating and cause burns.

- ▶ Allow the thermoblock and the heating/cooling plate to cool down completely before removing the thermoblock.



WARNING! Damage to health due to infectious liquids and pathogenic germs.

- ▶ When handling infectious liquids and pathogenic germs, observe the national regulations, the biosafety level of your laboratory, the material safety data sheets, and the manufacturer's application notes.
- ▶ Wear your personal protective equipment.
- ▶ For comprehensive regulations about handling germs or biological material of risk group II or higher, please refer to the "Laboratory Biosafety Manual" (source: World Health Organization, Laboratory Biosafety Manual, the current edition).



WARNING! Risk of fire.

- ▶ Do not use this device to process any highly flammable liquids.



WARNING! Contamination due to opening seals of consumables.

In the following cases, the seals of micro test tubes or plates can spring open. Sample material can escape.

- High vapor pressure of the content
 - Improperly sealed lid
 - Damaged sealing lip
 - Improperly fastened foil
- ▶ Always check that consumables have been sealed tightly before use.



CAUTION! Poor safety due to incorrect accessories and spare parts.

The use of accessories and spare parts other than those recommended by Eppendorf may impair the safety, functioning and precision of the device. Eppendorf cannot be held liable or accept any liability for damage resulting from the use of accessories and spare parts other than those recommended, or from the improper use of such equipment.

- ▶ Only use accessories and original spare parts recommended by Eppendorf.



NOTICE! Damage to the display due to mechanical pressure.

- ▶ Do not apply any mechanical pressure to the display.



NOTICE! Damage due to overheating.

- ▶ Do not install the device near heat sources (e.g. heating, drying cabinet).
- ▶ Do not expose the device to direct sunlight.
- ▶ Ensure unobstructed air circulation. Maintain a clearance of at least 10 cm around all ventilation gaps.

2.5 Danger symbols on the device

Representation	Meaning	Location
	Risk of burns from hot surfaces.	<ul style="list-style-type: none"> • Upper side of the device • On the thermoblock
	Hazard point ▶ Observe the operating manual.	Rear of the device

Product description

Eppendorf ThermoStat C
English (EN)

3 Product description**3.1 Delivery package**

Quantity	Description
1	Eppendorf ThermoStat C
1	Mains/power cord
1	Operating manual
1	Short instructions



- ▶ Check whether the delivery is complete.
- ▶ Check all parts for any transport damage.
- ▶ To safely transport and store the device, retain the transport box and packing material.

3.2 Product overview

Fig. 3-1: Eppendorf ThermoStat C

- | | |
|-------------------------|--|
| 1 Operating controls | 5 Mains/power switch |
| 2 Display | 6 Mains/power cord socket |
| 3 Heating/cooling plate | 7 USB interface (for Eppendorf Service only) |
| 4 Centering pins | |

3.3 Features

The Eppendorf ThermoStat C makes it possible to temperature control liquids effectively.

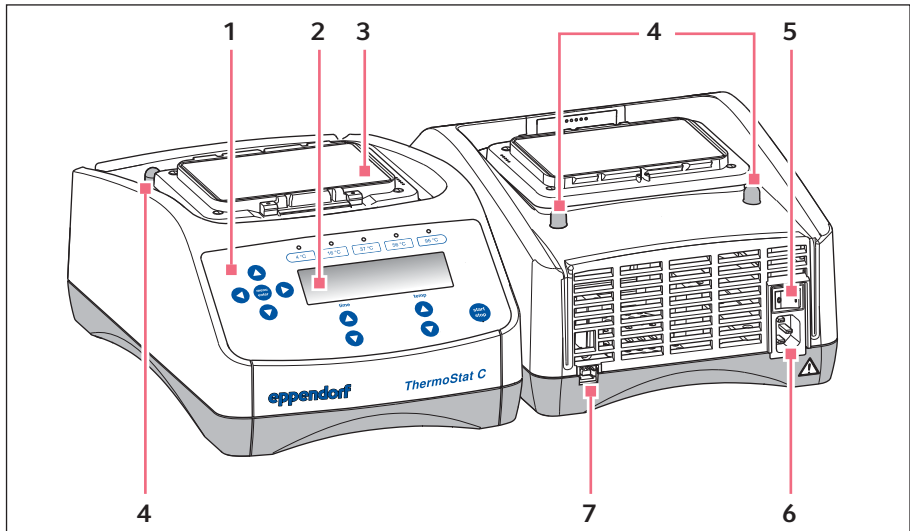
The thermoblocks can be exchanged quickly and easily, without the use of tools. The thermoblocks can be used with the following lab vessels:

- Micro test tubes with volumes of 0.2 mL to 5.0 mL
- Conical tubes with volumes of 15 mL to 50 mL
- Microplates and deepwell plates with any kind of bottom shape
- PCR plates in 96 and 384-well format
- Tubes with a diameter of 11.0 mm to 11.9 mm
- Cryogenic tubes

Temperature control

- **Interrupt time counting:** If you want to add reagents or exchange tubes during temperature control, you can interrupt time counting without interrupting the temperature control procedure.
- **Multi-level temperature control:** In addition to a simple temperature control run, you can freely program programs with up to four successive stages ("steps"). The temperature and duration of each level are freely selectable. The program levels automatically run one after the other.
- A total of 15 program slots is available.
- The 5 most common temperatures (4 °C, 16 °C, 37 °C, 56 °C, 95 °C) can be directly selected.

Lid and ThermoTop

- The Lid ensures uniform temperature control and protects samples from unwanted exposure to light.
- The ThermoTop prevents the formation of condensation on the inner wall or the lid of the tube thanks to the *condens.protect* technology.

SmartExtender

- The SmartExtender heats up lab vessels, independently from the SmartBlock, in a second temperature zone.

4 Installation

4.1 Selecting the location

Select the location of the device according to the following criteria:

- Mains/power connection in accordance with the name plate
 - Minimum distance to other devices and walls: 10 cm
 - Resonance free table with horizontal even work surface
 - The location must be well ventilated
 - The location is protected against direct sunlight
-  The mains/power switch and the disconnecting device of the mains/power line must be easily accessible during operation (e.g. a residual current circuit breaker).

4.2 Installing the instrument



WARNING! Danger due to incorrect voltage supply.

- ▶ Only connect the device to voltage sources which correspond with the electrical requirements on the name plate.
 - ▶ Only use earth/grounded sockets with a protective earth (PE) conductor.
 - ▶ Only use the mains/power cord supplied.
-

1. Place the Eppendorf ThermoStat C on a suitable work surface.
Position the device in such a way that the ventilation slots of the device are not obstructed.
2. Connect the power cable to the power connection socket of the device and the power supply.

5 Operation
5.1 Operating controls

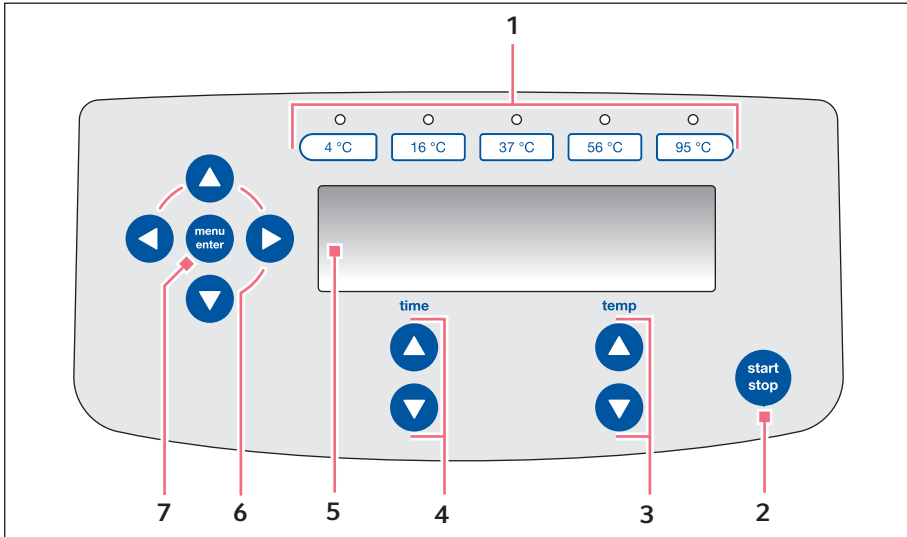

Fig. 5-1: Operating controls of Eppendorf ThermoStat C

- | | |
|--|--|
| 1 Temperature keys with control LEDs | 5 Display |
| 2 start/stop key
Press start/stop : start or stop temperature control | 6 Menu arrow keys
Navigate in the menu |
| 3 temp arrow keys
Set the temperature | 7 menu/enter key
Open the menu
Confirm your selection |
| 4 time arrow keys
Set the temperature control duration | |

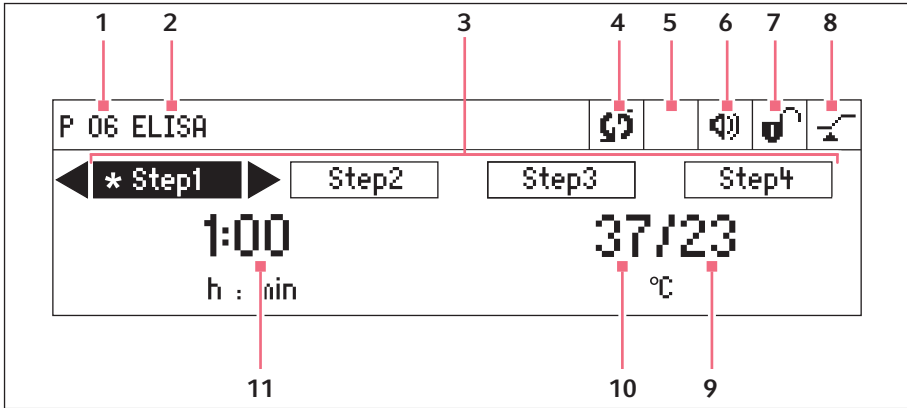



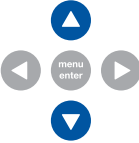



Fig. 5-2: Display of Eppendorf ThermoStat C

- | | |
|---|--|
| <p>1 Program number</p> <p>2 Program name</p> <p>3 Program levels (step 1 to step 4)
*: current step</p> <p>4 Device status
☺ Device in temperature control mode.
 Time counting interrupted.</p> <p>5 Accessories used
☒ ThermoTop has been attached.
☒ SmartExtender is attached.</p> <p>6 Speaker
☑ Speaker switched on.
☒ Speaker switched off.</p> | <p>7 Key lock
☒ Key lock is activated: parameters cannot be changed.
☑ No key lock.</p> <p>8 Time mode
☒ <i>Time Control</i> Time counting begins immediately.
☑ <i>Temp Control</i> Time counting begins when the set temperature has been reached.</p> <p>9 Actual temperature</p> <p>10 Set temperature
When the set temperature has been reached, only one value is displayed.</p> <p>11 Temperature control duration</p> |
|---|--|

5.2 Setting the language

The device is delivered with *English* as the default language. To set another language, proceed as follows:

1. Switch on the device with the power switch at the rear of the device.
2. To open the menu, press the **menu/enter** key.

3. Select the *Settings* menu item with the menu arrow key.

4. To confirm your selection, press the **menu/enter** key.

5. Select the *Language* menu item with the menu arrow keys. Confirm with the **menu/enter** key.

6. Select the language with the menu arrow keys and press the **menu/enter** key. A checkmark will appear in front of the selected language.

7. To exit the menu, press the left menu arrow key several times.

5.3 Installing the thermoblock



WARNING! Personal injury or material damage due to chemically or mechanically damaged thermoblocks.

- ▶ Do not use thermoblocks that show signs of corrosion or mechanical damage.
- ▶ Check the condition of the thermoblocks regularly.



NOTICE! Damage to electronic components due to condensation.

Condensate may form in the device when it has been transported from a cool environment to a warmer environment.

- ▶ After installing the device, wait for at least 3 h. Only then connect the device to the mains/power line.

When you attach the thermoblock, the device automatically recognizes the mounted thermoblock. The temperature is automatically limited to the maximum value for the thermoblock being used.



SmartBlock 12 mm and SmartBlock cryo: Temperature control possible up to 110 °C.

- ▶ Use only tubes that are suitable for temperature control up to 110 °C.

5.3.1 Attaching the thermoblock

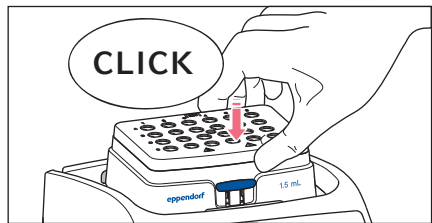
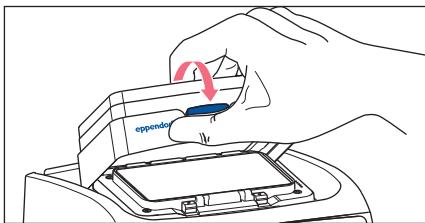

1. First only attach the rear edge of the thermoblock. The writing must face to the front.
2. Push the front edge of the thermoblock down.
 - The thermoblock audibly engages.
 - The display shows the name of the thermoblock.

5.3.2 Removing the thermoblock



WARNING! Risk of burns from hot surfaces.

The thermoblock and the heating/cooling plate can be very hot after heating and cause burns.

- ▶ Allow the thermoblock and the heating/cooling plate to cool down completely before removing the thermoblock.

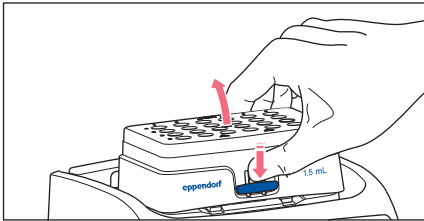

1. To unlock the thermoblock, press the lever at the front of the thermoblock down.
2. Lift the front edge so that the thermoblock is tilted backwards.
3. Remove the thermoblock upwards.

5.4 Inserting tubes and plates

5.4.1 Inserting tubes

- ▶ Only use closed tubes.
- ▶ Insert the tubes completely into the bores of the thermoblock.

5.4.2 Inserting the plate



The height sensor of the SmartBlock *plates* automatically differentiates between deepwell plates and microplates.

- ▶ When inserting microplates, make sure that the height sensor is not covered.
- ▶ Take care that the height sensor does not get contaminated.

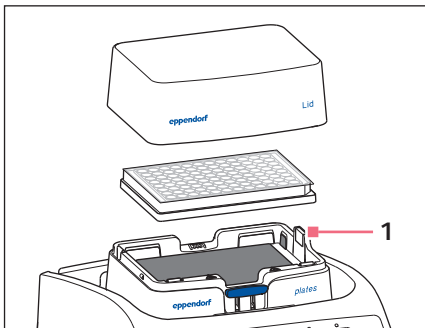

Fig. 5-3: 1 – SmartBlock plates height sensor

- ▶ Only use closed plates.
- ▶ Insert the plate with the back edge first. Then press it down at the front.
- ▶ To ensure uniform temperature control in all wells, place the lid on the thermoblock.

5.5 Controlling the thermoblock temperature



NOTICE! Damaged plates due to temperatures that are too high.

Polystyrene microplates melt at temperatures above 70 °C.

Polypropylene deepwell plates deform at temperatures above 80 °C. Deformed plates may become detached from the thermoblock or are more difficult to remove.

- ▶ Temper polystyrene microplates up to 70 °C max.



NOTICE! Material change of consumables at extreme temperatures.

Extreme temperatures (e.g. during refrigeration or autoclaving) affect the material. The mechanical strength, dimensions and shape of the consumable will change.

- ▶ Use consumables that are suitable for the selected temperature range or the selected procedure.

The Eppendorf ThermoStat C can control temperature in a range from 30 °C below ambient temperature to 110 °C.



- When the actual temperature flashes on the display, the device is not in temperature control mode operation.
- As soon as the set temperature is modified with the **temp** arrow keys, the device will start temperature control.
- When the set temperature has been reached, the display only shows a value.

5.5.1 Temperature control with time setting

Prerequisites

The time mode is set to *Time Control* (see p. 20)

1. Set the temperature control duration with the **time** arrow keys.
2. Set the temperature with the **temp** arrow keys.

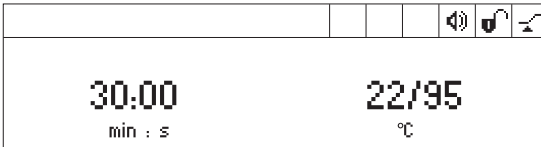

3. To start the time counter, press the **start/stop** key.
 - The  symbol flashes on the display.
 - The temperature control duration is counted down.
 - The display shows the remaining temperature control duration and the actual temperature/set temperature.
 - A signal sounds after the temperature control duration has elapsed.

5.5.2 Temperature control with continuous run



icing up of the thermoblock

Ice may form on the thermoblock if samples are tempered at low temperatures for a long time.

1. In order to temper without any time limits, use the **time** arrow keys to select the ∞ setting (▼ before 5 s or ▲ after 99:30 h).
2. Set the temperature with the **temp** arrow keys.

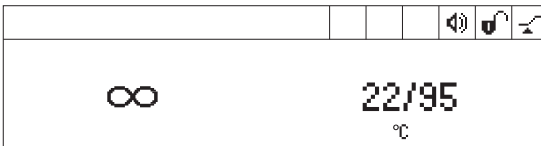

The device will immediately start temperature control.

3. To start the time counter, press the **start/stop** key.
 - The  symbol flashes on the display.
 - The temperature control duration is counted up.
 - The display alternately shows the temperature control duration and the ∞ symbol.
 - The actual and set temperatures are continuously displayed. The actual temperature slowly increases.

4. To end the temperature control procedure, press the **start/stop** key.

- A signal sounds.
- The display shows the last used parameters.

i In the continuous run mode, a temperature control duration of more than 99:30 h is possible. After 99:30 h has passed, the display will only show the ∞ symbol.

5.5.3 Interrupt time counting

If you want to add reagents or exchange tubes during temperature control, you can interrupt time counting without interrupting the temperature control procedure.

1. To interrupt the time counter, press and hold the **start/stop** key for 2 seconds.



- The display alternately shows the temperature control duration and *Pause*.
- Temperature control is continued.

2. To make the time counter continue, press the **start/stop** key.

5.5.4 Temperature control with *Temp Control* or *Time Control*

You can specify when time counting begins:

- Time counting begins immediately: *Time Control*
- Time counting begins when the set temperature has been reached: *Temp Control*

1. To open the menu, press the **menu/enter** key.

2. Use the menu arrow keys to select the *SmartBlock > Time mode* menu item.

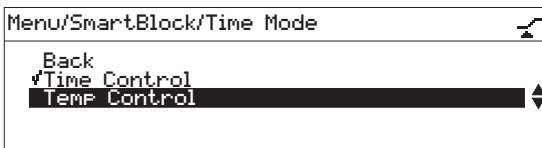

3. Use the menu arrow keys to select *Time Control* or *Temp Control*. Confirm with the **menu/enter** key.

A tick indicates the selected setting.

4. To exit the menu, press the left ◀ menu arrow key 3 times.

5.6 Navigating the menu

The menu has 3 levels. To change settings, proceed as follows:



1. To open the menu, press the **menu/enter** key.

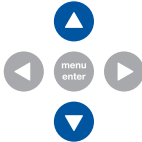

2. Select the menu item with the menu arrow keys.

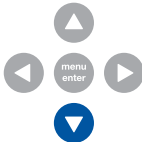

3. Activate the SmartExtender with the **down** menu arrow key (with the SmartExtender attached).



4. To confirm your selection, press the **menu/enter** key.

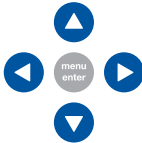

5. Change the settings with the menu arrow keys.







6. To confirm the changed setting, press the **menu/enter** key. A tick appears in front of the setting.

7. To exit the menu level, select *Back* in the menu and press the **menu/enter** key or press the left arrow key.



5.7 Menu structure

5.7.1 Overview

Menu level 1	Menu level 2	Menu level 3	Menu level 4
Back			
SmartBlock			
	Back		
	Programs		
		Back	
		P 01 --	
		...	
		P 15 --	
	Time mode		
		Back	
		Time Control 	
		Temp Control 	
SmartExtender (if it is attached)			
Key lock			
	Back		
	Key lock on 		
	Key lock off 		

Menu level 1	Menu level 2	Menu level 3	Menu level 4
Settings			
	Back		
	Signal tones		
		Back	
		Volume 	0%, 20%, 40%, 60%, 80%, 100%
		Repetitions	1 x, 5 x, 10 x, 30 x, unlimited
	Contrast		
		Back	
		Contrast	
			0%, 25%, 50%, 75%, 100%
	Language		
		Back	
		English	
		German	
		French	
		Italian	
		Spanish	
	Service		
		Back	
		No notification	
		After 500 operating hours	
	After 1000 operating hours		
	After 2000 operating hours		

5.7.2 Key lock

Menu items and options	Description	Symbol on the display
<ul style="list-style-type: none"> Key lock on 	<ul style="list-style-type: none"> Parameters cannot be changed. 	
<ul style="list-style-type: none"> Key lock off 	<ul style="list-style-type: none"> Parameters can be changed. 	

Operation

Eppendorf ThermoStat C
English (EN)

5.8 Programs

A program consists of up to four program levels ("steps"). The program levels automatically run one after the other. You can save separate settings for each program level:

- Temperature control duration
- Temperature
- Program levels with restricted ramp rates.

The program ends automatically.



The Eppendorf ThermoStat C has 15 program slots.

At the end of this operating manual there is a printed form of a program table. The program data can be noted there.

5.8.1 Creating a program

1. To open the menu, press the **menu/enter** key.
2. Use the menu arrow keys to select the *SmartBlock* > *Programs* menu item. Confirm with the **menu/enter** key.
3. Use the menu arrow keys to select an empty program slot. Confirm with the **menu/enter** key.

P 06		
Cancel	◀ Save ▶	Options
01:00		37
h : min		°C

5.8.1.1 Creating a single-level program

1. Set the temperature control duration and temperature with the **time** and **temp** arrow keys.
2. Use the menu arrow keys to select *Save*. Confirm with the **menu/enter** key.

Entering the program name

P 06		
Cancel	◀ Save ▶	
◀	A B C D E F G H I J K L M	
	N O P Q R S T U V W X Y Z	
	1 2 3 4 5 6 7 8 9 0 _ ←	

3. Select letters or numbers with the menu arrow keys and confirm with the **menu/enter** key.

The program name can have a maximum of 15 characters.

To delete individual characters, select ← and press the **menu/enter** key.

4. To save the program with the program name, use the menu arrow keys to select *Save*.
5. Select the program slot with the menu arrow keys. Confirm with the **menu/enter** key.

5.8.1.2 Creating a multi-level program

1. Select an empty program slot in the *Menu > SmartBlock > Programs* menu item.

Defining step 1

2. Set the temperature control duration and temperature for the first program level with the **time** and **temp** arrow keys.

Adding step 2

3. Select *Options*. Confirm with the **menu/enter** key.

P 06 /Options	
Back	
Add step	◀▶
Delete step	
Ramp rates	

4. Select *Add step*. Confirm with the **menu/enter** key.

P 06		
Cancel	Save	◀ Options ▶
Step 1	01h:00m	37 °C
Step 2	10m:00s	56 °C

The set parameters have been adopted in step 1.

5. Set the parameters for the second program level.
 - To save the program with 2 program levels, select *Save*.
 - To program a third and a fourth program level, respectively select *Options > Add step*.
- i** To delete a step from a program, select *Options > Delete step*.

5.8.2 Restricting ramp rates

You can use the Eppendorf ThermoStat C to restrict the heating rate as well as the cooling rate. Restricted ramp rates can only be specified for programs.

Tab. 5-1: Heating rates and cooling rates

<i>Heating rate</i>	max. 3.0 °C/ min	max. 2.0 °C/ min	max. 1.0 °C/ min	max. 0.1 °C/ min	Maximum
<i>Cooling rate</i>	max. 3.0 °C/ min	max. 2.0 °C/ min	max. 1.0 °C/ min	max. 0.1 °C/ min	Maximum

1. Select an empty program slot under *Menu > SmartBlock > Programs*.
2. Set the temperature control duration and temperature with the **time** and **temp** arrow keys.
3. Select *Options*. Confirm with the **menu/enter** key.
4. Select *Ramp rates*. Confirm with the **menu/enter** key.

P 06 /Options/Ramp Rates	
Back	
Heating rate	◀ max 1.0 °C/min ▶
Cooling rate	maximal

5. Use the menu arrow keys to select and change *Heating rate* or *Cooling rate*.
6. To leave the *Ramp rates* menu, select the *Back* menu item. Confirm with the **menu/enter** key.



When you start a program that runs with restricted heating or cooling rates, a message is displayed: *The ramp rates of the program have been restricted.*

5.8.3 Loading a saved program

5.8.3.1 Loading a saved temperature

The keys above the display allow you to quickly select the temperature for setting a temperature control value for an unlimited time.

1. To call up a saved temperature, press a (**4 °C to 95 °C**) key.
 - The LED above the key lights blue.
 - The display shows saved parameters.
2. To start the temperature control procedure, press the **start/stop** key.

5.8.3.2 Loading a program from the program list

1. To load a program from the program list, select the program under *Menu > SmartBlock > Programs*. Confirm with the **menu/enter** key.
2. Use the menu arrow keys to select the *Load* menu item. Confirm with the **menu/enter** key.
 - The display shows the parameters of the program.
 - Programs with several program levels:

The display shows the parameters of the first program level. To display the parameters of the other program levels, use the ◀ or ▶ menu arrow keys to select the corresponding step.
3. To start the program, press the **start/stop** key.

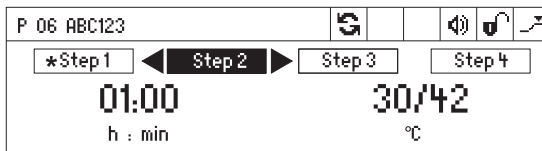

The asterisk marks the active program level Step 1. The display shows the parameters of Step 2.

i The order of the steps cannot be changed.

5.8.4 Editing programs

There are two ways to change a saved program:

- Change the program via the *Edit* menu item in the program list
- Change the program during operation

5.8.4.1 Changing the program via the *Edit* menu item in the program list

1. To change the parameters of a program, select the program under *Menu > SmartBlock > Programs*. Confirm with the **menu/enter** key.
2. Use the menu arrow keys to select the *Edit* menu item. Confirm with the **menu/enter** key.

The display shows the saved parameters.

You can change all the parameters and save them(see *Creating a program on p. 24*).

5.8.4.2 Changing the program during operation

1. Load the program from the program list.
2. Change the parameters.

For programs with program levels: Use the ◀ or ▶ menu arrow keys to select a step, change the parameters of the step.

3. Start the program.

After completion of the program, a message appears stating that the program has been changed. You can confirm or discard the changes.



5.8.5 Deleting programs

1. To delete a program, select the program under *Menu > SmartBlock > Programs*. Confirm with the **menu/enter** key.
2. Use the menu arrow keys to select the *Delete* menu item. Confirm with the **menu/enter** key.
The display shows the message *Confirm delete*. To confirm, press the **menu/enter** key.

6 Troubleshooting

If you cannot remedy an error with the recommended measures, please contact your local Eppendorf partner. The contact addresses can be found on the Internet at www.eppendorf.com.

6.1 General errors

Problem	Cause	Solution
Display remains dark.	No mains/power connection.	<ul style="list-style-type: none"> ▶ Check the mains connection and the power supply. ▶ Switch on the device.
Set temperature is not reached.	Set temperature is more than 30 °C below ambient temperature.	<ul style="list-style-type: none"> ▶ Set up the device in a cooler environment.
ThermoTop LED does not light.	<ul style="list-style-type: none"> • No thermoblock has been attached • The thermoblock is not compatible with ThermoTop. 	<ul style="list-style-type: none"> ▶ Use a compatible thermoblock with a <i>condens.protect</i> symbol: 
	The interface between the device and the ThermoTop is dirty.	<ul style="list-style-type: none"> ▶ Remove any dirt from the front of the ThermoTop. ▶ Remove any dirt from the top of the device, especially from the viewing window beside the heating/cooling plate.
ThermoTop does not fit on the device.	<ul style="list-style-type: none"> • The thermoblock is not compatible with ThermoTop. • The lid is attached to the thermoblock. 	<ul style="list-style-type: none"> ▶ Use a compatible thermoblock with a <i>condens.protect</i> symbol:  ▶ If using the ThermoTop, do not use the lid.
Device is not tempering.	Various causes are possible.	<ul style="list-style-type: none"> ▶ Contact your local Eppendorf partner.

6.2 Error messages

Problem	Cause	Solution
Thermoblock not detected.	<ul style="list-style-type: none"> • The thermoblock is not compatible with the device. • The thermoblock is not attached properly. 	<ul style="list-style-type: none"> ▶ Use a compatible thermoblock. ▶ Remove the thermoblock and then reattach it.
	<ul style="list-style-type: none"> • The interface between the device and the thermoblock is dirty. 	<ul style="list-style-type: none"> ▶ Remove any dirt from the bottom of the thermoblock. ▶ Remove any dirt from the top of the device, especially from the viewing window beside the heating/cooling plate.
Error message preceded by a number code.	<ul style="list-style-type: none"> • Various causes are possible. 	<ol style="list-style-type: none"> 1. Switch off the device and wait for 10 seconds. 2. Switch on the device. <p>If the error message appears again, contact your local Eppendorf partner.</p>
SmartExtender not detected by the device.	<ul style="list-style-type: none"> • Eppendorf ThermoStat C requires software version 3.0.0 or higher to detect the SmartExtender. 	<ul style="list-style-type: none"> ▶ Perform a software update. The software can be downloaded from the Eppendorf website.

7 Maintenance

7.1 Setting service intervals

The Eppendorf ThermoStat C offers the option of activating a reminder that the device needs to be serviced. To set a service interval, proceed as follows:

1. Under *Menu > Settings >* select the *Service* menu item. Confirm with the **menu/enter** key.
2. Select a service interval with the menu arrow keys (after 500, 1 000 or 2 000 operating hours).
To switch off the notification, select *No notification*.

When the specified operating hours have been reached, a message appears. Contact your local Eppendorf partner. The contact addresses can be found online at www.eppendorf.com/worldwide.

7.2 Cleaning



DANGER! Electric shock due to the ingress of liquid.

- ▶ Switch off the device and disconnect it from the mains/power line before starting cleaning or disinfection.
- ▶ Do not allow any liquids to penetrate the inside of the housing.
- ▶ Use sealed tubes and sealed plates.
- ▶ Do not perform a spray clean/spray disinfection on the housing.
- ▶ Only reconnect the device to the mains/power line when it is completely dry, both inside and outside.



WARNING! Risk of burns from hot surfaces.

The thermoblock, the SmartExtender and the heating/cooling plate reach high temperatures that can lead to burns.

- ▶ Allow the thermoblock, the SmartExtender and the heating/cooling plate to cool down before removing the SmartExtender or the thermoblock.



NOTICE! Damage from the use of aggressive chemicals.

- ▶ Do not use any aggressive chemicals on the device or its accessories, such as strong and weak bases, strong acids, acetone, formaldehyde, halogenated hydrocarbons or phenol.
- ▶ If the device has been contaminated by aggressive chemicals, clean it immediately using a mild cleaning agent.

**NOTICE! Corrosion due to aggressive cleaning agents and disinfectants.**

- ▶ Do not use any corrosive cleaning agents, aggressive solvents or abrasive polishes.
- ▶ Do not use any laboratory cleaners with sodium hypochlorite.

-
- ▶ Clean the housing of the Eppendorf ThermoStat C and the accessories regularly.

7.2.1 Cleaning the Eppendorf ThermoStat C**Auxiliary equipment**

- Lint-free cloth.
 - Mild, soap-based lab cleaner.
 - Dist. water
1. Switch off the Eppendorf ThermoStat C and disconnect it from the power supply.
 2. Allow the device to cool down.
 3. Clean all external parts of the Eppendorf ThermoStat C with a mild soap solution and a lint-free cloth.
 4. Wipe off the soap solution with dist. water.
 5. Dry all cleaned parts.

7.3 Disinfection/decontamination**DANGER! Electric shock due to the ingress of liquid.**

- ▶ Switch off the device and disconnect it from the mains/power line before starting cleaning or disinfection.
- ▶ Do not allow any liquids to penetrate the inside of the housing.
- ▶ Use sealed tubes and sealed plates.
- ▶ Do not perform a spray clean/spray disinfection on the housing.
- ▶ Only reconnect the device to the mains/power line when it is completely dry, both inside and outside.

Auxiliary equipment

- Lint-free cloth.
 - Disinfectant.
1. Switch off the Eppendorf ThermoStat C and disconnect it from the mains/power supply.
 2. Allow the device and the accessories to cool down.
 3. Clean the device and the accessories.
 4. Select a disinfection method that complies with the legal requirements and regulations in place for your range of application.
 5. Wipe the surfaces with the lint-free cloth and disinfectant.

7.4 Decontamination before shipment

If you are shipping the device to the authorized Technical Service for repairs or to your authorized dealer for disposal please note the following:



WARNING! Risk to health from contaminated device.

1. Observe the information in the decontamination certificate. It is available as a PDF document on our webpage (www.eppendorf.com/decontamination).
 2. Decontaminate all the parts you are going to dispatch.
 3. Include the fully completed decontamination certificate in the shipment.
-

7.5 Verification of temperature control

To verify the temperature accuracy of the thermoblock, use the Eppendorf Temperature Verification System – Single Channel. In combination with the temperature sensor for the Eppendorf ThermoStat C the exact temperature in the thermoblock can be measured.

Details on the verification process with the Eppendorf Temperature Verification System – Single Channel can be found in the corresponding operating manual.

8 Transport, storage and disposal**8.1 Transport****WARNING! Risk to health due to contaminated device and accessories.**

▶ Decontaminate the device and the accessories prior to storage and shipping.

	Air temperature	Relative humidity	Atmospheric pressure
General transport	-25 °C – 60 °C	10 % – 75 %	30 kPa – 106 kPa
Air freight	-40 °C – 55 °C	10 % – 75 %	30 kPa – 106 kPa

8.2 Storage**WARNING! Risk to health due to contaminated device and accessories.**

▶ Decontaminate the device and the accessories prior to storage and shipping.

	Air temperature	Relative humidity	Atmospheric pressure
In transport packing	-25 °C – 55 °C	10 % – 95 %	70 kPa – 106 kPa
Without transport packing	-5 °C – 45 °C	10 % – 95 %	70 kPa – 106 kPa

8.3 Disposal

If the product needs to be disposed of, the relevant legal regulations must be observed.

Information on the disposal of electrical and electronic devices in the European Community:

Within the European Community, the disposal of electrical devices is regulated by national regulations based on EU Directive 2012/19/EU pertaining to waste electrical and electronic equipment (WEEE).

According to these regulations, any devices supplied after August 13, 2005, in the business-to-business sphere, to which this product is assigned, may no longer be disposed of in municipal or domestic waste. To document this, they have been marked with the following marking:



Because disposal regulations may differ from one country to another within the EU, please contact your supplier if necessary.

Technical data

Eppendorf ThermoStat C

English (EN)

9 Technical data**9.1 Power supply**

Power connection	100 V – 130 V \pm 10 %, 50 Hz – 60 Hz 220 V – 240 V \pm 10 %, 50 Hz – 60 Hz
Power consumption	Maximum 200 W
Overvoltage category	II
Degree of pollution	2
Protection class	I

9.2 Weight/dimensions

Width	20.6 cm (8.1 in)
Depth	30.4 cm (12.0 in)
Height	13.6 cm (5.4 in)
Weight	4.4 kg (9.7 lb)

9.3 Ambient conditions

Environment	For indoor use only
Ambient temperature	5 °C – 40 °C
Relative humidity	10 % – 90 %, non-condensing
Atmospheric pressure	79.5 kPa – 106 kPa

9.4 Application parameters

9.4.1 Temperature control

Temperature control range	-10 °C – 110 °C, can be set in increments of 1 °C Minimum: 30 °C (± 2 °C) below the ambient temperature Maximum: 100 °C with SmartBlock 12 mm and SmartBlock cryo 110 °C	
Temperature accuracy	Set temperature 20 °C – 45 °C	Set temperature <20 °C or >45 °C
SmartBlock 1.5 mL	± 0.5 °C	± 1.0 °C
Temperature homogeneity	In the range of 20 °C – 45 °C max. ± 0.5 °C for all positions of the thermoblock	
Heating rate*	5.5 °C/min	
Cooling rate*	if the set temperature is above the ambient temperature if the set temperature is between ambient temperature and 30 °C below ambient temperature	Maximum 2.0 °C/min

*The heating rate and cooling rate can be restricted.



The heating and cooling rates refer exclusively to the thermoblock and can change with the filling volume in the tubes.

9.4.2 Time setting

Cycle times of 5 s to 99:30 h or unlimited.

Cycle time range	Step size
5 s – 1 min	5 s
1 min – 20 min	15 s
20 min – 1:00 h	1 min
1:00 h – 10:00 h	5 min
1:00 h – 99:30 h	30 min

Technical data

Eppendorf ThermoStat C

English (EN)

9.5 Thermoblocks

The following thermoblocks can be used with the Eppendorf ThermoStat C. Exchangeable thermoblocks for the Eppendorf Thermostat plus are not compatible.

Thermoblock	Tubes / plates	Maximum temperature	Accessories
SmartBlock <i>0.5 mL</i>	Micro test tubes volume 0.5 mL	100 °C	ThermoTop or Lid
SmartBlock <i>1.5 mL</i>	Micro test tubes volume 1.5 mL	100 °C	ThermoTop or Lid
SmartBlock <i>2.0 mL</i>	Micro test tubes volume 2.0 mL	100 °C	ThermoTop or Lid
SmartBlock <i>5.0 mL</i>	Micro test tubes volume 5.0 mL	100 °C	–
SmartBlock <i>12 mm</i>	Tubes with a diameter of 11 mm to 11.9 mm	110 °C	–
SmartBlock <i>cryo</i>	Cryogenic tubes	110 °C	–
SmartBlock <i>15 mL</i>	Conical tubes volume 15 mL	100 °C	–
SmartBlock <i>50 mL</i>	Conical tubes volume 50 mL	100 °C	–
SmartBlock <i>plates</i>	Microplates and deepwell plates with any kind of bottom contour.	100 °C	ThermoTop or Lid
SmartBlock <i>PCR 96</i>	96-well PCR plates 0.2 mL PCR tubes	100 °C	ThermoTop or Lid
SmartBlock <i>PCR 384</i>	384-well PCR plates	100 °C	ThermoTop or Lid
SmartBlock <i>DWP 500*</i>	Eppendorf Deepwell Plates 96/500 µL	100 °C	ThermoTop or Lid
SmartBlock <i>DWP 1000*</i>	Eppendorf Deepwell Plates 96/1000 µL	100 °C	ThermoTop or Lid

* SmartBlock *DWP 500* and SmartBlock *DWP 1000* can only be used with Eppendorf Deepwell Plates (optimal fit and temperature transfer).

9.6 Interface

USB interface	For connection to VisioNize and for software updates with the Eppendorf ThermoMixer Autoupdate.
---------------	---

10 Program data form

program	time	temp
1		
2		
3		
4		
5		
6		
7		
8		
9		
10		
11		
12		
13		
14		
15		

Declaration of Conformity

The product named below fulfills the requirements of directives and standards listed. In the case of unauthorized modifications to the product or an unintended use this declaration becomes invalid.

Product name:

Eppendorf ThermoStat C
including accessories

Product type:

Thermostat for test tubes and plates

Relevant directives / standards:

2014/35/EU: EN 61010-1, EN 61010-2-010, UL 61010-1, CAN/CSA C22.2 No. 61010-1
2014/30/EU: EN 55011, EN 61326-1
2011/65/EU: EN 50581

Date: June 06, 2016



Management Board



Portfolio Management

Your local distributor: www.eppendorf.com/contact
Eppendorf AG · 22331 Hamburg · Germany
eppendorf@eppendorf.com

Eppendorf® and the Eppendorf logo are registered trademarks of Eppendorf AG, Germany.
U.S. Design Patents are listed on www.eppendorf.com/ip.
All rights reserved, incl. graphics and pictures. Copyright 2016 © by Eppendorf AG.

www.eppendorf.com

ISO 9001
Certified

ISO
13485
Certified

ISO
14001
Certified



Evaluate Your Manual

Give us your feedback.

www.eppendorf.com/manualfeedback

Your local distributor: www.eppendorf.com/contact

Eppendorf AG · Barkhausenweg 1 · 22339 Hamburg · Germany
eppendorf@eppendorf.com · www.eppendorf.com

