



Operating Manual Freeze-dryer

ALPHA 1-4 LDplus

Part. No. 101541

ALPHA 2-4 LDplus

Part. No. 101542



CHRIST 
Freeze Dryers
Rotational-Vacuum-Concentrators

Operating Manual

ALPHA 1-4 LDplus ALPHA 2-4 LDplus

Order Number:

Serial Number:

In case of inquiries please state the above numbers.

© Copyright by
Martin Christ Gefriertrocknungsanlagen GmbH
An der Unteren Söse 50
37520 Osterode am Harz
Germany

Phone +49 (0) 55 22 / 50 07-0
Fax +49 (0) 55 22 / 50 07-12
E-mail: info@martinchrist.de
Internet: www.martinchrist.de

For service:

please use our **service request** form on our website:
www.martinchrist.de → [Service Area]

Phone +49 (0) 55 22 / 50 07-84 25
Fax +49 (0) 55 22 / 50 07-94 25
E-mail: service@martinchrist.de

Contents

1.	General Information	8
1.1.	Introduction	8
1.2.	Applications.....	9
1.3.	Technical Specification.....	10
1.3.1.	NOTE! Technical documentation!.....	11
1.4.	Scope of delivery.....	12
1.5.	Standards and Regulations.....	12
1.6.	Safety Instructions.....	12
1.6.1.	CAUTION! Disconnect Mains Plug!	12
1.6.2.	CAUTION! Solvents!	12
1.6.3.	ADVICE! Cleaning and Maintenance of the Unit!	13
1.6.4.	WARNING! Freezing of Limbs to Surfaces!	13
1.6.5.	ADVICE! Transport Instructions!.....	13
1.7.	Prohibited Freeze-drying Processes	14
2.	General Information on Freeze-drying	15
2.1.	General Information on Freeze-drying.....	15
2.2.	Preparation.....	18
2.3.	Freezing.....	18
2.4.	Main Drying.....	19
2.5.	Final Drying.....	22
2.6.	End of Drying and Aeration.....	22
2.7.	Defrosting.....	22
3.	Description of the Freeze-drying Processes	25
3.1.	Separate Freezing and Drying Outside the Ice Condenser Chamber (Process B) on Shelves	25
3.2.	Separate Freezing and Drying Outside the Ice Condenser Chamber (Process B) with Sealing Device.....	26
3.3.	Separate Freezing and Drying of Liquids in Flasks (Process B).....	27
3.4.	Separate Freezing and Drying of Liquids in Ampoules (Process B)	28
4.	Installation and Commissioning of the Unit	29
4.1.	Site of Installation	29
4.2.	Mains Electricity	29
4.3.	Fuses on Site	29
4.4.	Checking the Earth Connection	30
4.5.	Aeration.....	30
4.6.	Condensate and Defrosting Water	30
4.7.	Vacuum Pump Exhaust	31
4.8.	Initial Start-up	31
4.8.1.	Functional Components and Control Elements.....	32
4.8.2.	Connection of vacuum sensor vacuum Pump, and pressure control valve.....	33
4.8.3.	Diagram of the accessories	36
4.8.4.	Rubber valves.....	39
4.8.5.	Switching-on	40

5.	LDplus Control System	41
5.1.	Introduction	41
5.2.	LDplus control panel.....	41
5.3.	Brief Guide - Handling	41
5.4.	Visual components of the LDplus control system	42
5.4.1.	Main window	42
5.4.2.	Status bar	42
5.4.2.1.	Operating mode	42
5.4.2.2.	Active phase	43
5.4.2.3.	Info icon.....	43
5.4.3.	Softkey function	43
5.5.	Values window	44
5.6.	Mode.....	45
5.6.1.	Starting a drying process.....	45
5.6.2.	Changing the phase	45
5.6.3.	Timer	45
5.7.	Main menu	46
5.7.1.	Change set values	46
5.7.1.1.	Set values for freezing	47
5.7.1.2.	Set values for main drying & final drying.....	47
5.7.2.	Special functions.....	47
5.7.3.	Process and equipment information system	47
5.7.4.	Options	48
5.7.4.1.	Contrast.....	48
5.7.4.2.	Language.....	48
5.7.4.3.	Settings	48
5.7.4.4.	Service menu.....	49
5.7.5.	Tutorial	49
5.8.	Process and equipment information system	50
5.8.1.	Information status	50
5.9.	LDplus special functions	51
5.9.1.	Defrosting the ice condenser.....	51
5.9.2.	Electrical lifting device (option)	51
6.	Error Correction	53
6.1.	Power Failure	53
6.2.	Insufficient Vacuum	53
6.3.	Unit does not function.....	54
6.4.	Insufficient Ice Condenser Temperature.....	55
6.5.	Process and Equipment Information System.....	55
6.5.1.	Error Messages.....	55
7.	Maintenance and Service	57
7.1.	Maintenance.....	57
7.1.1.	Ice Condenser Chamber	57
7.1.2.	Heat Exchanger	57
7.1.3.	Vacuum Sensor VSP62/63.....	57
7.1.4.	Rubber Valves	58
7.1.5.	Vacuum Pump	58
7.1.6.	Exhaust Filter.....	58
7.1.7.	Cleaning	58
7.1.7.1.	Cleaning of the Freeze-dryer.....	58
7.1.7.2.	Cleaning of Accessories.....	58
7.1.7.3.	Maintenance of the Drying Chamber	59
7.1.7.4.	Maintenance of the Aeration Valve and the Drain Valve.....	59
7.1.8.	Disinfection of Drying Chamber, Lid and Accessories	60
7.1.9.	Checks by Operator	60
7.2.	Service.....	61
7.3.	Return of defective parts.....	62

8.	Options	63
8.1.	Process Control System LPC-32, Software	63
8.2.	Process Control System LPC-32, Software with PC hardware.....	63
8.3.	LyoLog LL-1 (Documentation Software).....	63
8.4.	LDplus Simulation Tool (Training Software)	63
8.5.	Electrical lifting device	63
9.	Enclosures	65

1. General Information

1.1. Introduction

What is freeze-drying (Lyophilisation)?

Freeze-drying means: Extraction of water from frozen material. The drying process takes place by avoiding the liquid state through sublimation, i. e. direct conversion from ice to vapour. This happens under vacuum and the temperature in the product is normally less than -10°C .

The aim of freeze-drying is to obtain an easily water soluble product which will have the same characteristics as the original product after addition of water.

As the drying process takes place in frozen state at very low temperatures it is possible to dry e. g. proteins which will not denature. Also most of the other chemical compounds will be qualitatively and quantitatively unchanged.

Through freeze-drying the product, mainly of biological origin - such as tissues, tissue extracts, bacteria, vaccines and sera - is transformed into a dry product. During this process enzymatic, bacterial and chemical changes are largely avoided.

Freeze-drying (lyophilisation) is the most gentle process for preserving the biological properties of sensitive tissue and tissue components.

Lyophilisation is also the best method when drying inorganic products – e.g. nanoscale dispersions – the particle surfaces of which should remain unchanged.

1.2. Applications

The freeze-dryer **ALPHA 1-4 LD_{plus}** / **ALPHA 2-4 LD_{plus}** is a high-performance universal laboratory and pre-production unit for freeze-drying of solid or liquid products in ampoules, vials, glass flasks, plasma bottles or dishes. All operations necessary for freeze-drying can be realized in one and the same unit:

- Freezing of the products (uncontrolled shelf surface temperature)¹
- Freeze-drying (sublimation) of the products at user-defined temperature limit values and pressure limit values
- Final drying of the products at user-defined temperature limit values and high final vacuum for the removal of capillary or molecularly bound water.

The freeze-dryer **ALPHA 1-4 LD_{plus}** / **ALPHA 2-4 LD_{plus}** is suitable for drying of e. g. bacteria and virus cultures, blood plasma, serum fractions, antibodies, sera, vaccines and pharmaceutical products such as chloramphenicol, streptomycin, vitamins, ferments as well as plant extracts for biochemical tests.

¹ Normally done separately in a deep-freeze

1.3. Technical Specification

	ALPHA 1-4 LD _{plus}	ALPHA 2-4 LD _{plus}
Performance data		
Ice condenser capacity	max. 4kg	max. 4kg
Ice condenser performance ¹⁾	max. 4kg/24h	max. 4kg/24h
Ice condenser temperature ¹⁾	approx. -55°C	approx. -85°C
Ice condenser chamber volume:	approx. 6,5l	approx. 6,5l
Max. shelf surface area when drying outside the ice condenser chamber (process B):	5 shelves, Ø265 A _{total} 0.28m ² spacing: 79mm with accessory no. 120902 or 5 shelves, Ø360 A _{total} 0.51m ² spacing: 70mm with accessory no. 120916	5 shelves, Ø265 A _{total} 0.28m ² spacing: 79mm with accessory no. 120902 or 5 shelves, Ø360 A _{total} 0.51m ² spacing: 70mm with accessory no. 120916
Max. shelf surface area when drying in injection vials with sealing under vacuum or nitrogen atmosphere outside the ice condenser chamber (process B):	4 shelves, Ø250 A _{total} 0.18m ² spacing: max. 50mm with accessory no. 121011	4 shelves, Ø250 A _{total} 0.18m ² spacing: max. 50mm with accessory no. 121011
Drying in round bottom flasks. Please note that the max. ice condenser capacity is 4kg (process B):	12 pieces resp. 24 pieces	12 pieces resp. 24 pieces
Physical data (without vacuum pump):		
Dimensions of the unit:	width: 390mm height: 415mm depth: 555mm (incl. vacuum-flange connection)	width: 390mm height: 415mm depth: 555mm (incl. vacuum-flange connection)
Weight:	approx.42kg	approx.55kg
Noise emissions according to DIN 45635:	54 dB(A)	54 dB(A)

	ALPHA 1-4 LD _{plus}	ALPHA 2-4 LD _{plus}
Electromagnetic compatibility according to EN 55011:	class B	class B
Filling quantities:		
Refrigerant:	see label on the back of the unit	see label on the back of the unit
Connection requirements with vacuum pump 0.4KVA:		
Electrical connection:	1 x 230V / 50-60 Hz (others upon request)	1 x 230V / 50-60 Hz (others upon request)
Power consumption:	1,3kVA	2kVA
Max. current:	5,5 A	8A
Fuse protection:	10A	12A
Ambient temperature:	+10°C to +25°C (higher temperatures upon request)	+10°C to +25°C (higher temperatures upon request)
Equipment connections:		
Vacuum connection:	Small flange connection DN 25 KF (ISO 28403, DIN 2861)	Small flange connection DN 25 KF (ISO 28403, DIN 2861)
Drain valve and Aeration valve:	Hose nozzle DN10 (outside diameter 12mm)	Hose nozzle DN10 (outside diameter 12mm)

¹⁾ **All machine specifications (especially for temperatures, power and capacity) refer to the nominal ambient temperature of 20°C.**

1.3.1. NOTE! Technical documentation!

The technical documentation of the freeze-dryer **ALPHA 1-4 LDplus / ALPHA 2-4 LDplus** (e.g. circuit diagram, cooling system) and the safety data sheets of the manufacturers of refrigerant and heat transfer medium is not attached to this operating manual.

Please ask for the documents in case of need via Internet at www.martinchrist.de by using the form "**service request**".

1.4. Scope of delivery

The scope of delivery includes:

- 1 tube of high-vacuum grease
- 1 litre vacuum pump oil (only in case a pump is delivered)
- 0.5 m drain hose (silicone 9 x 12 mm)
- 1 operating manual and further detailed technical documentation

The scope of delivery does not include:

- Commissioning of the unit (inside Germany) can be performed upon request and will be invoiced at cost.
- Installation of the exhaust pipe of the vacuum pump (not necessary when using an exhaust filter).

1.5. Standards and Regulations

Please refer to the enclosed EU Declaration of Conformity.

1.6. Safety Instructions

1.6.1. CAUTION! Disconnect Mains Plug!



As current-carrying parts are accessible inside the unit the mains plug must be disconnected before the side panels are opened or before the control panel is removed.

For maintenance work the unit must be switched off with the mains switch.

1.6.2. CAUTION! Solvents!



Acidic products or products with a high solvent concentration cannot be dried without special protective measures and devices such as e.g. a cooling trap for protection of the vacuum pump (if necessary check with our service department). Besides, the unit may be damaged by corrosion.

Special caution is necessary when using azides because a dangerous explosive develops in combination with copper or non-ferrous metals! It is absolutely essential to consult our service department!

1.6.3. **ADVICE! Cleaning and Maintenance of the Unit!**



For infectious, toxic, pathogenic and radioactive substances the corresponding safety regulations must be observed.

1.6.4. **WARNING! Freezing of Limbs to Surfaces!**



During operation of the freeze-dryer dangerous situations in the ice condenser chamber may arise. When putting in the shelves take care that limbs do not come into contact with the condenser in the ice condenser chamber as the limbs may become frozen to the surface. The limb can only be detached from the surface by applying heat. Liquid should not be used.

1.6.5. **ADVICE! Transport Instructions!**

Please keep the packaging for possible subsequent dispatch.

The freeze-dryer should be carried by two persons by holding it underneath on both sides.

WARNING! When transporting or putting down the unit do not hold the plastic control panel. Please note: When putting the unit down on a surface there is a danger of squeezing hands or fingers.



WRONG



CORRECT

1.7. Prohibited Freeze-drying Processes

1. Operation of freeze-dryer when not installed correctly.
2. Operation of freeze-dryer without panels.
3. Operation of freeze-dryer by non-authorized personnel.
4. Operation of freeze-dryer with shelves not installed properly.
5. Operation of freeze-dryer with very corrosive substances (e.g. hydrogen chloride). It is not allowed to dry these substances, at least special safety measures have to be observed. The corrosive substances must not cause damage to material and must not degrade the mechanical strength of the ice condenser chamber, the drying chamber, the lid or the accessory components.
6. Operation of freeze-dryer with accessories not allowed by the manufacturer, except for commercial freeze-drying vessels made of glass or plastic. The user is explicitly warned not to use poor quality goods. Breaking glass or bursting vessels can cause dangerous situations during freeze-drying.
7. Operation of freeze-dryer in locations with danger of explosion.
8. During operation the freeze-dryer must not be knocked or moved. Leaning against or resting on the freeze-dryer is not allowed.
9. Do not place potentially dangerous material, e. g. glass vessels containing liquids, near the freeze-dryer.
10. Products which could react to the supply of high energy during the freeze-drying process must not be dried.
11. Do not freeze-dry explosive or highly inflammable substances.
12. Infectious, toxic, pathogenic and radioactive substances must only be dried in suitable vessels.

2. General Information on Freeze-drying

2.1. General Information on Freeze-drying

Freeze-drying is the most gentle process for drying products. It is based on the physical phenomenon of sublimation i.e. the direct conversion from solid to gaseous state. The frozen product is placed in the vacuum drying chamber for drying. The ice condenser can also be described as a vapour pump as the moisture which evaporates under vacuum during drying freezes onto the ice condenser. Consequently the vacuum pump is only intended to remove the air from the drying chamber (=gas pump) but not the vapour. In order to start the sublimation process, energy must be supplied to the product. This takes place during drying in round bottom flasks or wide-neck filter bottles etc. due to the much warmer environment (direct heat contact), on unheated shelves by means of heat radiation from the environment and directly by means of the shelves when heatable. Once the "free water" has been removed from the product, it is also possible to remove the marginally contained adsorptively bound water by means of very low vacuum. This part of the drying process is referred to as final drying (desorption).

The main components of a freeze-dryer are :

Vacuum drying chamber with heating device

- a) heatable² and unheatable shelves for drying in dishes
- b) shelves with sealing device for drying in bottles
- c) rubber valves for connecting round bottom flasks, wide-neck filter bottles, etc.
- d) manifold for connecting round bottom flasks, wide-, neck filter bottles, etc.

Pumps to evacuate air and water vapour

- a) vacuum pump to evacuate the drying chamber (= gas pump)
- b) ice condenser with temperatures from -50°C to -105°C (depending on type of unit) to remove the water vapour from the chamber (= vapour pump)

² Heatable (controlled) shelves are only possible with an LSC control system.

Sublimation

The principle of sublimation is briefly explained using the phase diagram of water (freeze-drying of mainly aqueous solutions, see vapour pressure curve). If the atmospheric pressure is higher than 6.11 mbar, water passes through all three phases (solid, liquid, gas) when the temperature is lowered or raised. At 6.11 mbar the melting pressure curve, vapour pressure curve and sublimation pressure curve meet in one point called triple point. At this point all three phases occur in parallel (simultaneously). Below this point, i.e. the pressure is lower than 6.11 mbar, the ice is converted directly from a solid to a gaseous phase on reaching the sublimation pressure curve (vapour pressure curve above ice).

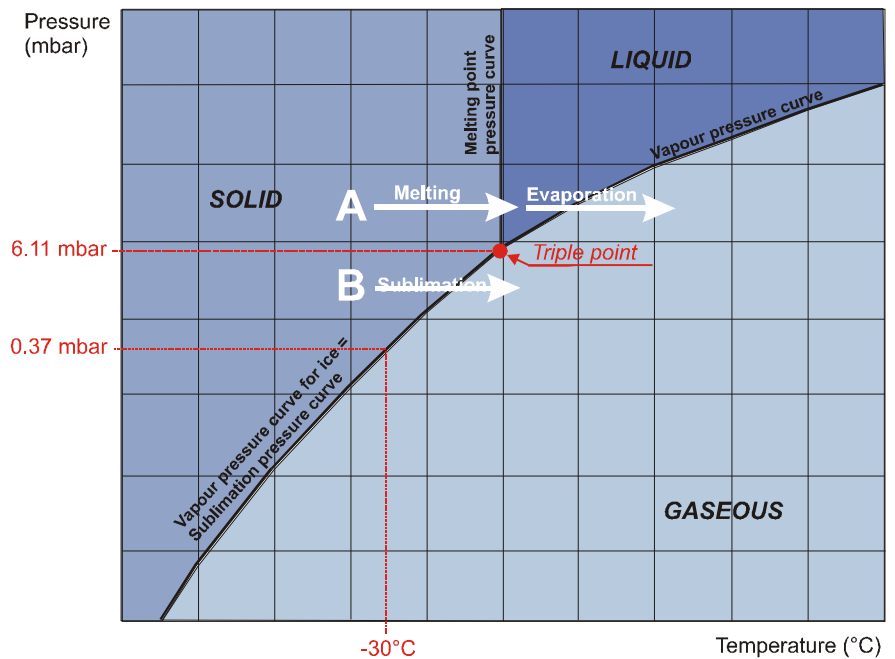

Conversion table "Vapor pressure above ice" (sublimation curve)

Pressure units: **1mbar = 100Pa**
 1Pa = 0.01mbar

Temperature units: $T = t + 273$
 $t = T - 273$
 $t_F = 1.8 \cdot t + 32$
 $t = \frac{t_F - 32}{1.8}$

T = thermodynamic temperature **K (Kelvin)**
t = temperature in degree Celsius **°C**
t_F = temperature in degree Fahrenheit **°F**

°C	△mbar	°C	△mbar	°C	△mbar	°C	△mbar
0	6,110	-20	1,030	-40	0,120	-60	0,011
-1	5,620	-21	0,940	-41	0,110	-61	0,009
-2	5,170	-22	0,850	-42	0,100	-62	0,008
-3	4,760	-23	0,770	-43	0,090	-63	0,007
-4	4,370	-24	0,700	-44	0,080	-64	0,006
-5	4,020	-25	0,630	-45	0,070	-65	0,0054
-6	3,690	-26	0,570	-46	0,060	-66	0,0047
-7	3,380	-27	0,520	-47	0,055	-67	0,0041
-8	3,010	-28	0,470	-48	0,050	-68	0,0035
-9	2,840	-29	0,420	-49	0,045	-69	0,0030
-10	2,560	-30	0,370	-50	0,040	-70	0,0026
-11	2,380	-31	0,340	-51	0,035	-71	0,0023
-11	2,170	-32	0,310	-52	0,030	-72	0,0019
-13	1,980	-33	0,280	-53	0,025	-73	0,0017
-14	1,810	-34	0,250	-54	0,024	-74	0,0014
-15	1,650	-35	0,220	-55	0,021	-75	0,0012
-16	1,510	-36	0,200	-56	0,018	-76	0,0010
-17	1,370	-37	0,180	-57	0,016	-77	
-18	1,250	-38	0,160	-58	0,014	-78	
-19	1,140	-39	0,140	-59	0,012	-79	

The process steps of freeze drying

Freezing

Under atmospheric pressure
(e. g. at -25°C)

= Formation of the ice structure

Drying

Under vacuum
e. g. at 0,01 mbar

= Keeps the water contents in
ice phase



Additionally necessary
Energy input (= heat)

but: the material remains in the
solid/ice phase

(Physical law: the vacuum is
responsible for the product
temperature)

2.2. Preparation

In case the unit is equipped with a pressure control valve the vacuum pump should be warmed up. The operation temperature should be reached before loading the vacuum pump with condensable gases. In this way, the service life of the vacuum pump can be considerably extended.

The vacuum pump can be operated already during the freezing process when the pressure control valve is closed. The vacuum pump should be warmed up for at least 15 minutes or it should be switched on at least 15 minutes before starting the main drying process.

It may occur that the vacuum in the ice condenser chamber or in the drying chamber goes up during the main drying process (e.g. from 0.63 mbar to 0.47 mbar) although the valve to the vacuum pump is closed. This can be explained physically by the pumping effect of the ice condenser ("Cryo Pumping Effect").

2.3. Freezing

Small product quantities are frozen directly inside the ice condenser chamber of the freeze-dryer. Larger quantities are pre-frozen in a deep-freeze.

If liquids are to be dried in bottles with a layer thickness of more than 1 cm we recommend that pre-freezing is carried out with a shell or spin freezing device in a cooling bath (see picture). Due to the centrifugal force the liquid to be frozen will rise on the wall of the bottle and freeze. With this freezing process the layer thickness is reduced and thus the total drying period is shortened considerably.



Cooling bath with spin freezing device

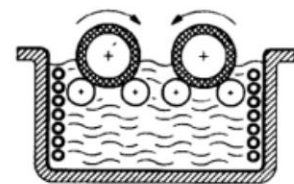

Shell freezing diagram



Spin freezing diagram

Freezing inside the unit is not necessary if the product is pre-frozen or stored in e. g. a deep-freeze. In this case, especially when freeze-drying small quantities, it is advisable to pre-cool the shelves in order to avoid partial thawing during the evacuation.

Possible water residue must be removed from the ice condenser chamber. The drain valve is closed.

The ground-in stopper of the drying chamber must be greased with high-vacuum grease!

The layer thickness of the product should not exceed 1 to 2 cm as otherwise this has a negative effect on the duration of the drying process.

2.4. Main Drying

The vacuum pump is switched on.

Please note:

Defrosting during the drying process is possible (visible foaming) when drying products containing e. g. solvents or high salt concentrations. In this case it is necessary to freeze the product at temperatures as low as possible, e.g. in liquid nitrogen.

Warning:

Acidic products or products with a high solvent concentration cannot be dried without special safety measures and devices e.g. an additional LN₂ cooling trap for protection of the vacuum pump (if necessary contact our company). Another possibility is to use chemical resistant vacuum hybrid pumps (e.g. RC-5).



Special precautions are necessary when using azides because a dangerous explosive develops in combination with copper or non-ferrous metals! It is absolutely essential to consult our company!

As soon as sublimation of the water vapour from the frozen product begins, heat is extracted and consequently the product continues to cool down.

The maximum rate of sublimation is reached at the start of the drying process.

Depending on the rate of sublimation the ice condenser temperature and thus the pressure in the drying chamber respectively ice condenser chamber rises.

The duration of the main drying phase depends mainly on:

- the layer thickness of the product,
- the solid content of the product,
- the heat supplied to the product during the drying process,
- the pressure inside the drying chamber during the drying process.

With increasing pressure (not vacuum!) the rate of sublimation rises and the drying period is shortened.

The water vapour generated during the main drying phase is not pumped off by the vacuum pump but collected by the ice condenser.

The purpose of the vacuum pump is to lower the partial pressure of the non-condensable gases so that the water vapour can be transported from the product to the ice condenser.

During the main drying phase the moisture is removed by sublimation, during final drying the bound moisture is removed by desorption.

The residual moisture of the dried product depends mainly on:

- the temperature of the dried product during the final drying process,
- the final vacuum reached during the final drying process.

The end of the main drying phase is reached, when the product temperature is nearly the same as the shelf temperature (temperature difference between shelf and product approx. 3 K to 5 K). If the adsorptively bound water is to be removed from the product, the final drying phase can be started.

The following picture shows the drying process for a product containing approx. 10 % solid matter. During the first quarter of the main drying phase 50 % of the water content is condensed. During the next quarter of the main drying phase 50 % of the remaining water content is condensed. This continues until the drying curve approaches the time axis asymptotically. This typical drying curve is due to the fact that the area of sublimation recedes into the product and the water vapour still to be extracted has to pass through the already dried layers. During the drying process the inner resistance increases. Thus the drying curve is primarily determined by the latent heat of sublimation and the water vapour transport speed. In order to increase the specific heat conduction properties of the product to be dried and to keep the water vapour volume as low as possible it is necessary that drying takes place as close as possible to the solidification point (eutectic point).

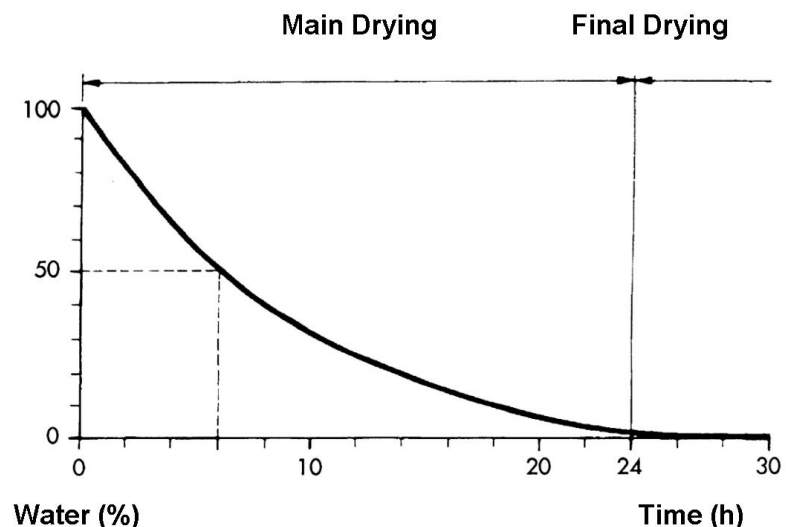

The drying time depends heavily on the drying vacuum. The nearer the vacuum is to the solidification point in accordance with the vapour pressure curve above ice, the shorter the drying time is.

Interesting correlations :

- 1.0 gram of ice at
- 1.0 mbar assumes a volume of 1 m³ vapour
- 0.1 mbar assumes a volume of 10 m³ vapour
- 0.01 mbar assumes a volume of 100 m³ vapour

Heat Supply during Drying

The required heat supply to the product to be dried takes place through direct heat contact in the drying chamber, heat conduction through gas or through radiation. Heat transfer by direct contact and heat conduction through gas are the most usual sources of heat in today's freeze-dryers. The constraints caused by the former can be seen in the following diagram.

Effects of freeze drying of a product in a dish

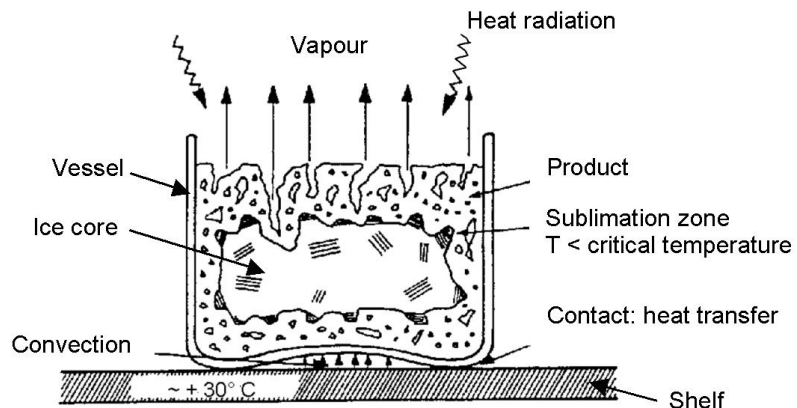

Heat transfer takes place via the heated shelves by direct contact with the bottom of the vessel and/or by convection via the shelf and vessel or product.

At the beginning of sublimation the transfer of heat is very effective from the wall of the vessel to the frozen product. However, soon an area develops which is ice free, porous and dried and has a corresponding temperature gradient between the wall of the vessel and the product. The poor heat conductivity of the already dried product can lead to an increase in temperature of the ice core. If the core temperature rises above the solidification temperature, the product begins to thaw. This applies especially to inhomogeneous products and to great layer thicknesses. During this drying phase it is important to regulate the heat supply and control temperature and pressure precisely.

2.5. Final Drying

The final pressure in the drying chamber depends on the ice condenser temperature according to the vapour pressure curve above ice :

- e. g. 1.030 mbar correspond to -20°C
- 0.370 mbar correspond to -30°C
- 0.120 mbar correspond to -40°C
- 0.040 mbar correspond to -50°C
- 0.011 mbar correspond to -60°C

The unit is in operating condition if the temperature of the ice condenser is lower than -50°C and the pressure is lower than 0.120 mbar.

The final pressure measured by the vacuum sensor when there is no product in the unit and its corresponding ice temperature value is mainly determined by the warmest place of the ice on the ice condenser chamber. Moreover, this value is affected by residues or parts of solvents in the product with a higher vapour pressure.

2.6. End of Drying and Aeration

A rough indication of the end of drying are the vacuum and the ice condenser temperature. The ice condenser is no longer loaded and reaches the final temperature of approx. -55°C to -85°C. The pressure in the drying chamber decreases according to the ice condenser temperature.

The vacuum pump is switched off and the drying chamber is vented via a rubber valve or the aeration valve on the left side of the unit. The aeration valve can also be used to “flood” the unit with nitrogen or another inert gas instead of using air.

CAUTION! Maximum overpressure 0.2 bar!

Then the unit is switched off and the product is removed.

2.7. Defrosting

If the freeze-dryer is not equipped with a defrosting device, defrosting of the ice condenser is carried out at room temperature or with warm water. At a maximum the ice condenser chamber may be half filled with water.

When defrosting the ice condenser with (warm) water, it is of crucial importance that no water gets into the pipe connection for the vacuum pump and the vacuum sensor (see figure)!

The condensate as well as the defrosting water are drained through the drain valve at the left side of the unit. To do this, a hose is put onto the nozzle. The condensate and the defrosting water are collected in a vessel.

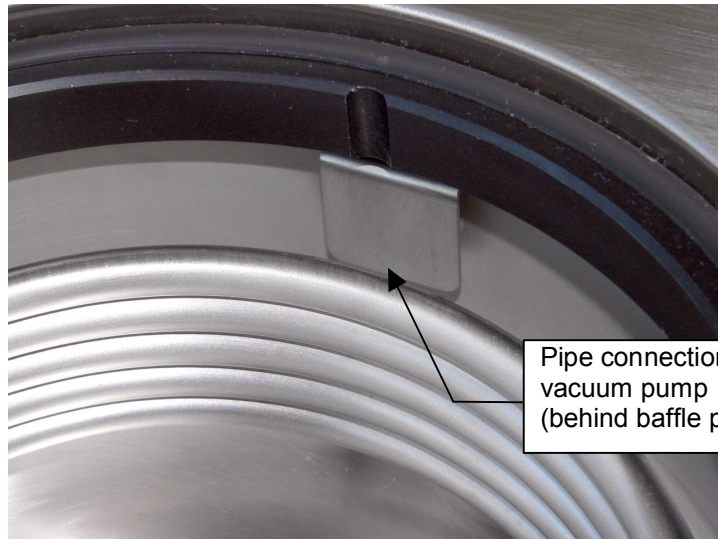

Pipe connection for
vacuum pump
(behind baffle plate)

3. Description of the Freeze-drying Processes

3.1. Separate Freezing and Drying Outside the Ice Condenser Chamber (Process B) on Shelves

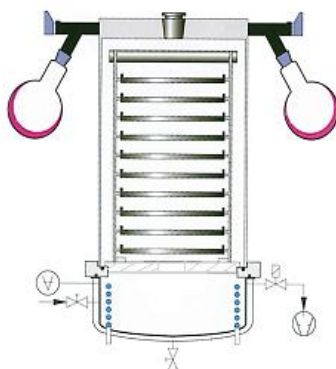

It is also possible to dry the product outside the ice condenser chamber. In this case, the product has to be frozen e.g. in a deep-freeze.

Possible water residue is removed from the ice condenser chamber. The drain valve is opened so that the water residue can drain off. The ice condenser chamber should be wiped out if necessary.

The refrigeration compressor and the vacuum pump are activated via the control system to start the pre-freezing of the ice condenser and the warming-up of the vacuum pump. The valve is closed during warming-up of the pump. In case the unit is not equipped with an electromagnetic pressure control valve we recommend to use a manual stop valve. Without such a valve the vacuum pump must not be warmed up.

The rack is set onto the base plate. With small samples it is recommended to pre-cool the shelves. In this way, a partial thawing during the evacuation process is avoided.

When freezing and drying is performed separately outside the ice condenser chamber it is directly started with the main drying process.

As soon as the shelves with the frozen samples have been put in, the unit and the drying chamber are sealed and the process is started. To do so, the main drying process has to be activated in the control system so that the pressure control valve opens and the main drying process starts (see chapter 5.6).

3.2. Separate Freezing and Drying Outside the Ice Condenser Chamber (Process B) with Sealing Device

Possible water residue is removed from the ice condenser chamber. The drain valve is opened so that the water residue can drain off. The ice condenser chamber should be wiped out if necessary.

The refrigeration compressor and the vacuum pump are activated via the control system to start the pre-freezing of the ice condenser and the warming-up of the vacuum pump. The valve is closed during warming-up of the pump. In case the unit is not equipped with an electromagnetic pressure control valve we recommend to use a manual stop valve. Without such a valve the vacuum pump must not be warmed up.

The rack is set onto the base plate. With small samples it is recommended to pre-cool the shelves. In this way, a partial thawing during the evacuation process is avoided.

The sealing device is used to seal injection bottles under vacuum or inert gas with ribbed rubber stoppers. Depending on the type of sealing device the bottles are sealed on 1 to 2 shelves. To do this, the shelves are moved against each other by a pressure plate using a spindle.

The height of the pressure plate must be adjusted according to the height of the bottles. To do so the threaded pin for height adjustment is removed. The threaded rod is screwed into the lower shelf until its slotted head is on the same height as the rack (upper edge).

Then the pressure plate is fastened with the threaded pin in such a way that it will rest on or slightly above the rubber stopper. When using two or more shelves every shelf is set directly on or with a slight distance to the rubber stoppers as it is the case for the pressure plate.

Instead of the stopper the vacuum-tight rotary leadthrough is put into the standard ground socket of the drying chamber. Before inserting, the ground-in surface of the leadthrough is greased with vacuum grease.

After completion of the drying process the lever of the rotary leadthrough is turned to the right until a resistance is felt.

For the sealing of the bottles the shelf must be completely filled. For small quantities at least three spacers must be evenly put on each shelf (according to the height of the bottles with inserted rubber stoppers).

The appropriate spacers are available upon request.

3.3. Separate Freezing and Drying of Liquids in Flasks (Process B)

Possible water residue is removed from the ice condenser chamber. The drain valve is opened so that the water residue can drain off. The ice condenser chamber should be wiped out if necessary.

The refrigeration compressor and the vacuum pump are activated via the control system to start the pre-freezing of the ice condenser and the warming-up of the vacuum pump. The valve is closed during warming-up of the pump. In case the unit is not equipped with an electromagnetic pressure control valve we recommend to use a manual stop valve. Without such a valve the vacuum pump must not be warmed up.

Several manifolds and mountable drying chambers with several connections for rubber valves are available for the drying process outside the ice condenser chamber (see accessories catalogue). The drying chamber with connections for rubber valves is mounted directly to the sealing ring of the base plate. Manifolds with outer ground joints NS 45/40 are connected via the ground-in socket of the acrylic lid.

In order to ensure a vacuum-tight connection and to simplify the removal of the named accessories the ground-in surface must be slightly greased with vacuum grease before use. The manifold or drying chamber is mounted afterwards and turned by 360° for an even distribution of the grease.

The ground-in surfaces have to be cleaned and greased before every further mounting of accessories.

Before the drying process can start it is necessary to check that all valves are closed.

To start the drying process, the main drying process has to be activated in the control system. The pressure control valve opens and the main drying process starts.

Caution: The frozen samples can only be connected to the valves when a pressure of less than 1.030 mbar is reached.

Liquids are frozen in flasks according to the shell freezing principle, manually or with a turning device. Thanks to this freezing process the layer thickness is reduced and the drying period is considerably shortened.

Most of the manifolds and valves available allow a continuous connection and removal of flasks during the drying process. Each rubber valve is equipped with a closing and aeration valve.

If the rubber valves or stainless steel valves are stiff they must be dismantled, cleaned, slightly greased with vacuum grease and reassembled.

It is also possible to connect a distributor for 15 ampoules to every rubber valve.

Using a distributor a maximum of 15 ampoules can be simultaneously frozen in the cooling bath and connected to the manifold.

3.4. Separate Freezing and Drying of Liquids in Ampoules (Process B)

The refrigeration compressor and the vacuum pump are activated via the control system to start the pre-freezing of the ice condenser and the warming-up of the vacuum pump. The valve is closed during warming-up of the pump. In case the unit is not equipped with an electromagnetic pressure control valve we recommend to use a manual stop valve. Without such a valve the vacuum pump must not be warmed up.

The manifold is equipped with blind plugs for connection of a maximum of 48 ampoules so that it can be pre-evacuated.

The first hose is clamped in the middle with the supplied hose clamp and the blind plug is removed. The vacuum of the system is preserved.

The liquid in the ampoule is either frozen under rotation in a cooling bath or in a deep-freeze.

If shock-freezing is required we recommend that freezing is carried out in liquid nitrogen or in a cooling bath.

The ampoule is then connected to the hose and the hose clamp is removed. Thus the partial pressure in the ampoule is suddenly decreased and a partial thawing during the evacuation process is avoided.

One ampoule after the other is connected using this method.

Sealing of the ampoule is carried out in the same way. The hose of the ampoule to be sealed is clamped and the ampoule is sealed under vacuum using the blow lamp.

If the ampoule breaks during sealing the vacuum in the drying chamber is not affected due to the clamping with the hose clamp.

The remaining glass from the ampoule is removed and the hose is closed with a blind plug.

In this way one ampoule after the other can be sealed or new ampoules can be connected.

4. Installation and Commissioning of the Unit

4.1. Site of Installation



WARNING! Papers, cloths or similar items must not be put behind the unit as the air circulation of the heat exchanger will not work any more.

The freeze-dryer should be horizontally aligned. The ambient temperature should be within approx. +10°C and +25°C.

The refrigeration compressor of the freeze-dryer is air-cooled. Sufficient air circulation must be ensured. A distance of at least 30 cm to the wall should be kept. The unit should not be positioned near radiators or heat sources and direct insolation must be avoided.

In case of insufficient air circulation or too high ambient temperatures pressure and/or temperature in the refrigerating system will increase. This may cause an exceeding of the admissible operation pressure and thus a breakdown of the freezing unit.

The following connections are required at the site:

4.2. Mains Electricity

The operating voltage on the name plate must correspond to the local supply voltage.

CHRIST freeze-dryers are units of safety class I. The units of the type **ALPHA 1-4 LDplus / ALPHA 2-4 LDplus** are equipped with a three-wire power cord with a IEC C13 connector (see also chapter 1.3 "Technical specification").

4.3. Fuses on Site

The freeze-dryer must be protected typically with a 16 AG fuse.

4.4. Checking the Earth Connection

For checking the earth connection there is a screw for equalising the ground potential on the rear panel of the freeze-dryer. The check can be carried out by means of an appropriate measuring device.

4.5. Aeration

The aeration and drain valve at the lower left side of the unit is used to vent the ice condenser chamber.

In case penicillin bottles have to be sealed under nitrogen instead of vacuum, the ice condenser chamber can be flooded with nitrogen via the nozzle of the aeration valve.

CAUTION! Max. 0.2 bar overpressure!

4.6. Condensate and Defrosting Water

The condensate and defrosting water is drained via the aeration and drain valve on the lower left side of the unit. To drain the water, connect the hose supplied with the unit to the nozzle. The condensate and defrosting water are collected in a vessel.

The condensate and defrosting water can also be drained directly via this hose. The condensate and defrosting water must be able to drain freely. To achieve this, the hose must have a steady downward slope. It must be ensured that water does not collect in any part of the hose. The end of the hose always has to be above the level of the liquid in the vessel for the discharged liquids. Otherwise there is the risk of water and dirt residues being sucked into the ice condenser chamber if there is a negative pressure when opening the drain valve.

The drain valve is also used to vent the unit when a freeze-drying process has been completed.

4.7. Vacuum Pump Exhaust

The oil mist which is produced during operation of the vacuum pump must be removed.

A ½" hose can be connected to the exhaust flange of the vacuum pump RZ-2 or RC-5 and a ¾" hose is connected to the exhaust flange of the vacuum pump DUO 5 or DUO 10. The hose either leads into the open air or into a vent.

During installation of the pipe care must be taken that condensate cannot flow back into the pump. With upward leading pipes it is safest to use a separator (Woulfe's bottle or wash bottle) in the pipe.

We strictly recommend using an exhaust filter (oil mist separator). This filter prevents air pollution by oil mist which is emitted by the vacuum pump in different quantities depending on the working pressure.

The filter is fastened to the exhaust flange of the vacuum pump.

The filter is equipped with a pressure relief valve indicating the saturation of the filter. Cleaning or replacing of the filter insert must be carried out at the latest when the pressure relief valve is activated. The collected oil is visible in the inspection glass and is drained via the discharging screw.

Please refer to separate operating manual of the vacuum pump!

4.8. Initial Start-up

CAUTION! Ensure that the freeze-dryer is correctly mounted and installed before initial start-up (see point 4.1 Site of Installation and following points).

4.8.1. Functional Components and Control Elements



Aeration and drain valve



Ice condenser chamber

Ice condenser

LD_{plus} control system

Mains switch



Vacuum connection

Additional connection interface (option, sep. accessories)

Serial interface for vacuum sensor

Vacuum pump

Pressure control and stop valve

Mains fuse protection

Mains cable

Potential equalising screw for protective ground wire check and central earth connection

Name plate

Heat exchanger of the refrigeration unit

4.8.2. Connection of vacuum sensor vacuum Pump, and pressure control valve

Connection diagram

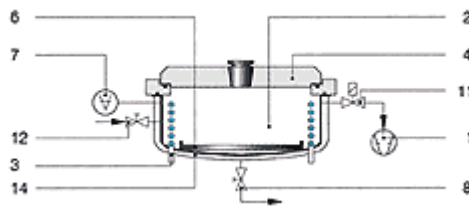

Fig. 1

Process A (single-chamber system):

Freezing and gentle drying of low-freezing and thermolabile substances on cooled shelves inside the ice condenser chamber (see figure 1).

Typical drying vessels::

Dishes

Injection vials (can be sealed under vacuum)

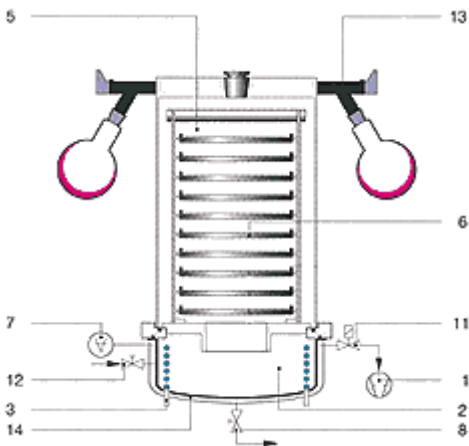

Fig. 2

Process B (double-chamber system):

Separate freezing (e.g. in a deep-freeze) and drying outside the ice condenser chamber (see figure 2)

Typical drying vessels:

Dishes

Injection vials (can be sealed under vacuum)

Round-bottom flasks, wide-neck filter bottles

Ampoules

- | | |
|-------------------------|---------------------------|
| 1 Vacuum pump | 7 Vacuum sensor |
| 2 Ice condenser chamber | 8 Drain valve |
| 3 Ice condenser | 11 Pressure control valve |
| 4 Glass lid | 12 Aeration valve |
| 5 Drying chamber | 13 Rubber valve |
| 6 Heatable shelf | 14 Thermal insulation |

The accessory components are connected to the **ALPHA 1-4 / 2-4 LD_{plus}** freeze-dryer according to the connection diagram. Please observe the following:

Centring rings and clamping flanges with wing nuts are used as connecting elements (small-flange connection according to ISO 28403 or DIN 2861, see the following instructions).

Instructions for the connection with centring rings and clamping flanges

Small flange connections which are not mounted properly between the aggregates or to connect hoses are often the reason for serious vacuum problems.

Loosen the connection and place the centring ring (with sealing ring inside) in a centred manner between the flange connections.. Seal the connection with the clamping ring by tightening the wing nut.

Ensure that the centring ring neither slips out of place nor gets jammed.

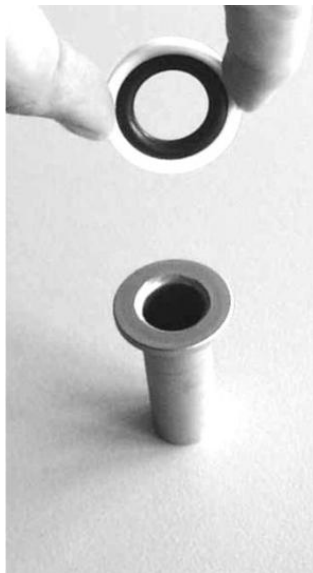

Small flange and centring ring



Small flange with centring ring and small flange



Attaching the clamping ring

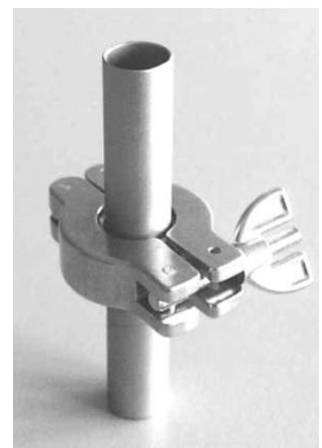

Tightened clamping ring

Installation of the VSP62/63 vacuum sensor

The vacuum sensor has to be connected to the vacuum connection at the back of the unit in an upright position using a centring ring and a clamping ring. The sensor connecting cable has to be connected to the corresponding socket at the back of the unit.

After power-on, the vacuum sensor needs a few minutes to reach its operating temperature.

Installation of the pressure control valve

In case a pressure control valve is available it has to be mounted between the freeze-drying unit and the vacuum pump. Then it has to be plugged into the socket of the freezing unit on the rear panel of the unit.

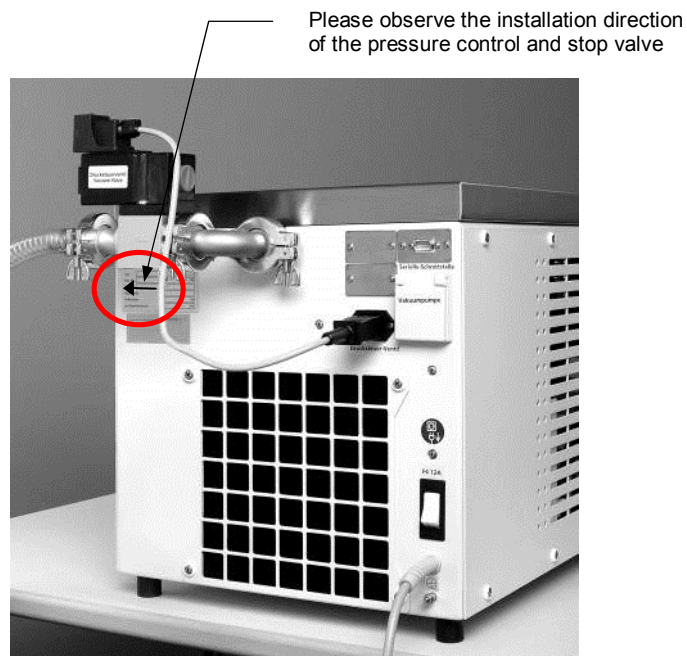

Installation of the vacuum pump

The vacuum pump is connected to the unit and plugged into the socket on the rear panel of the unit.

The vacuum gases shall be filtered or drained.

The aeration valve and the drain valve on the left side of the unit have to be closed.

The lid or the drying chamber has to be mounted to the ice condenser chamber.

In case the drying chamber is equipped with rubber valves they have to be closed.

Further accessories (e.g. shelves, connections for round bottom flasks) are added accordingly.

4.8.3. Diagram of the accessories

The other accessories (e.g. drying chamber, shelves, and connections for round bottom flasks) will be completed according to the scope of supply.

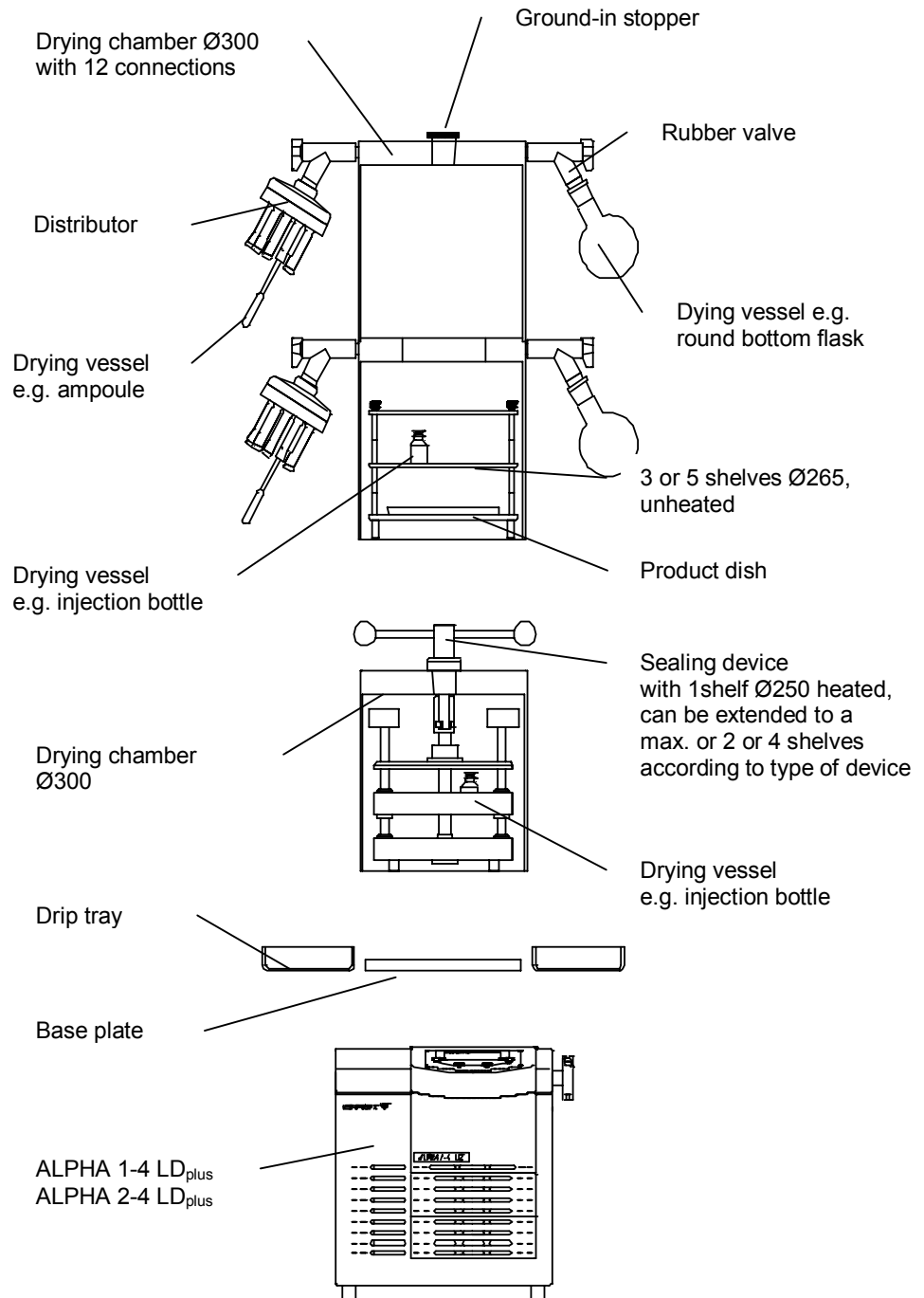

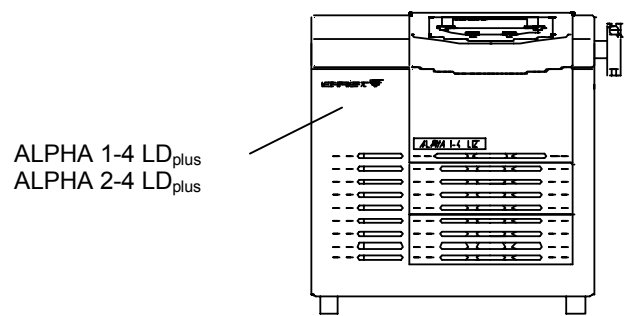
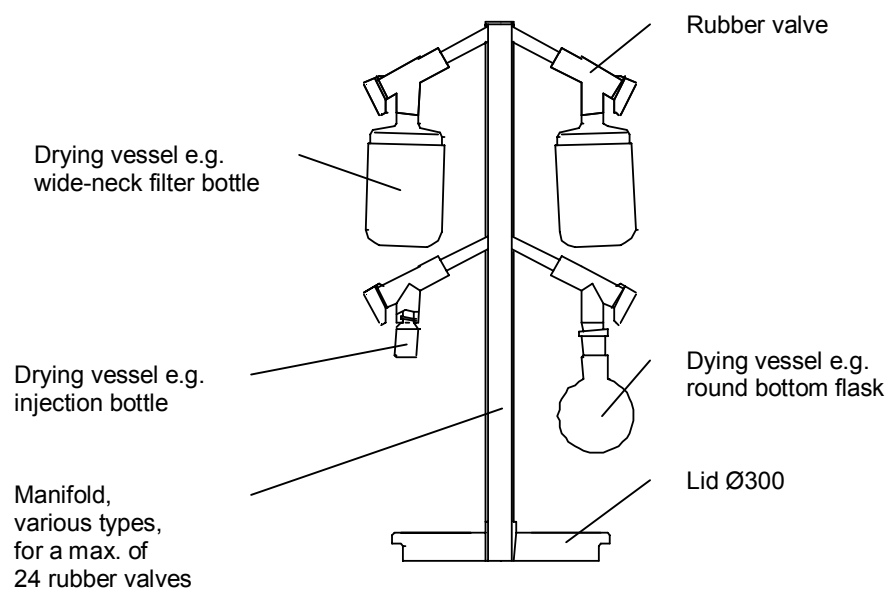

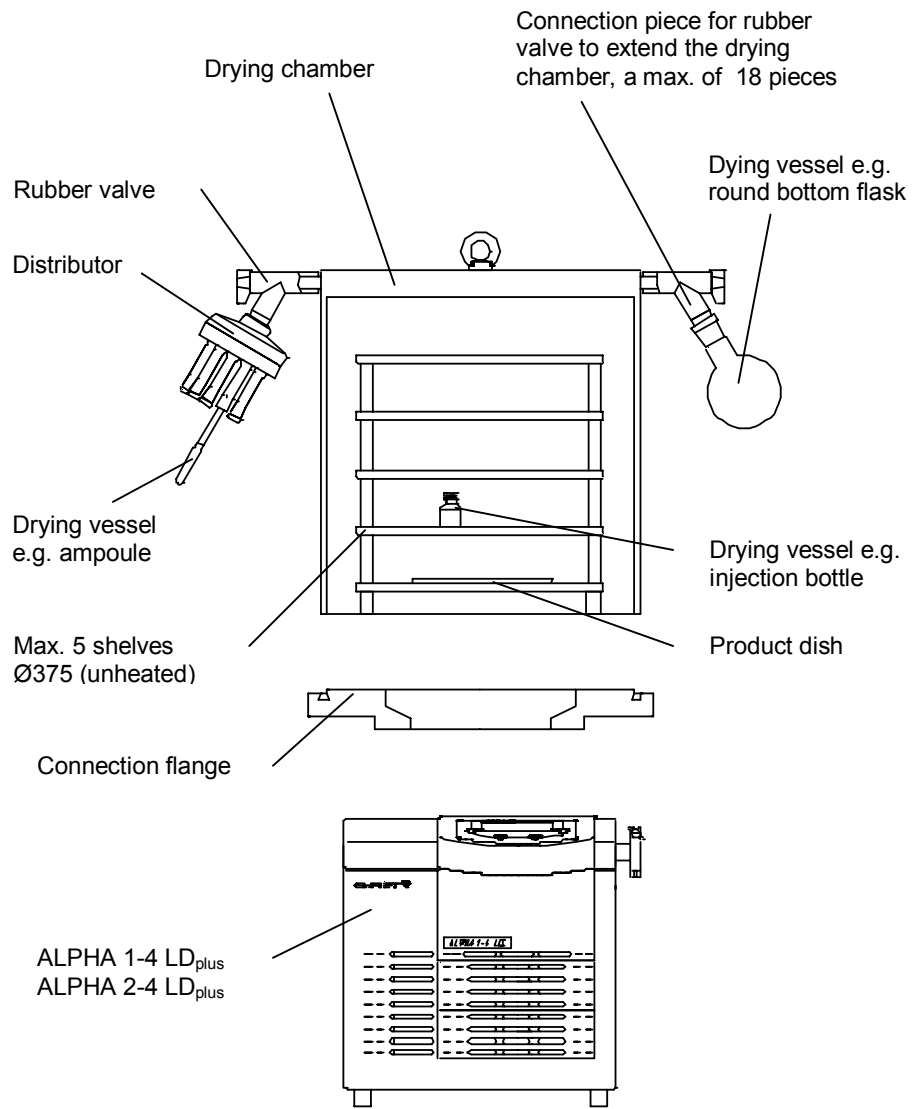

4.8.4. Rubber valves

The rubber valves (part no. 121860) enable the connection of round-bottom flasks, wide-neck filter bottles, or distributors for ampoules to a manifold or drying chamber. Depending on the connector of the components, the blue plug can be removed.

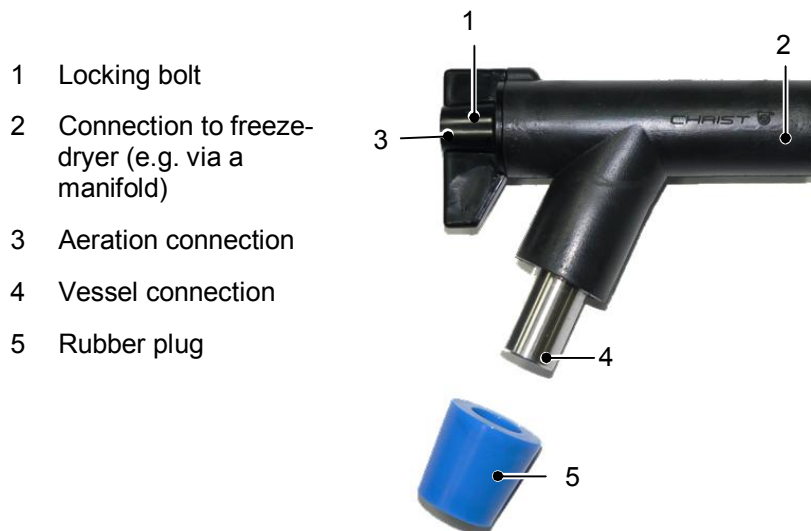

NOTE! The rubber valves come supplied in an ungreased state. This is why a thin layer of vacuum grease must be applied to the connector of the freeze-dryer as well as to the vessel connector prior to start-up in order to ensure trouble-free operation.

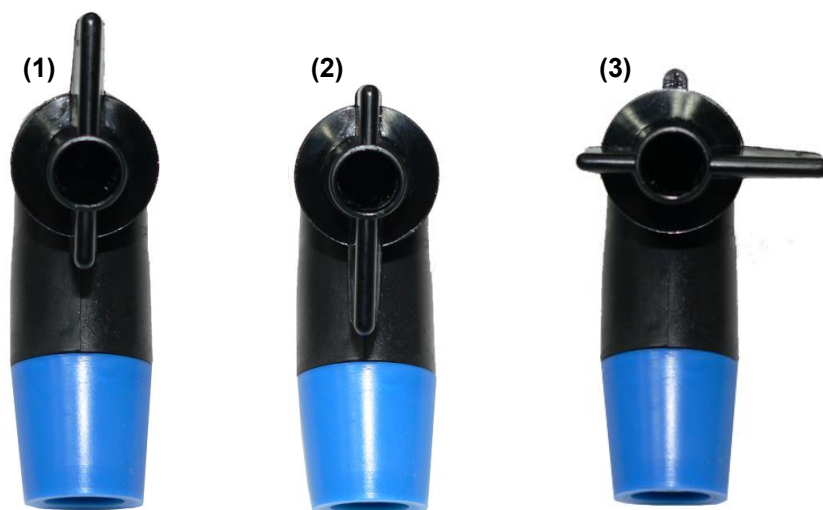

In position (1), the aeration connector is open and the vessel connector is closed. The accessory will be aerated while the vacuum inside the drying chamber is maintained. As a result, vessels can be exchanged without any interruption of the drying process.

In position (2), the aeration connector is closed and the vessel connector is open. The connected accessory is connected to the freeze-dryer.

In position (3), the aeration connector and the vessel connector are closed.

4.8.5. Switching-on

Press the mains switch on the right side of the unit to switch the unit on.

The initialization of the LD_{plus} control system starts. This may last for several seconds.



When the unit is switched on for the first time (after delivery from the factory), the user will be guided through the LD_{plus} control system in the form of a tutorial for a quick familiarisation with the unit.

First select your language using the up \uparrow and down \downarrow keys and confirm your selection by pressing the Next \blacksquare - \circ softkey.



After this, the user will be guided step by step through the tutorial.

In the end, the program inquires as to whether the user wants the tutorial to be displayed again when the unit is switched on the next time.

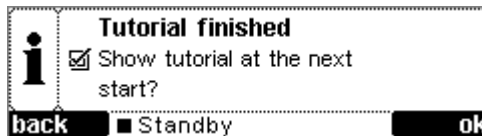

5. LDplus Control System

5.1. Introduction

LDplus (Lyo Display Plus) stands for a convenient user interface for controlling freeze-drying processes.

5.2. LDplus control panel

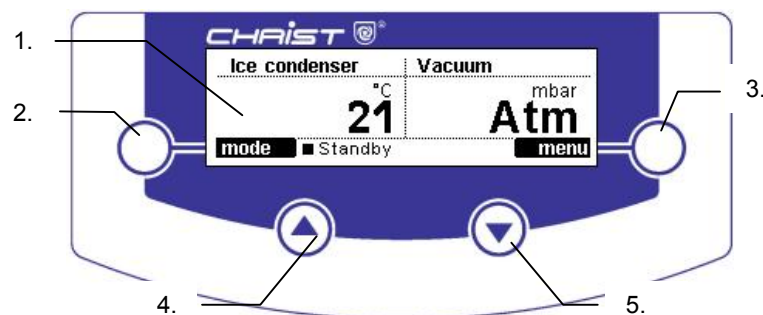

1. Illuminated LC display (240x64 pixels)
2. Left softkey ○—
3. Right softkey —○
4. “Up” key ⊕
5. “Down” key ⊖

5.3. Brief Guide - Handling

The LDplus control system is operated via four keys that are located centrally on the touch-sensitive control panel.

The following functions are assigned to the four keys ○— —○ ⊕ ⊖:

- Left softkey ○— & right softkey —○
Softkeys are keys with dynamic functions assigned to them. The current key function is displayed next to the key. Softkeys allow the control system to be operated in a particularly easy and transparent way.
- “Up” key ⊕ & “down” key ⊖
The “up” key ⊕ and the “down” key ⊖ are used to select set values and actual values to be displayed in the values window. The “up” key ⊕ is assigned to the left-hand values window and the “down” key ⊖ to the right-hand values window. If one of the keys is pressed, the system scrolls through the available set values or actual values. Inside the menu, the “up” key ⊕ and the “down” key ⊖ are used to shift the focus. When parameters are entered, they are used to change the value.

5.4. Visual components of the LDplus control system

The LC display is divided into the three following areas:

1. Main window
2. Status bar
3. Softkey function

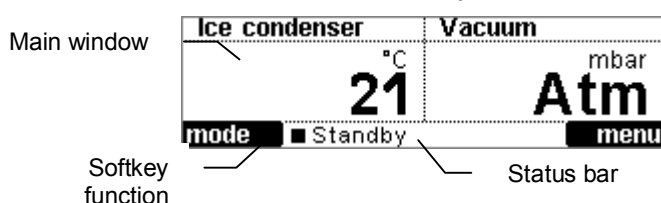

5.4.1. Main window

The main window shows set values and actual values, menus and process-relevant information.

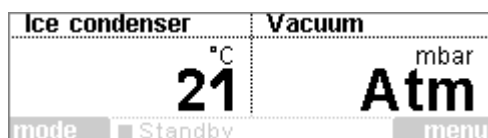

5.4.2. Status bar

The status bar shows the current operating mode, the active phase and other relevant information. The status bar is visible at all times.

Structure of the status bar:

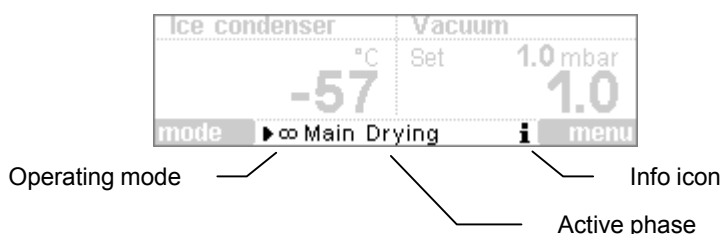

5.4.2.1. Operating mode

- ■ Standby
The freeze-dryer is in the standby mode. All aggregates are switched off.
- ▶∞
The freeze-dryer is in the run mode. The timer is deactivated.
- ▶⊕
The freeze-dryer is in the run mode. The timer is activated.

5.4.2.2. Active phase

- Freezing
The ice condenser is cooled.
- WarmUp VP
The ice condenser is cooled and the vacuum pump is activated with the pressure control valve closed. If no pressure control valve is installed, the drying chamber has to be shut off from the vacuum pump using a manual valve, for example.
- Main drying
The drying chamber is evacuated with the ice condenser being cooled. If a vacuum control system is included, the vacuum is controlled with the corresponding set value for main drying.
- Final drying
The final drying phase is only available if a vacuum control system is included. Different control parameters (set vacuum value, timer) can be defined for main drying and final drying.

5.4.2.3. Info icon

The info icon flashes every second to draw the user's attention to error messages, process messages or general information concerning the process or the unit. The message can be displayed in the process and equipment information window under `Menu -> Process & Equipment Information System`.

5.4.3. Softkey function

Softkeys are keys with dynamic functions assigned to them. The current key function is displayed in the black field next to the key.



In the screenshot, the left-hand softkey has the function `Mode` and the right-hand softkey has the function `Menu`.

5.5. Values window

The values window is displayed after the initialization of the LDplus control system. It is divided into two areas, the left-hand values window and the right-hand values window.

The left-hand and right-hand value windows are structured as follows:

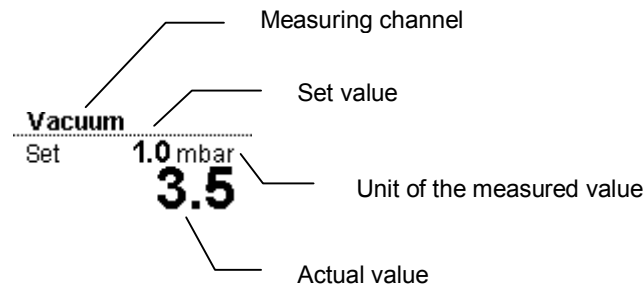



The “up” key \odot is used to select the measuring channel to be displayed in the left-hand values window. The “down” key \ominus is used to select the measuring channel in the right-hand values window.

The following measuring channels are available:

- Total time
Counts the time of the entire process run
- Section time
Counts the time of an individual phase (freezing, warm-up vacuum pump, etc.)
- Ice condenser temperature
Temperature of the ice condenser
- Vacuum in mbar
Vacuum in the drying chamber. This measuring channel can only be selected if a vacuum sensor is installed.
- Vacuum converted into °C
Vacuum in the drying chamber in °C, converted according to the vapor pressure curve above ice for water (see the chapter "General Information on Freeze-drying"). This measuring channel can only be selected if a vacuum sensor is installed.

5.6. Mode

The mode selection can be activated by pressing the left-hand softkey **Mode**  in the active values window. The function **Mode**  includes the operating mode selection and the phase selection.



Freeze-drying comprises the following four phases:

- Freezing
- Warm-up vacuum pump
- Main drying
- Final drying

5.6.1. Starting a drying process

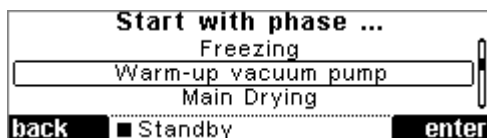
If the unit is in standby mode, pressing the softkey **Mode**  leads to an inquiry concerning the phase to be used for starting the freeze-drying process.



If the user wants to start directly with the main or final drying phase, the system inquires as to whether the vacuum pump should be warmed up. This inquiry has to be confirmed by pressing either **yes**  or **no** .

5.6.2. Changing the phase

If the unit is in the run mode, you can change over to the next phase or stop the process by selecting “Standby”.

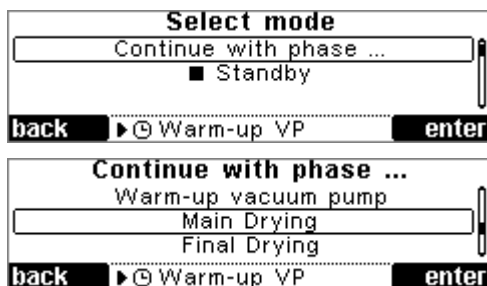

5.6.3. Timer

If the timer is active for the phase (timer set value \geq 1 minute), the system inquires before the selected time is over as to whether the user wants to continue with the next phase.

If the last phase is active, the system inquires as to whether the process should be continued or stopped (standby).

To deactivate the timer, select an infinite set value (∞).

As an option, it is possible to change over to the next phase automatically when the preselected time is over.



This applies only to a phase change from:
 Freezing ⇌ Warm-up vacuum pump
 Main drying ⇌ Final drying

The option can be activated under Menu -> Options -> Settings -> Automatic phase change.

5.7. Main menu

The main menu can be activated by pressing the right-hand softkey Menu in the active values window.

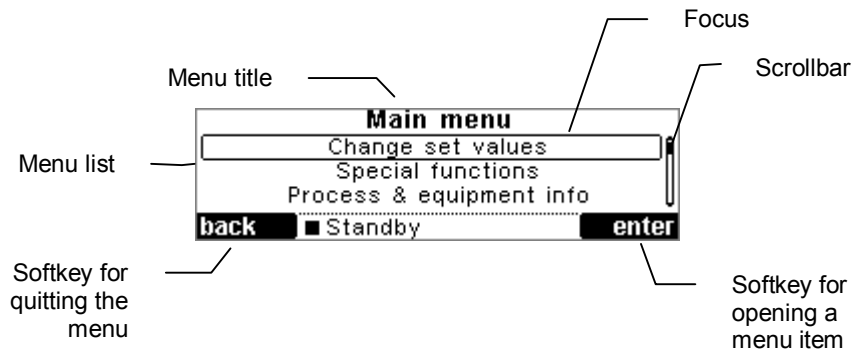

The following section explains all menu items in detail:

5.7.1. Change set values

Used to define the phases “freezing”, “main drying” and “final drying”.

First select the phase.

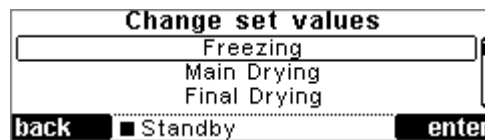

Select the set value using the focus.

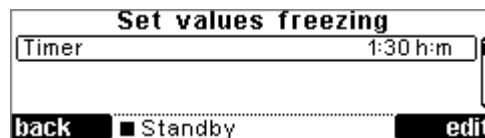

Press the right-hand softkey Edit to start the editing mode. The focus is displayed in an inverted manner. You can now change the set value within a permissible range using the “up” and “down” keys.

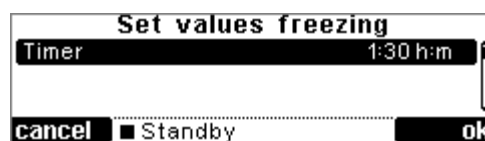

Press OK to confirm the set value or Cancel to reject it. The editing mode is quit.

5.7.1.1. Set values for freezing

- **Timer**
Time for the freezing phase section time. You can set a time between 1 minute and 200 hours. Selecting the infinite set value (∞) deactivates the timer for the freezing phase.

5.7.1.2. Set values for main drying & final drying

- **Timer**
Time for the main or final drying phase section time. You can set a time between 1 minute and 200 hours. Selecting the infinite set value (∞) deactivates the timer for the main or final drying phase.
- **Vacuum**
Set value for the control vacuum in the drying chamber during main or final drying. The vacuum control option must be installed. You can set a value between 6.1 mbar and 0.0010 mbar converted into steps of 1°C according to the vapor pressure curve above ice for water.

Set values for final drying are not available unless the vacuum control option is installed.

5.7.2. Special functions

The special functions menu is used to operate special accessories (defrosting device and electrical lifting device) of the freeze-dryer.

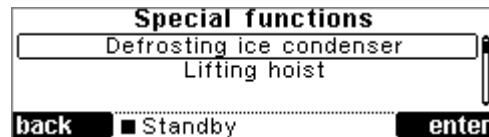

If one of the options is not installed in the freeze-dryer, the system displays the message `Option not available`.

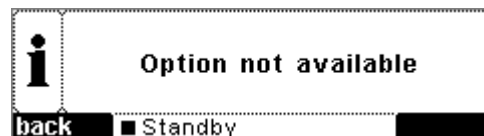

A detailed description of the special functions can be found in the chapter "LDplus Special Functions".

5.7.3. Process and equipment information system

Further information can be found in the chapter "Process and equipment information system".

5.7.4. Options

The Options menu includes the functions Contrast, Language, Settings and Service.



5.7.4.1. Contrast

The Contrast menu is used to change the contrast of the LC display. The contrast has to be adapted to the local light conditions at the installation site of the freeze-dryer.

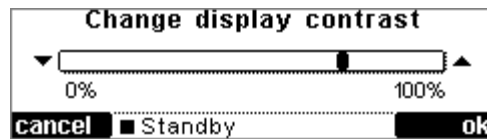

5.7.4.2. Language

The LDplus control system can be used in the German, English, French, Spanish, Polish or Russian language.



5.7.4.3. Settings

The Settings menu is used to customize the operation and process management of the control system.

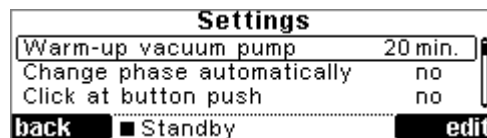

Warm-up vacuum pump

Warm-up time required by the vacuum pump. In case of doubt, please refer to the operating manual of the vacuum pump. You can set a warm-up time between 5 and 60 minutes.

Automatic phase change

The system automatically continues with the next phase when the preselected time is over (timer active).



This applies only to a phase change from:

- Freezing → Warm-up vacuum pump
- Main drying → Final drying

Click upon key depression

A brief sound signal can be heard whenever a key is pressed.

High temperature resolution

Temperatures are displayed in the values window with a resolution of $\frac{1}{10}^{\circ}\text{C}$, normally with a resolution of 1°C .

Time Defrosting

Input of the time that is required for defrosting the ice condenser.

Temperature Defrosting

Input of the maximum temperature of the chamber or ice condenser during the defrosting phase.

5.7.4.4. Service menu



The settings of the service menu should only be modified by authorised persons in order to ensure the trouble-free operation of the freeze-dryer!

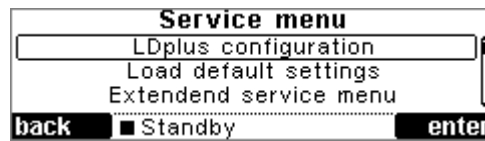

LDplus configuration

Configuration of accessories (options). If an option is installed, it has to be activated with "yes". If the option is not installed, it has to be deactivated with "no".

Possible options:

- Vacuum sensor
- Vacuum control system

Load default settings

All set values and parameters are reset to the delivery status of the unit.

Extended service menu

The extended service menu is reserved for service engineers only.

This area is password-protected and not available to the user.



5.7.5. Tutorial

Starts the tutorial of the LDplus control system (available only in German, English or French).



5.8. Process and equipment information system



A detailed list of error messages can be found in the chapter "Error Correction".

The process & equipment information window is displayed whenever the LDplus control system generates a new information message. In addition, the user can select `Menu -> Process & Equipment Information System` in the main menu to check whether messages are pending.

If no messages are pending, the following window is displayed.

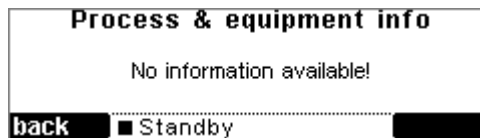

When a message is generated, a signal can be heard, the information icon **i** appears on the status bar and the process & equipment information window is displayed. If the user is working in a menu, the process & equipment information window will not be displayed until the user quits the main menu.

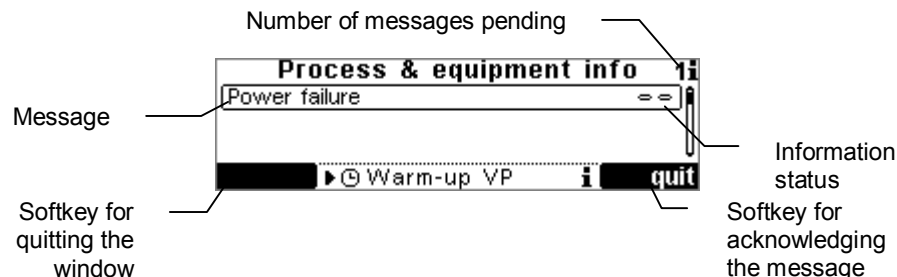

5.8.1. Information status

Every piece of information shown in the process & equipment information window receives a certain status.

- **⊗** = Information present, not acknowledged
- **⊗ ✓** = Information present, acknowledged
- **=** = Information no longer present, not acknowledged

Once a piece of information is no longer present but has been acknowledged, the information will be removed from the process & equipment information window.

The signal continues until all pieces of information are acknowledged.

In order to quit the process & equipment information window, you have to acknowledge all pieces of information so that the softkey `Back` **○** can be displayed.

5.9. LDplus special functions

5.9.1. Defrosting the ice condenser

Depending on the equipment variant, the freeze-dryer can be equipped with a defrosting device. If the system is defrosted with a defrosting device, heat is supplied to the ice condenser chamber in order to melt the ice that has built up on the ice condenser.

Enter the required time for defrosting under `Menu -> Options -> Time Defrosting`.

Enter the maximum temperature of the chamber or ice condenser during defrosting under `Menu -> Options -> Temperature Defrosting`.

Open the menu `Menu -> Special functions -> Defrosting ice condenser`.



In order to defrost the ice condenser, the unit must be in the standby mode and completely aerated. Defrosting should be performed without a lid on the chamber in order to prevent the system from shutting down due to overheating.

Press the right-hand softkey `Start`  to start the defrosting process. The following window is displayed. It shows the progress of the defrosting process.

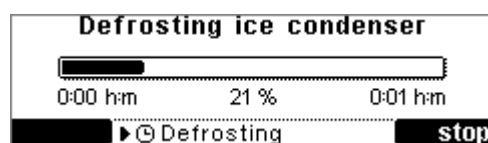

The illustration varies depending on the equipment variant.

When the defrosting time is over, the defrosting process is stopped and the window is closed.

You can set the time required for defrosting under `Menu -> Options -> Settings -> Defrost ice condenser`.

5.9.2. Electrical lifting device (option)

To move the drying chamber with the help of the electrical lifting device, open the menu `Menu -> Special functions -> Electrical lifting device`.



In order to move the drying chamber, the unit must be completely aerated. It is not possible to move the drying chamber during main drying or final drying.

Use the “up”  and “down”  keys to move the drying chamber.



6. Error Correction

6.1. Power Failure

The control system continues the process after a power failure. The preselected conditions remain saved during the process run. The process times, the total time and the section time are reset.

In the event of a power failure during the drying process the batch may become unusable. Whether the batch can be saved depends on the drying phase in which the product was when the power failure occurred.

It is important to distinguish between the main drying and final drying phase:

The product is in the final drying phase when the residual moisture has reached approx. 5 %. Below this value the product is generally not damaged in the event of a power failure.

If the product is in the main drying phase we recommend that the unit is vented, the product taken out and stored in a deep-freeze. Before further operation the defrosted condensate must be drained.

6.2. Insufficient Vacuum

Special attention must be paid to the high-vacuum valves. The drain valve, the micro-aeration valve and the rubber valves must be checked.

We recommend that after disconnecting the mains plug the left side panel of the unit is unscrewed and then the hose inside the unit is detached from the drain valve, the pipe connection is sealed with a rubber stopper, and the unit evacuated. If the unit will now reach the necessary operating pressure there is a leakage in the valve. This is caused by residue from the drying process, fluff from cleaning cloths or wear and tear of the O-rings of the valve.

To eliminate this fault we recommend that the unit is evacuated and vented by means of the drain valve so that any residue (e.g. collected parts) is removed. If necessary, the O-rings must be replaced.

If the leakage cannot be eliminated in this way, the drain valve must be cleaned or replaced.

Check the sealing of the lid for dirt or damages. If necessary, the sealing must be cleaned or replaced.

Check if the whole surface of the ground-in socket of the mountable drying chamber has been greased evenly and completely with vacuum grease.

When using drying chambers with several connections for rubber valves the valves should be taken off and the connections should be sealed with rubber stoppers. To check the valves they are connected one after the other and tested under vacuum.

Check the vacuum sensor for pollution such as water residue.

The vacuum sensor has a limited life time due to its design principle (see also chapter 7.3.1). Vacuum sensors are available as a spare part.

Check the vacuum display with a suitable testing unit (if available).

In order to locate a possible leak we recommend that the vacuum measuring sensor is directly connected to the vacuum flange of the vacuum pump. If the warm vacuum pump reaches a final pressure of at least 0.011 mbar, the vacuum pump and the measuring system can be presumed to be in working order. There is probably a leak in the unit if insufficient vacuum is not caused by an insufficient ice condenser temperature.

Check the oil level in the vacuum pump, change oil if dirty, and carry out a pressure test.

If the above-mentioned steps show no result, the next step is to check all small flange connections (see chapter 4.7.2) and especially the position of the centring rings. It is usually not necessary to grease the sealing rings with high vacuum grease.

The vacuum pump does not switch on:

The vacuum pump is equipped with a protective switch for the drive motor.

Please refer to separate operating manual.

General information:

The vacuum checks should be carried out when the ice condenser is deep-frozen.

6.3. Unit does not function

If the display does not work after operating the mains switch, the following must be checked:

Is the mains switch plugged in?

- Check the on site fuses.
- Check the automatic circuit breaker 1F1 on the back of the unit.

6.4. Insufficient Ice Condenser Temperature

The refrigerator is equipped with a protection device against overpressure in the refrigerating system and with a thermal motor protection.

The protection devices are released

- with too high ambient temperatures,
- with insufficient air circulation of the heat exchanger of the refrigerating system,
- with overload of the refrigerating system.

The refrigerating system is switched off automatically.

Once the permissible operating conditions are reached again (after a few minutes), the refrigerator is switched on automatically via the motor protection switch or via the pressure protection device.

Important errors are shown in the process and equipment information system.

The minimum ice condenser temperature of approx. -55°C respectively -85°C is reached if the ice condenser is not loaded and the ice condenser chamber is evacuated.

Sufficient air circulation is necessary. Do not deposit any objects behind the freezing unit!

6.5. Process and Equipment Information System

6.5.1. Error Messages

Vacuum of 6.11 mbar has not been reached
<p>This error occurs in case the pressure in the ice condenser chamber has not reached 6.11 mbar after 15 minutes of operation with open pressure control valve. There must be a vacuum leak in the system. The pump is switched off to avoid it pumping against the atmospheric pressure.</p> <p>The pressure control valve is closed and the vacuum pump is switched off. Please eliminate the error and confirm the message afterwards. Following the confirmation, the vacuum pump is restarted.</p> <p>Causes:</p> <p>Micro-aeration valve or drain valve not closed.</p> <p>Lid or drying chamber not mounted correctly.</p> <p>Missing ground-in stopper in the lid or in the drying chamber.</p> <p>Defective vacuum pump. Check whether the mains switch of the vacuum pump is switched on.</p>

Vacuum sensor defective
<p>This error message is displayed in case the unit control system reads in an invalid value supplied by the vacuum sensor.</p> <p>Check the connecting cable and the connections to the vacuum sensor, perform an atmospheric adjustment of the sensor or replace the vacuum sensor if necessary.</p> <p>Causes: Vacuum sensor not connected. Heating spiral of vacuum sensor broken.</p>
Overpressure refrigerator 1
<p>Overpressure in refrigeration unit KM1, released via the pressure switch.</p> <p>Please check the ambient temperature, ensure sufficient air circulation of the heat exchanger of the refrigeration system and check the load of the unit.</p>
Overpressure refrigerator 2
<p>Overpressure in refrigeration unit KM2, released via the pressure switch.</p> <p>Please check the ambient temperature, ensure sufficient air circulation of the heat exchanger of the refrigeration system and check the load of the unit.</p>
Excess temperature "ice condenser"
<p>This error occurs in case the temperature of the ice condenser exceeds +65°C. All active aggregates are switched off simultaneously, i.e. the system is automatically switched to standby mode. The error message can occur when the temperature of the ice condenser exceeds +65°C when defrosting the system. The refrigerating unit is switched off in order to prevent it from being operated or started at too high temperatures. The system cannot be restarted until the ice condenser temperature is lower than +65°C.</p>
Ice condenser temperature $\geq -20^{\circ}\text{C}$
<p>In the case of insufficient ice condenser cooling, the ice condenser temperature can increase to $\geq -20^{\circ}\text{C}$ during the drying process. In order to avoid damage to the vacuum pump caused by the withdrawal of condensable gases, the pressure control valve will close automatically when reaching this temperature, and an error message is displayed. Please observe the function of the refrigeration system and contact the service department, if necessary.</p>
Temperature sensor "ice condenser" defective
<p>This error occurs in case the temperature sensor is not connected properly or in case it is defective. Please contact our service department.</p>
Temperature sensor "defrosting heater" defective
<p>This error occurs in case the temperature sensor is not connected properly or in case it is defective. Please contact our service department.</p>
Mains failure
<p>The system detects a mains failure when the power supply is interrupted under operating conditions (run mode). Once power supply is re-established, the process will be continued. Process times will be reset to zero. Set values for control purposes remain unaffected.</p>
Factory settings loaded
<p>All settings are reset to the delivery status of the unit. The factory settings are loaded in case the corresponding command is executed in the service menu or in case of an error in the parameter memory.</p>
IO communication error (0x20)
<p>Error in the IO module LDplus EA Please contact our service department.</p>

7. Maintenance and Service

7.1. Maintenance

7.1.1. Ice Condenser Chamber

Before each start-up ensure that all water residue has been removed from the ice condenser chamber. If necessary, wipe the ice condenser chamber.

Before every drying process it is recommended to open and close the drain valve once.

7.1.2. Heat Exchanger

A laminated heat exchanger is used to cool the refrigerant compressed by the refrigerator. The heat exchanger is placed at the back of the unit. In intervals of a few months it must be checked for dust or dirt residues and cleaned if necessary. Cleaning of the heat exchanger can be carried out best by brushing, by using a vacuum cleaner from the outside or by using compressed air from inside the unit.

Excessive dirt on the heat exchanger leads to a decrease in performance and can lead to a failure of the unit!

Please note: The unit must not be turned upside down!

7.1.3. Vacuum Sensor VSP62/63

Please refer to the separate operating manual of the vacuum sensor VSP62/63!

The VSP62/63 vacuum sensor is equipped with an internal Pirani sensor, which utilises the thermal conductivity of gases. The tungsten wire reacts with the components of the ambient gas, which is why it only has a limited service life. Carbon-containing substances, such as alcohol compounds in particular, extremely reduce the service life.

The vacuum sensor is maintenance-free.

Remove any soiling on the outside with a cloth.

7.1.4. Rubber Valves

Special attention must be paid to the rubber valves. If the valves are stiff, they must be dismantled, cleaned, slightly greased with vacuum grease and reassembled.

7.1.5. Vacuum Pump

For maintenance of the vacuum pump please refer to the separate operating manual.

Additionally, we would like to emphasise the following points:

The oil level of the vacuum pump must be regularly checked using the inspection glass (in case of continuous operation at least once a week). Top up oil to the required level via the oil inlet. For topping-up see the operating manual of the pump.

The first oil change must be carried out after approx. 100 operating hours. Subsequent oil change intervals depend on the operating conditions. In general, an oil change is necessary after approx. 500 to 1000 operating hours.

The oil change should always be carried out with warm pump.

7.1.6. Exhaust Filter

If the unit is equipped with an exhaust filter (necessary if the exhaust gases cannot be extracted into the open air or into a vent) take care that the condensate in the filter does not rise too high. The condensate is drained using a waste oil drain screw at the filter.

Please refer to separate operating manual!

7.1.7. Cleaning

7.1.7.1. *Cleaning of the Freeze-dryer*

Use soap water or other water-soluble, mild agents for cleaning of the freeze-dryer. Avoid corrosive and aggressive substances. Do not use alkaline solutions or solvents or agents with abrasive particles. Remove product residues from the ice condenser chamber using a cloth. It is recommended that the lid to the freeze-dryer or drying chamber is left open when the freeze-dryer is not in use so that moisture can evaporate.



If there is the risk of toxic, radioactive or pathogenic contamination, special safety measures must be considered and adhered to.

7.1.7.2. *Cleaning of Accessories*

When looking after accessories special safety measures must be considered as these are measures to ensure operational safety and reliability.

Chemical reactions as well as stress corrosion cracking (combination of changing pressure and chemical reaction) can affect or destroy the structure of the metals and plastic parts. Hardly detectable cracks on the surface expand and weaken the material without visible signs. When visible damage of the surface, a crack,

a mark or any other change, as well as corrosion is detected, the part in question (shelf, vessel, drying chamber etc.) must be replaced immediately for safety reasons.

Fans, lid seal, vessels, racks, drying chamber and shelves must be cleaned regularly in order to avoid damage.

Cleaning of accessories should be carried out away from the freeze-dryer once a week or preferably after every use.



If there is the risk of toxic, radioactive or pathogenic contamination, special safety measures must be considered and adhered to.

Aluminium accessories are particularly subject to corrosion. A neutral agent with a pH-value between 6 and 8 should be used for such parts. Alkaline agents (pH > 8) must be avoided. Thus life time is increased and corrosion is reduced considerably.

Careful maintenance through the user increases life time and avoids premature failure of accessories. Damage caused by insufficient care does not constitute a warranty claim.

7.1.7.3. Maintenance of the Drying Chamber

The drying chamber is equipped with the LYO CHAMBER GUARD splinter protection film. In order to prevent the film from being damaged, only use water and commercially available window cleaning agents as well as synthetic sponges, soft tissues or a rubber wiper for cleaning.

Do not use any scouring agents, hard sponges, rough tissues, or brushes!

Do not dry-clean any drying chambers that are equipped with LYO CHAMBER GUARD film!

7.1.7.4. Maintenance of the Aeration Valve and the Drain Valve

Special attention must be paid to the aeration valve and the drain valve. If residues from previous drying processes deposit on them, there is the risk of faulty operation of the freeze-dryer. Therefore, take care that no product or other residues will get into the pipe to the aeration valve and the drain valve.

7.1.8. Disinfection of Drying Chamber, Lid and Accessories

All usual disinfectants like e. g. INCIDUR, Melisiptol, Sagrotan, Buraton or Terralin (available at laboratory retail suppliers) can be used.

NOTE! Check compatibility with lid and drying chamber; also see enclosure "Resistance to stress cracking and chemical influences PLEXIGLAS®" (acrylic glass).

The freeze-dryers and the accessories consist of different materials. A possible incompatibility must be considered. The compability of the outer protective layer of the LYO CHAMBER GUARD film has not been field-tested yet. Therefore, we cannot guarantee a compability of 100% with disinfectants.

For autoclaving the temperature stability of the individual material must be checked. Please consult us if in doubt.

If dangerous materials are used, the freeze-dryer and the accessories must be disinfected.

7.1.9. Checks by Operator

The operator has to ensure that the important parts of the freeze-dryer relevant for safety are not damaged.

This especially refers to:

- Lid or drying chamber
- Seals
- Oil level of vacuum pump
- Accessories, especially changes like corrosion, wear and tear of material etc.

Furthermore, an earth conductor check must be carried out regularly.

7.2. Service



DANGER! In the event of service work that requires the removal of the panels, there is a risk of electric shock or mechanical injury. Only qualified specialist personnel is authorised to perform this service work.

The freeze-dryer is subject to high mechanical stress. In order to be able to withstand this high level of stress, high-quality components were used during the production of the freeze-dryer. Nevertheless, wear cannot be excluded and it may not be visible from the outside.

This is why we recommend having the freeze-dryer checked by the manufacturer during an inspection once per year.

Information and appointments:

in Germany:

use the service request form at
www.martinchrist.de → [Service Area]

or contact

Martin Christ Gefriertrocknungsanlagen GmbH
An der Unteren Söse 50
37520 Osterode (Germany)
Phone +49 (0) 55 22 / 50 07-84 25
Fax +49 (0) 55 22 / 50 07-94 25
E-mail: service@martinchrist.de

outside Germany:

contact our agency in your country. All agencies are listed at
www.martinchrist.de → [Contacts] → [Foreign agencies]

NOTE!

- If you would like to utilise our service, please state the type of your freeze-dryer and its serial number
- Make use of our service request on the Internet. Please use the request form (see above) on our website.

7.3. Return of defective parts

Although we exercise great care during the production of our products, it may be necessary to return a unit or accessory to the manufacturer.

In order to ensure the quick and economical processing of returns of freeze-dryers, rotational vacuum concentrators, spare parts, or accessories, we require complete and extensive information concerning the process. Please fill in the following forms completely, sign them, enclose them with the return package, and send them together with the product to:

Martin Christ Gefriertrocknungsanlagen GmbH
An der Unteren Söse 50
37520 Osterode (Germany)

1. Declaration of decontamination

As a certified company and due to the legal regulations for the protection of our employees and of the environment, we are obliged to certify the harmlessness of all incoming goods. For this purpose, we require a declaration of decontamination.

- The form must be filled in completely and signed by authorised and specialised personnel only.
- Affix the original form in a clearly visible manner to the outside of the packaging.

NOTE! If no such declaration is enclosed in the return package, we will perform the decontamination at your expense!

2. Form for the return of defective parts

This form is for the product-related data. They facilitate the assignment, and they enable the quick processing of the return. If several parts are returned together in one packaging, please enclose a separate problem description for every defective part.

- A detailed problem description is necessary in order to perform the repair quickly and economically.
- Please note on the form if you would like to receive a cost estimate. Cost estimates are only prepared upon request and against charge. If an order is placed, these charges will be offset.

NOTE! The unit must be packaged in a transport-safe manner. Please use the original packaging, if at all possible.

If the product is dispatched to us in unsuitable packaging, you will be charged the cost for returning it to you in new packaging.

The forms can be downloaded online from www.martinchrist.de → [Service Area].

8. Options

8.1. Process Control System LPC-32, Software

Upon request.

See separate operating manual.

8.2. Process Control System LPC-32, Software with PC hardware

Upon request.

See separate operating manual.

8.3. LyoLog LL-1 (Documentation Software)

Upon request.

See separate operating manual.

8.4. LDplus Simulation Tool (Training Software)

Upon request.

8.5. Electrical lifting device

Only for ALPHA 1-4/2-4 LSC GAMMA 1-16 LSC / 2-16 LSC and DELTA 1-24 LSC / 2-24 LSC ALPHA 1-4/2-4 LDplus BETA 1-8/2-8LDplus

9. Enclosures

Declaration of conformity ALPHA1-4 LDplus / ALPHA 2-4 LDplus

Safety data sheet "Resistance to stress cracking and chemical influences PLEXIGLAS®"
(material of the drying chamber and the lid)

Operating manual of the vacuum pump (only in case of delivery)

Operating manual of the exhaust filter (only in case of delivery)

Operating manual of the vacuum sensor (only in case of delivery)

EC – DECLARATION OF CONFORMITY

in accordance with the EC Machinery Directive 2006/42/EC, annex II, part 1, section A

The product named hereinafter was developed, designed, and manufactured in compliance with the relevant, fundamental safety and health requirements of the listed EC directives. In the event of modifications that were not authorised by us or if the product is used in a manner that is not in line with the intended purpose, this declaration will be rendered void.

<i>Product name:</i>	Freeze-dryer
<i>Product type:</i>	Alpha 1-4 LDplus Alpha 2-4 LDplus
<i>Order number:</i>	101541 101542
<i>Directives:</i>	2006/42/EG Machinery Directive 2006/95/EG Low Voltage Directive 2004/108/EG EMC Directive

Martin Christ Gefriertrocknungsanlagen GmbH

An der Unteren Söse 50
37520 Osterode
Germany

CE - Authorised Representative
S. Krippendorff

Osterode, 03.08.2011



M. Christ – Management

Resistance to stress cracking and chemical influences

PLEXIGLAS® GS

PLEXIGLAS® XT

PLEXIGLAS RESIST® XT

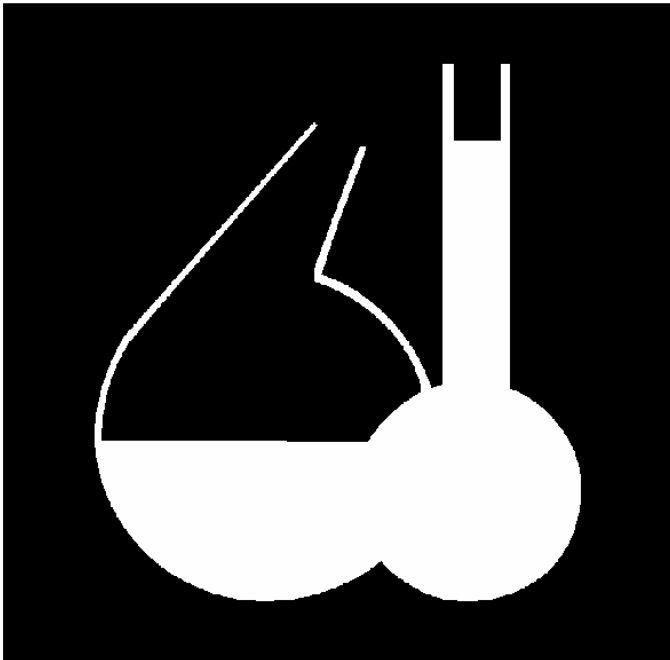

Contents

This brochure provides a summary of the chemical behavior of our semifinished product groups by listing the chemical substances tested on these materials with the aim of assessing their resistance to stress cracking (crazing) and chemical attack.

Remarks

Brief remarks on the resistance to chemicals other than those listed here, some of them branded products, are made in our leaflet entitled "Chemical resistance of PLEXIGLAS® GS and XT" (Ref. No. 211-1).

The physical properties are described in our Product Description leaflets which your stockist holds available for each group of semifinished material.

When using our products you are advised to observe

- the regional Building Regulations and emission laws,
- the applicable standards
- the product liability to VOB (= Contracting rules for award of public works contracts) and BGB (= Civil Code)
- the guidelines of the employers' liability insurance association and others.

Please consult our current sales ranges to see which semifinished products are available in the market.

Contents	Page
1 Introduction 1.1 Chemical resistance 1.2 Resistance to crazing	(varies according to computer and printer settings)
2 Test results 2.1 Explanation of symbols 2.2 Listing of results	

1 Introduction

On many occasions, the first question to be asked before choosing PLEXIGLAS® for a particular purpose is whether they are resistant to specific substances or materials. The answer to this question then decides on their use or non-use.

This is normally tested under standard conditions in the laboratory, on the one hand to evaluate the effect of different agents and, on the other hand, to compare the effect of these on different plastics, e.g. PLEXIGLAS®.

1.1 Chemical resistance

The simplest method for investigating such effects consists in bringing the substance concerned into contact with a specimen without applying any additional load, i.e. by immersing the specimen in a liquid or placing a solid substance on its surface. In this context we speak of testing chemical resistance or insensitivity to staining.

Assessment criteria are the changes in appearance, weight and strength after storage. Exposure period, temperature and concentration of the substance in contact with the material have a pronounced influence on results. In order to obtain reliable information, one would have to simulate the conditions in practical use - time, temperature and concentration - most accurately. This effort, however, is only justified in exceptional cases. In order to reduce test periods to a minimum, we increase the test temperature and/or the concentration. In doing so, we rely on our experience that chemical reactions are accelerated at increasing temperatures.

Tests of this type are described in German standard DIN 53 476, 'Determination of the behavior towards liquids' (Fig. 1).

A test period between 1 day, 1 week and 1 month is stated as the time span within which the first changes became visible in the specimen. Short-term testing within 1 minute is performed to identify particularly aggressive substances.

Different types of PLEXIGLAS® show certain variations in chemical resistance. Owing to its increased molecular weight, PLEXIGLAS® GS is somewhat more resistant than PLEXIGLAS® XT or items injection-moulded from PLEXIGLAS® moulding compound. This difference, however, is often very slight, so that the resistance lists for these materials are largely identical.

For more precise information on the chemical resistance of the different grades of PLEXIGLAS® see "2.1 Explanation of symbols."

The test results for chemical resistance apply in particular to permanent exposure of stress-free plastics to the agents mentioned.

Fig. 1: Testing of the chemical resistance to DIN 53 476

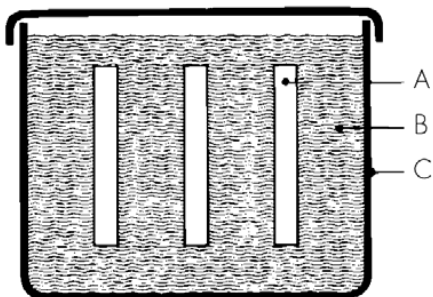

A = specimen
B = agent
C = container

1.2 Stress cracking (crazing)

Stress provoked by machining, for example, by thermoforming, screwed fastening, riveting, cold curving or local variations in thermal load, must be allowed for in many fields of application. This stress has to be taken into account when evaluating the behavior of PLEXIGLAS®.

Where plastics exposed to air are stressed or strained beyond a specific limit, they will sooner (high stress/strain) or later (low stress/strain) develop crazes. Simultaneous exposure to certain agents may drastically reduce the time span up to the onset of crazing. This phenomenon is termed "environmental stress cracking" or just "crazing."

As can be shown by a simple test, only tensile stress causes cracking: if we bend a PLEXIGLAS® rod between our hands (Fig. 2) and moisten the stressed convex surface with ethyl alcohol, cracks develop within a short time. The same test on the concave lower surface subjected to compressive stress does not cause crazing even after a long time.

PLEXIGLAS® lends itself to various crazing tests, all of them being fairly demanding as far as the preparation and number of specimens, test procedures and testing equipment are concerned.

A further difficulty consists in transferring test results to practical conditions, since many users do not have the necessary experience.

A much simpler test method, the so-called "**bending test**," has been successfully used in our company for over 30 years. The stress conditions it simulates are between those of the tensile creep test and the bending strip method according to DIN 53 499.

The surface of a horizontal test bar, which is held on one side only (Fig. 3), is coated with the test medium and loaded at its free end in such a way that a tensile stress $\sigma_{b,m}$ of no more than 30 MPa is generated near the clamping device. This value decreases linearly towards the loaded end, where it reaches zero. A defined tensile stress is assigned to each point along the surface of the test bar. Crazing sets in at the point of maximum tensile stress and progresses within the test period towards the loaded end, up to a certain point. After a test period of 24 hours at a temperature of 23 °C, the bar is visually inspected for crack propagation. A flexural stress at conventional deflection $\sigma_{b,g}$ is calculated for the end point of crazing.

Long-term experience has shown that products which do not develop crazes after 24 hours at a flexural stress of over 25 MPa and a temperature of 23 °C (and/or at over 15 MPa and a temperature of 50 °C) are not prone to stress cracking in practical use, provided our handling instructions are duly observed.

Fig. 2: Manual test of stress cracking

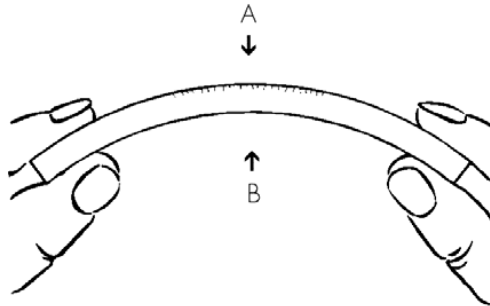

A = tensile stress
B = compressive stress

Fig. 3: Bending test of stress cracking

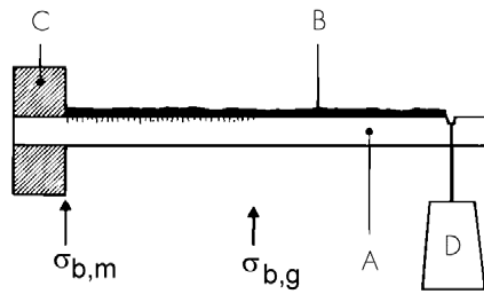

A = specimen
B = agent
C = clamping device
D = load

2 Test results

2.1 Explanation of symbols

With the results stated in the subsequent lists we use symbols and abbreviations that are in need of explanation:

conc =	concentration of the test medium at maximum possible chemical purity or in aqueous solution
mat =	material, i.e. type of semifinished product, from which the test specimens were obtained
233 =	PLEXIGLAS® GS 233; results also valid for GS 215, 218, 221, 222, 231, 238, 1001, 2458 and PLEXIGLAS SOUNDSTOP® GS. Cross-linked, PLEXIGLAS®, e.g. GS 209 and GS SW 235 (sanitary ware grade) shows much higher resistance
XT =	PLEXIGLAS® XT 20070; results also valid for XT 20080, 24370, 21570 AR, MIRROR XT and PLEXIGLAS SOUNDSTOP® XT

XT-R =	PLEXIGLAS RESIST® XT 41; results also valid for RESIST XT 31 and RESIST XT 21. All RESIST XT grades are more sensitive to chemicals but less prone to crazing than non-modified XT grades.
	Colored PLEXIGLAS® can be expected to behave like the corresponding clear (basic) grades.
RC =	resistance to crazing (Röhm test method 'bending test')
CR =	chemical resistance (similar to DIN 53 476)
EP =	exposure period to the chemical in days; one minute in short-term tests
OE =	overall evaluation , i.e. critical summary of the visual inspections for crazing behavior and chemical resistance

+ = resistant
o = limited resistance
- = not resistant

2.2 Listing of results

Alcohol, mono- and polyhydric

Chemical Conc	Mat	RC	CB	EZ	Evaluation of CR	CR, short-term test	OE
1-Butanol							
100%	233	-	-	28	crazing, swelling	no change	-
100%	XT	-	-	7	pronounced swelling, whitening	no change	-
100%	XT-R	-	-	1	softening, whitening, pronounced swelling	no change	-
1-Hexyl alcohol							
98%	233	-	+	28	no change	no change	o
98%	XT	-	o	28	very slight swelling	no change	-
98%	XT-R	-	-	7	swelling, whitening, dulling	no change	-
1-Methoxy-2-propyl alcohol							
99%	233	-	-	1	pronounced swelling, chemical attack	no change	-
99%	XT	-	-	7	pronounced chemical attack	no change	-
99%	XT-R	-	-	1	specimens dissolved	surface haze	-
n-amyl alcohol							
100%	233	-	o	28	crazing, swelling	no change	-
100%	XT	-	-	28	haze, swelling	no change	-
100%	XT-R	-	-	1	softening, whitening, pronounced swelling	no change	-
Isopropyl alcohol							
100%	233	-	-	7	swelling, crazing	no change	-
100%	XT	-	-	7	swelling, whitening, crazing	no change	-
100%	XT-R	-	-	1	swelling, whitening, dulling	no change	-

Cyclohexanol							
99,5%	233	-	+	28	no change	no change	o
99,5%	XT	-	+	28	no change	no change	o
99,5%	XT-R	-	-	7	swelling, whitening, dulling	no change	-
Ethyl alcohol							
100%	233	-	-	7	softening, swelling	no change	-
100%	XT	-	-	1	swelling	no change	-
100%	XT-R	-	-	1	softening, swelling, whitening	no change	-
50%	233	-	-	7	swelling	no change	-
50%	XT	-	-	1	swelling	no change	-
50%	XT-R	+	-	1	swelling, whitening, dulling	no change	-
Ethylene glycol							
100%	233	-	+	28	no change	no change	o
100%	XT	-	+	28	no change	no change	o
100%	XT-R	-	+	28	no change	no change	o
Ethylene glycol (antifreeze)							
50%	233	+	+	28	no change	no change	+
50%	XT	+	+	28	no change	no change	+
50%	XT-R	+	o	28	slight haze	no change	o
Glycerol							
98%	233	+	+	28	no change	no change	+
98%	XT	+	+	28	no change	no change	+
98%	XT-R	+	+	28	no change	no change	+
Methyl alcohol							
100%	233	-	-	1	softening, swelling	no change	-
100%	XT	-	-	1	softening, swelling	no change	-
100%	XT-R	-	-	1	softening swelling, whitening	slight haze	-
Phenol (dissolved in water)							
5%	233	-	-	1	whitening, tackiness, swelling	no change	-
5%	XT	-	-	1	whitening, tackiness, swelling	no change	-
5%	XT-R	-	-	1	whitening, tackiness, swelling	no change	-

Organic solvents, fuels

Chemical Conc	Mat	RC	CB	EZ	Evaluation of CR	CR, short-term test	OE
Butyl acetate							
99%	233	-	-	1	pronounced swelling, chemical attack	no change	-
99%	XT	-	-	7	pronounced chemical attack	no change	-
99%	XT-R	-	-	1	specimens dissolved	swelling, attack, whitening	-

Acetic ether (ethyl acetate)							
99%	233	-	-	1	pronounced swelling, chemical attack	no change	-
99%	XT	-	-	1	pronounced chemical attack	surface slightly dull	-
99%	XT-R	-	-	1	specimens dissolved	swelling, chemical attack, dulling	-
Pentyl acetate (amyl acetate)							
98%	233	-	-	28	swelling, chemical attack	no change	-
98%	XT	-	-	28	pronounced chemical attack	no change	-
98%	XT-R	-	-	1	specimens dissolved	slight chemical attack, dulling	-
Acetone							
99%	233	-	-	28	pronounced swelling, chemical attack	no change	-
99%	XT	-	-	1	specimens dissolved	slight chemical attack, slight dulling	-
99%	XT-R	-	-	1	specimens dissolved	swelling, chemical attack, whitening	-
Cyclohexanone							
99%	233	-	-	7	specimens severely attacked	no change	-
99%	XT	-	-	28	pronounced chemical attack	no change	-
99%	XT-R	-	-	1	specimens dissolved	dull surface	-
Diethyl ketone							
99%	233	-	-	1	pronounced swelling, chemical attack	no change	-
99%	XT	-	-	1	pronounced chemical attack	slight chemical attack, slight dulling	-
99%	XT-R	-	-	1	specimens dissolved	swelling, chemical attack, whitening	-
Ethyl methyl ketone							
99,5%	233	-	-	1	pronounced swelling, chemical attack	no change	-
99,5%	XT	-	-	1	pronounced chemical attack	slight chemical attack, slight dulling	-
99,5%	XT-R	-	-	1	specimens dissolved	swelling, chemical attack, whitening	-
Cyclohexane							
99,5%	233	-	+	28	no change	no change	o
99,5%	XT	-	+	28	no change	no change	o
99,5%	XT-R	-	-	28	swelling, whitening	no change	-
Isooctane							
99,5%	233	-	+	28	no change	no change	o
99,5%	XT	-	+	28	no change	no change	o
99,5%	XT-R	-	o	28	slight haze	no change	-

n-Heptane							
99%	233	-	+	28	no change	no change	o
99%	XT	-	+	28	no change	no change	o
99%	XT-R	-	-	28	swelling, colour change to opaque white	no change	-
n-Hexan							
99%	233	-	+	28	no change	no change	o
99%	XT	-	+	28	no change	no change	o
99%	XT-R	-	-	28	swelling, whitening	no change	-
Formamide							
99%	233	-	+	28	no change	no change	o
99%	XT	-	+	28	no change	no change	o
99%	XT-R	-	+	28	no change	no change	o
n-Methylformamide							
99%	233	-	-	7	swelling, haze	no change	-
99%	XT	-	-	1	swelling, chemical attack, whitening	no change	-
99%	XT-R	-	-	1	swelling, whitening, dulling	no change	-
Perchloroethylene (tetrachloroethylene)							
99%	233	-	-	28	dulling, softening of surface	no change	-
99%	XT	-	-	1	swelling, slight chemical attack	no change	-
99%	XT-R	-	-	1	pronounced swelling + chemical attack	no change	-
Shellsol T							
	233	-	+	28	no change	no change	o
	XT	-	+	28	no change	no change	o
	XT-R	-	o	28	slight haze	no change	-
Turpentine substitute							
	233	-	+	28	no change	no change	o
	XT	-	+	28	no change	no change	o
	XT-R	-	-	7	swelling, whitening	no change	-
Turpentine oil DAB 7							
	233	-	+	28	no change	no change	o
	XT	-	+	28	no change	no change	o
	XT-R	-	-	7	swelling, whitening	no change	-
Carbon tetrachloride							
99%	233	-	-	1	swelling, slight chemical attack	no change	-
99%	XT	-	-	1	pronounced chemical attack	no change	-
99%	XT-R	-	-	1	partial dissolution	no change	-
Diesel fuel DIN 51601							
	233	-	+	28	no change	no change	o
	XT	-	+	28	no change	no change	o
	XT-R	-	o	28	colour change to transparent brown	no change	-

FAM test fuel DIN 51604 A							
	233	-	-	1	pronounced swelling, tackiness	no change	-
	XT	-	-	1	chemical attack, swelling, whitening	slight dulling, slight chemical attack	-
	XT-R	-	-	1	pronounced swelling, chemical attack	haze, chemical attack, swelling	-
FAM test fuel DIN 51604 B							
	233	-	-	1	chemical attack, swelling	slight haze	-
	XT	-	-	1	chemical attack, swelling	haze, chemical attack, swelling	-
	XT-R	-	-	1	chemical attack, swelling, whitening	haze, chemical attack, swelling	-
FAM test fuel DIN 51604 C							
	233	-	-	1	chemical attack, swelling	no change	-
	XT	-	-	1	chemical attack, swelling	haze, whitening, chemical attack	-
	XT-R	-	-	1	chemical attack, swelling, softening	haze, whitening, chemical attack	-
Fuel No. 1 DIN 53521							
	233	-	+	28	no change	no change	o
	XT	-	+	28	no change	no change	o
	XT-R	-	o	28	slight haze	no change	-
Fuel No. 2 DIN 53521							
	233	-	+	28	no change	no change	o
	XT	-	-	28	slight swelling	no change	-
	XT-R	-	-	1	swelling, whitening	no change	-
Petrol, regular (unleaded)							
	233	-	-	28	swelling, yellowing	no change	-
	XT	-	-	7	swelling, dulling, softening	no change	-
	XT-R	-	-	1	swelling, colour change to brown, dulling	whitening of surface, dulling	-
Petrol, regular (leaded)							
	233	-	-	28	colour change to light brown	no change	-
	XT	-	-	28	swelling, colour change to light brown	no change	-
	XT-R	-	-	1	pronounced swelling, softening, colour change to brown	whitening of surface, dulling	-

Petrol, supergrade (unleaded)							
	233	-	-	28	swelling, yellowing	no change	-
	XT	-	-	7	swelling, dulling, softening	no change	-
	XT-R	-	-	1	swelling, colour change to brown, dulling	whitening of surface, dulling	-
Petrol, supergrade (leaded)							
	233	-	-	7	swelling, softening, yellowing	no change	-
	XT	-	-	1	swelling, dulling, softening	no change	-
	XT-R	-	-	1	very pronounced swelling, whitening	whitening of surface, dulling	-
Petroleum							
	233	-	+	28	no change	no change	o
	XT	-	+	28	no change	no change	o
	XT-R	-	o	28	haze, slight yellowing	no change	-

Acids, organic and inorganic

Chemical Conc	Mat	RC	CB	EZ	Evaluation of CR	CR, short-term test	OE
Citric acid							
10%	233	+	+	28	no change	no change	+
10%	XT	+	+	28	no change	no change	+
10%	XT-R	+	o	28	specimens hazy, whitening	no change	o
38%	233	+	+	28	no change	no change	+
38%	XT	+	+	28	no change	no change	+
38%	XT-R	+	o	28	slight haze	no change	o
Formic acid							
5%	233		+	28	no change	no change	
5%	XT		+	28	no change	no change	
5%	XT-R		o	28	slight haze	no change	
Acetic acid							
100%	233	-	-	1	specimens dissolved	no change	-
100%	XT	-	-	1	specimens dissolved	slight chemical attack	-
100%	XT-R	-	-	1	specimens dissolved	pronounced chemical attack, whitening	-
5%	233	+	+	28	no change	no change	+
5%	XT	+	+	28	no change	no change	+
5%	XT-R	+	o	28	specimens hazy, whitening	no change	o
Hydrofluoric acid							
40%	233	-	-	1	swelling, softening, whitening	slight swelling	-
40%	XT	-	-	1	swelling, softening, whitening	very slight dulling, swelling	-
40%	XT-R	-	-	1	swelling, softening, whitening	slight dulling, slight swelling	-

Lactic acid							
20%	233	-	+	28	no change	no change	o
20%	XT	-	+	28	no change	no change	o
20%	XT-R	-	o	28	haze, whitening	no change	-
90%	233	-	-	7	pronounced swelling, whitening, softening	no change	-
90%	XT	-	-	1	pronounced chemical attack, whitening	no change	-
90%	XT-R	-	-	1	pronounced chemical attack, whitening	no change	-
Oxalic acid							
8,7%	233	+	+	28	no change	no change	+
8,7%	XT	+	+	28	no change	no change	+
8,7%	XT-R	+	o	28	haze, whitening	no change	o
Phosphoric acid							
10%	XT	+	+	28	no change	no change	+
10%	233	+	+	28	no change	no change	+
10%	XT-R	+	o	28	haze, whitening	no change	o
50%	XT	-	+	28	no change	no change	o
50%	233	-	+	28	no change	no change	o
50%	XT-R	+	+	28	no change	no change	+
85%	233	-	-	1	pronounced swelling	no change	-
85%	XT	-	-	1	pronounced swelling, chemical attack	no change	-
85%	XT-R	-	-	1	pronounced swelling, chemical attack	no change	-
Nitric acid							
10%	233	+	+	28	no change	no change	+
10%	XT	+	+	28	no change	no change	+
10%	XT-R	+	o	28	yellowing, haze	no change	o
40%	233	-	+	28	no change	no change	o
40%	XT	-	+	28	no change	no change	o
40%	XT-R	-	-	28	colour change to opaque grey	no change	-
65%	233	-	-	1	very pronounced swelling, softening	dulling, whitening, swelling	-
65%	XT	-	-	1	very pronounced swelling, softening	dulling, whitening, swelling	-
65%	XT-R	-	-	1	very pronounced swelling, softening	dulling, whitening, swelling	-
Hydrochloric acid							
10%	233	+	+	28	no change	no change	+
10%	XT	+	+	28	no change	no change	+
10%	XT-R	+	o	28	whitening, haze	no change	o
32%	233	+	+	28	no change	no change	+
32%	XT	+	+	28	no change	no change	+
32%	XT-R	+	o	28	color change to grey, slight haze	no change	o

Sulphuric acid							
3%	233	+	+	28	no change	no change	+
3%	XT	+	+	28	no change	no change	+
3%	XT-R	+	o	28	whitening, haze	no change	o
30%	233	+	+	28	no change	no change	+
30%	XT	+	+	28	no change	no change	+
30%	XT-R	+	o	1	slight haze	no change	o
98%	233	-	-	1	pronounced swelling, whitening	dulling, whitening, swelling	-
98%	XT	-	-	1	pronounced swelling	dulling, whitening, swelling	-
98%	XT-R	-	-	1	pronounced swelling, reddening	dulling, whitening, swelling	-
Sulphamic acid (amidosulphonic acid)							
18%	233	+	+	28	no change	no change	+
18%	XT	+	+	28	no change	no change	+
18%	XT-R	+	o	28	haze, whitening	no change	o
Tartaric acid							
50%	233	+	+	28	no change	no change	+
50%	XT	+	+	28	no change	no change	+
50%	XT-R	+	o	28	haze, whitening	no change	o
Oleic acid							
99%	233	-	+	28	no change	no change	o
99%	XT	-	+	28	no change	no change	o
99%	XT-R	-	o	28	slight haze, dulling	no change	-

Alkalis

Chemical Conc	Mat	RC	CB	EZ	Evaluation of CR	CR, short-term test	OE
Ammonia solution							
10%	233	+	+	28	no change	no change	+
10%	XT	+	+	28	no change	no change	+
10%	XT-R	+	o	28	whitening (haze)	no change	o
25%	233	+	+	28	no change	no change	+
25%	XT	+	+	28	no change	no change	+
25%	XT-R	+	o	28	whitening	no change	o
Caustic soda solution							
1%	233	+	+	28	no change	no change	+
1%	XT	+	+	28	no change	no change	+
1%	XT-R	+	o	28	haze, whitening	no change	o
10%	233	+	+	28	no change	no change	+
10%	XT	+	+	28	no change	no change	+
10%	XT-R	+	+	28	no change	no change	+
30%	233	+	+	28	no change	no change	+
30%	XT	+	+	28	no change	no change	+
30%	XT-R	+	+	28	no change	no change	+

Salts, organic and inorganic (saturated solutions)

Chemical Conc	Mat	RC	CB	EZ	Evaluation of CR	CR, short-term test	OE
Aluminium chloride							
42%	233	+	+	28	no change	no change	+
42%	XT	+	+	28	no change	no change	+
42%	XT-R	+	o	28	slight haze	no change	o
Ferric sulphate							
21%	233	+	+	28	no change	no change	+
21%	XT	+	+	28	no change	no change	+
21%	XT-R	+	o	28	haze, whitening	no change	o
Ferric chloride							
48%	233	+	o	28	color change to light brown	no change	o
48%	XT	+	o	28	color change to light brown	no change	o
48%	XT-R	+	o	28	yellowing, haze, dulling	no change	o
Aluminium potassium sulphate							
5%	233	+	+	28	no change	no change	+
5%	XT	+	+	28	no change	no change	+
5%	XT-R	+	o	28	haze, whitening	no change	o
Potassium carbonate							
50%	233	+	+	28	no change	no change	+
50%	XT	+	+	28	no change	no change	+
50%	XT-R	+	+	28	no change	no change	+
Potassium chloride							
25%	233	+	+	28	no change	no change	+
25%	XT	+	+	28	no change	no change	+
25%	XT-R	+	+	28	no change	no change	+
Potassium nitrate							
24%	233	+	+	28	no change	no change	+
24%	XT	+	+	28	no change	no change	+
24%	XT-R	+	o	28	haze, whitening	no change	o
Potassium permanganate							
6%	233	+	+	28	dulling, surface turning brown	no change	+
6%	XT	+	+	28	dulling, surface turning brown	no change	+
6%	XT-R	+	+	28	dulling, surface turning black	no change	+
Potassium sulphate							
10%	233	+	+	28	no change	no change	+
10%	XT	+	+	28	no change	no change	+
10%	XT-R	+	o	28	slight haze	no change	o
Copper sulphate							
17%	233	+	+	28	no change	no change	+
17%	XT	+	+	28	no change	no change	+
17%	XT-R	+	o	28	haze, whitening	no change	o
Magnesium sulphate							
21%	233	+	+	28	no change	no change	+
21%	XT	+	+	28	no change	no change	+
21%	XT-R	+	+	28	slight haze	no change	o
Sodium acetate							
32%	233	+	+	28	no change	no change	+
32%	XT	+	+	28	no change	no change	+
32%	XT-R	+	+	28	no change	no change	+

Sodium carbonate (soda ash)							
2%	233	+	+	28	no change	no change	+
2%	XT	+	+	28	no change	no change	+
2%	XT-R	+	o	28	specimens hazy, whitening	no change	o
20%	233	+	+	28	no change	no change	+
20%	XT	+	+	28	no change	no change	+
20%	XT-R	+	o	28	specimens hazy	no change	o
Sodium chloride (common salt)							
10%	233	+	+	28	no change	no change	+
10%	XT	+	+	28	no change	no change	+
10%	XT-R	+	o	28	haze, whitening	no change	o
Sodium phosphate							
20%	233	+	+	28	no change	no change	+
20%	XT	+	+	28	no change	no change	+
20%	XT-R	+	o	28	slight haze	no change	o
Sodium dihydrogen phosphate							
50%	233	+	+	28	no change	no change	+
50%	XT	+	+	28	no change	no change	+
50%	XT-R	+	o	28	very slight haze	no change	o
Disodium hydrogen phosphate							
8,5%	233	+	+	28	no change	no change	+
8,5%	XT	+	+	28	no change	no change	+
8,5%	XT-R	+	o	28	haze, whitening	no change	o
Sodium hydrogen sulphate							
40%	233	+	+	28	no change	no change	+
40%	XT	+	+	28	no change	no change	+
40%	XT-R	+	o	28	haze, whitening	no change	o
Sodium nitrate							
45%	233	+	+	28	no change	no change	+
45%	XT	+	+	28	no change	no change	+
45%	XT-R	+	o	28	slight haze	no change	o
Sodium sulphate (Glauber's salt)							
25%	233	+	+	28	no change	no change	+
25%	XT	+	+	28	no change	no change	+
25%	XT-R	+	o	28	haze, whitening	no change	o
Sodium chlorate							
49%	233	+	+	28	no change	no change	+
49%	XT	+	+	28	no change	no change	+
49%	XT-R	+	o	28	haze, whitening	no change	o
Sodium thiosulphate							
41%	233	+	+	28	no change	no change	+
41%	XT	+	+	28	no change	no change	+
41%	XT-R	+	+	28	no change	no change	+
Zinc chloride							
50%	233	o	+	28	no change	no change	o
50%	XT	o	+	28	no change	no change	o
50%	XT-R	+	o	28	haze, whitening	no change	o

Zinc sulphate							
35%	233	+	+	28	no change	no change	+
35%	XT	+	+	28	no change	no change	+
35%	XT-R	+	o	28	haze, whitening	no change	o
Urea							
51%	233	+	+	28	no change	no change	+
51%	XT	+	+	28	no change	no change	+
51%	XT-R	+	+	28	no change	no change	+
Hydroquinone							
6,7%	233	-	o	28	color change to transparent brown	no change	-
6,7%	XT	-	-	28	color change to opaque reddish brown	no change	-
6,7%	XT-R	+	-	28	color change to transparent brown	no change	o

Inorganic compounds

Chemical Conc	Mat	RC	CB	EZ	Evaluation of CR	CR, short-term test	OE
Hydrazine							
15%	233	+	+	28	no change	no change	+
15%	XT	+	+	28	no change	no change	+
15%	XT-R	+	+	28	no change	no change	+
Hydrogen peroxide (hydrogen dioxide, Perhydrol)							
3%	233	+	+	28	no change	no change	+
3%	XT	+	+	28	no change	no change	+
3%	XT-R	+	o	28	haze, whitening	no change	o
30%	233	+	+	28	no change	no change	+
30%	XT	+	+	28	no change	no change	+
30%	XT-R	+	o	28	haze, whitening	no change	o
Sodium hypochlorite							
12%	233	+	+	28	no change	no change	+
12%	XT	+	+	28	no change	no change	+
12%	XT-R	+	o	28	haze, whitening	no change	o
Water, demineralised							
	233	+	+	28	no change	no change	+
	XT	+	+	28	no change	no change	+
	XT-R	+	+	28	no change	no change	+

Organic compounds

Chemical Conc	Mat	RC	CB	EZ	Evaluation of CR	CR, short-term test	OE
Dibutyl phthalate							
99%	233	-	-	28	chemical attack	no change	-
99%	XT	-	-	28	chemical attack	no change	-
99%	XT-R	-	-	1	swelling, chemical attack, whitening	no change	-

Diisobutyl phthalate							
97%	233		+	28	no change	no change	
97%	XT		-	28	chemical attack	no change	-
97%	XT-R		-	28	pronounced chemical attack, haze, crazing	no change	-
Paraffin, liquid							
100%	233	+	+	28	no change	no change	+
100%	XT	+	+	28	no change	no change	+
100%	XT-R	+	+	28	no change	no change	+
Di(2-ethylhexyl) sebacate (dioctyl sebacate)							
	233	-	+	28	no change	no change	o
	XT	-	+	28	no change	no change	o
	XT-R	-	+	28	no change	no change	o
Triorthocresyl-phosphate							
	233	-	+	28	no change	no change	o
	XT	-	-	28	no change	no change	-
	XT-R	-	-	7	chemical attack, dulling	no change	-
Rizinusöl							
	233	-	+	28	no change	no change	+
	XT	-	+	28	no change	no change	+
	XT-R	-	+	28	no change	no change	o
Sojabohnenöl							
	233	-	+	28	no change	no change	o
	XT	-	+	28	no change	no change	o
	XT-R	-	+	28	no change	no change	o
Triethanolamin							
98%	233	+	+	28	no change	no change	+
98%	XT	-	+	28	no change	no change	o
98%	XT-R	+	+	28	no change	no change	+

© = registered trademark

PLEXIGLAS, PLEXIGLAS RESIST and PLEXIGLAS SOUNDSTOP are registered trademarks of Evonik Röhm GmbH, Darmstadt, Germany.

Certified to DIN EN ISO 9001 (quality) and DIN EN ISO 14001 (environment)

This information and all further technical advice is based on our present knowledge and experience. However, it implies no liability or other legal responsibility on our part, also with regard to existing third party intellectual property rights, especially patent rights. In particular, no warranty, whether express or implied, or guarantee of product properties in the legal sense is intended or implied. We reserve the right to make any changes according to technological progress or further developments. The customer is not released from the obligation to conduct careful inspection and testing of incoming goods. Performance of the product described herein should be verified by testing, which should be carried out only by qualified experts in the sole responsibility of a customer. Reference to trade names used by other companies is neither a recommendation, nor does it imply that similar products could not be used.

Ref. No. 211-4 May 2000

Business Unit Performance Polymers

Evonik Röhm GmbH Kirschenallee, 64293 Darmstadt, Germany.
info@plexiglas.net www.plexiglas.net www.evonik.com