

# FLUOstar OPTIMA POLARstar OPTIMA LUMIstar OPTIMA

## Operating Manual

Revision I

This manual was designed to guide FLUOstar OPTIMA, POLARstar OPTIMA and LUMIstar OPTIMA users through the basic hardware features of the instrument.

**Headquarters****Germany**

BMG LABTECH GmbH  
Hanns-Martin-Schleyer Str. 10  
77656 Offenburg  
Phone: +49 781 96968-0  
Fax: +49 781 96968-67  
germany@bmglabtech.com

**Subsidiaries****Australia**

BMG LABTECH Pty. Ltd.  
P.O. Box 469  
Mount Eliza, Victoria 3930  
Phone: +61 3 5973 4744  
Fax: +61 3 5973 4711  
australia@bmglabtech.com

**France**

BMG LABTECH SARL  
7, Rue Roland Martin  
94500 Champigny s/ Marne  
Phone: +33 1 48 86 20 20  
Fax: +33 1 48 86 47 07  
france@bmglabtech.com  
France

**Japan**

BMG LABTECH Japan Ltd.  
2F TS-1 Building, 1-6-2, Shimo-cho  
Omiya-ku, 330-0844  
Saitama City, Japan  
Phone: +81 48 647 7217  
Fax: +81 48 647 7218  
japan@bmglabtech.com

**United Kingdom**

BMG LABTECH Ltd.  
P.O. Box 73  
Aylesbury, HP 20 2 QJ  
United Kingdom  
Phone: +44 1296 33 66 50  
Fax: +44 1296 33 66 51  
uksales@bmglabtech.com

**USA**

BMG LABTECH Inc.  
2415 Presidential Dr.,  
Bldg. 204, Suite 118  
Durham, NC 27703  
Phone: +1 919 806 1735  
Fax: +1 919 806 8526  
usa@bmglabtech.com

# FLUOstar OPTIMA, POLARstar OPTIMA & LUMIstar OPTIMA

The FLUOstar OPTIMA is a multifunctional microplate reader that can perform a wide variety of applications for fluorescence intensity, time-resolved fluorescence, absorbance and luminescence.

The POLARstar OPTIMA can measure in the above-mentioned modes and additionally in fluorescence polarization mode and simultaneous dual emission.

The LUMIstar OPTIMA is a luminescence microplate reader that can be upgraded to include all above mentioned modes.

The versatile optical system allows switching from top to bottom optics.

All instruments achieve high-performance measurement data in a wide wavelength range. The instruments have a built-in incubator and can be configured with up to two reagent injectors.

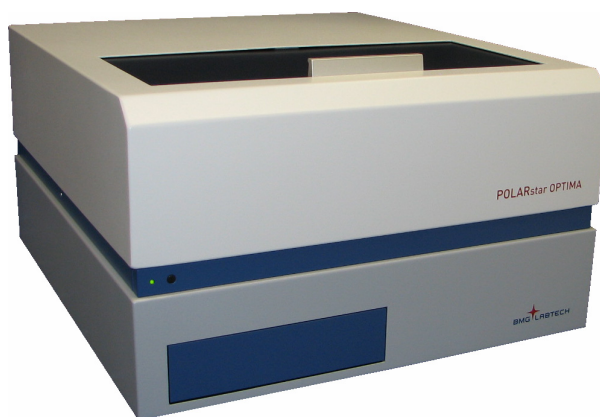

*Figure 1: POLARstar OPTIMA*

**TABLE OF CONTENTS**

<b>1</b>	<b>TECHNICAL SPECIFICATIONS</b>	<b>5</b>
<b>2</b>	<b>INSTALLATION</b>	<b>7</b>
2.1	TRANSPORT PIN	7
2.2	POWER AND COMMUNICATION CONNECTIONS	8
<b>3</b>	<b>INSTRUMENT OVERVIEW</b>	<b>9</b>
<b>4</b>	<b>DESCRIPTION OF COMPONENTS</b>	<b>11</b>
4.1	OPTICS	11
4.2	INSTALLATION AND CHANGING OF OPTICS	11
4.2.1	COMBINATION OPTICS (FLUORESCENCE INTENSITY AND ABSORBANCE)	12
4.2.2	FLUORESCENCE INTENSITY OPTICS	13
4.2.3	ABSORBANCE OPTICS	13
4.2.4	LUMINESCENCE OPTICS	14
4.2.5	FLUORESCENCE POLARIZATION OPTICS	14
4.2.6	DUAL EMISSION OPTICS	15
4.2.7	HIGH DENSITY OPTICS	15
4.2.8	BOTTOM OPTICS	16
4.3	384-WELL INJECTION HEAD	16
4.4	FILTERS	17
4.4.1	FILTER CHANGE AND INSTALLATION	17
4.4.2	FLUORESCENCE FILTERS	19
4.4.3	FLUORESCENCE POLARIZATION FILTERS	19
4.4.4	DUAL EMISSION FILTERS	19
4.4.5	ABSORBANCE FILTERS	19
4.4.6	LUMINESCENCE FILTERS	19
4.5	SPACERS	20
4.6	REAGENT INJECTORS	21
4.6.1	USE AND MAINTENANCE OF THE REAGENT INJECTORS	21
<b>5</b>	<b>INSTRUMENT DISINFECTION</b>	<b>22</b>

# 1 Technical Specifications

<b>Measurement principles:</b>	<p>FLUOstar OPTIMA:</p> <ul style="list-style-type: none"> <li>- Fluorescence intensity</li> <li>- Time-resolved fluorescence</li> <li>- Luminescence (opt.)</li> <li>- Absorbance (opt.)</li> <li>- Upgradeable to POLARstar OPTIMA</li> </ul> <p>POLARstar OPTIMA:</p> <ul style="list-style-type: none"> <li>- Fluorescence polarization</li> <li>- Simultaneous dual emission fluorescence</li> <li>- Fluorescence intensity</li> <li>- Time-resolved fluorescence</li> <li>- Luminescence (opt.)</li> <li>- Simultaneous dual emission luminescence (opt.)</li> <li>- Absorbance (opt.)</li> </ul> <p>LUMIstar OPTIMA:</p> <ul style="list-style-type: none"> <li>- Luminescence</li> <li>- Simultaneous dual emission luminescence (opt.)</li> <li>- Upgradeable to FLUOstar / POLARstar OPTIMA</li> </ul>
<b>Light source:</b>	FLUOstar OPTIMA & POLARstar OPTIMA: - High-energy xenon flash-lamp
<b>Detector:</b>	Side window, current type photomultiplier tube
<b>Filters:</b>	<p>FLUOstar OPTIMA &amp; POLARstar OPTIMA: - 2 filter wheels: with 8 excitation and 8 emission filter positions</p> <p>LUMIstar OPTIMA: - Emission filter wheel with 8 filter positions</p>
<b>Gain control:</b>	<p>Software selectable gain</p> <p>Automatic gain adjustment</p>
<b>Plate Carrier:</b>	<p>Auto lock microplate carrier.</p> <p>All microplate formats up to 1536-well in all detection modes.</p> <p>Microplates should fulfil the SBS specification and non-SBS formats should fit: (lxwxh) (mm) max: 128x86x20; min: length 124.</p>
<b>Reagent injectors:</b>	<p>Up to two built-in reagent injectors</p> <p>Individual injection volumes for each well</p> <p>Injection volumes definable down to 3µl</p> <p>Up to 4 independent injection actions per well</p> <p>Variable injection speed (100 µl/s to 420 µl/s)</p>
<b>Shaking:</b>	<p>Linear, orbital and figure eight shaking</p> <p>Programmable shake time and diameter</p>
<b>Incubation:</b>	<p>Incubation range from ambient +8°C to 45°C, in 0.1°C steps</p> <p>Extended incubation up to 60°C (optional)</p> <p>Temperature monitoring (without incubation)</p> <p>Temperature stability 0.2°C</p>
<b>Shortest reading time:</b>	<p>Fluorescence intensity: - 15 s for 96-wells</p> <p style="padding-left: 20px;">- 30 s for 384-wells</p> <p style="padding-left: 20px;">- 57 s for 1536-wells</p> <p>Luminescence: - 20 s for 96-wells</p> <p style="padding-left: 20px;">- 55 s for 384-wells</p>
<b>Fluorescence intensity:</b>	<p>Limit of detection 0.9 fmol / well fluorescein</p> <p>Spectral range (ex. and em.): 240 ... 740 nm</p> <p>Dynamic range 8 decades</p>

<b>Time-resolved fluorescence:</b>	Limit of detection 70 amol / well europium Spectral range (ex. and em.): 240 ... 740 nm Dynamic range: 6 decades
<b>Luminescence:</b>	Limit of detection <50 amol / well ATP Spectral range 240 ... 740 nm Dynamic range: 9 decades
<b>Fluorescence polarization:</b>	Limit of detection: <5 mP SD at 1 nM fluorescein Spectral range: (ex. and em.): 380 ... 740 nm Dynamic range: 4 decades
<b>Absorbance:</b>	Spectral range 240 ... 740 nm Dynamic range 0.000-3.000 OD Reproducibility 0.010 OD for 0-2 OD range, 0.030 OD for 2-3 OD range
<b>Computer interface:</b>	RS232, 38400 baud, binary communication protocol
<b>Power requirements:</b>	100/115/230 V, 50/60 Hz Consumption: max. 205 VA Fuses: - T2.5A/250V for main power 230 V - T3.15A/250V for main power 115 V - T3.15A/250V for main power 100 V (use original spare fuses provided by BMG LABTECH only)
<b>Dimensions:</b>	Height: 27 cm, width: 44 cm and length 48 cm
<b>Weight:</b>	28 kg
<b>Ambient conditions:</b>	Operating temperature: 15°C to 35°C Storage temperature: -10°C to 50°C Humidity of atmosphere: 20% to 80% Non-condensing
<b>Instrument conformity:</b>	Over voltage category II; contamination class II; protection class I
<b>Robotic capabilities:</b>	Stacker for 50 microplates (optional)

## 2 Installation

When unpacking the instrument, please check to ensure that all parts are included.

The shipping box should contain:

- FLUOstar OPTIMA or POLARstar OPTIMA or LUMIstar OPTIMA
- Control and evaluation software (CD ROM in a cover inside this manual)
- Manual
- Power cord
- RS232 cable
- Service box containing:
  - Allen key (1.5mm)
  - 2 extra fuses: T2.5A/250V for main power 230 V  
T3.15A/250V for main power 115 V  
T3.15A/250V for main power 100 V
  - injector needle cleaner (if with reagent injectors)

Call BMG LABTECH immediately if any of these items are missing.

The area designated for the instrument should be free of dust, liquids and acidic vapours. The table's surface should be flat and even. Avoid areas subject to vibrations and direct sunlight.



**Upon unpacking and positioning the reader make sure to unlock the transport pin (section 2.1 Transport Pin) before any power connection (section 2.2 Power and Communication Connections).**

### 2.1 Transport Pin

When the instrument is shipped or moved to a different location, the transport pin should be in the locked position.

The transport pin is located in the back left corner of the reagent box (figure 2). Once the instrument is in its permanent location, the transport pin should be unlocked to free the plate carrier. To do this lift up the transport pin and turn it counter-clockwise and leave the pin in the groove.

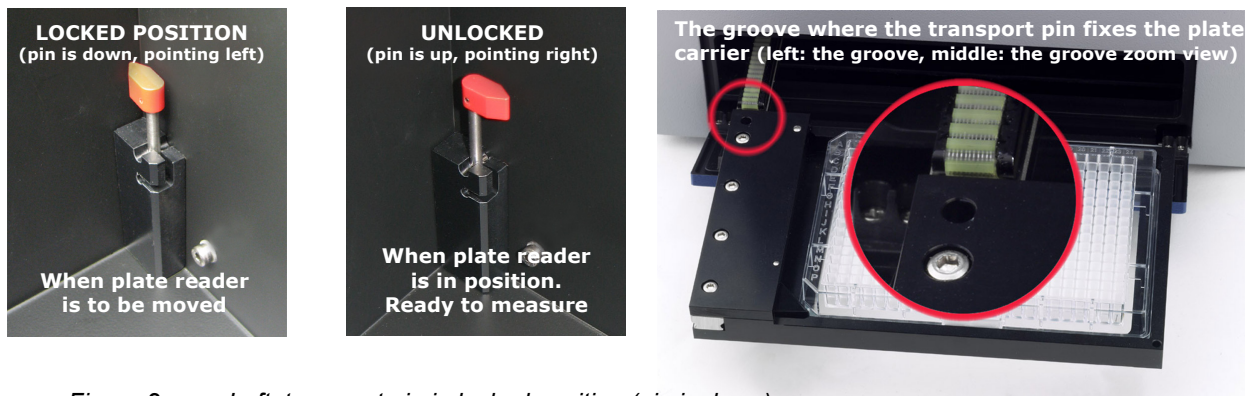

*Figure 2: Left: transport pin in locked position (pin is down). Middle: transport pin in unlocked position (pin is up). Right: the groove where the transport pin can lock the plate carrier*

If the instrument needs to be moved to a new location, the plate carrier should be in the locked position otherwise the transport system could be damaged.

Press and hold the plate in / plate out button for 3 seconds, hereafter the plate carrier will automatically move to its lock position. Once the reader is switched off, the transport pin can be turned (counter clockwise) and moved down.

Also upon shutting down the control software the plate carrier will be moved to its transport lock position.



Figure 3: Plate In / Plate Out button.

#### Check that the transport system is locked:

Open the plate carrier door with a fingernail and check if the plate carrier is fixed by gently trying to move the plate carrier, left to right and front to back. If it is not locked, lift the transport pin and try to position the plate carrier manually until the transport pin falls in position and locks the plate carrier. You may have to move the plate carrier slightly until the pin locks the plate carrier.

## 2.2 Power and Communication Connections



**Before connecting the instrument's power cable and turning the power switch on, make sure the transport pin is unlocked (section 2.1)**

#### • Power Connection

First check that the power switch on the back of the instrument is in the "Off" position. Inspect the voltage information on the label next to the power switch to ensure that it corresponds to the local main power specifications. Also make sure the power cable is grounded. Hereafter the power cable can be connected to the instrument.

#### • Connection Check

Locate the RS232 cable (9-pin type) in the shipping box. Connect it to the FLUOstar OPTIMA (or POLARstar OPTIMA or LUMIstar OPTIMA) and to the RS232 port on the PC.



**Only connect a computer that corresponds to EN 60950 and UL 1950 for data processing instruments**

In order to make a 'Connection check', the software needs to be installed. Please refer to the software manual part of this binder to install the software.

You can perform a connection check within the setup menu of the OPTIMA software (go to 'Setup | Connection' and click 'Connection check').

If the instrument and PC are communicating, a 'Connection OK' message will appear. If there is no connection: first check that the reader is turned on, then try another COM port. If the 'Connection Ok' still does not appear, make sure that it is correctly configured, e.g. not a virtual port.

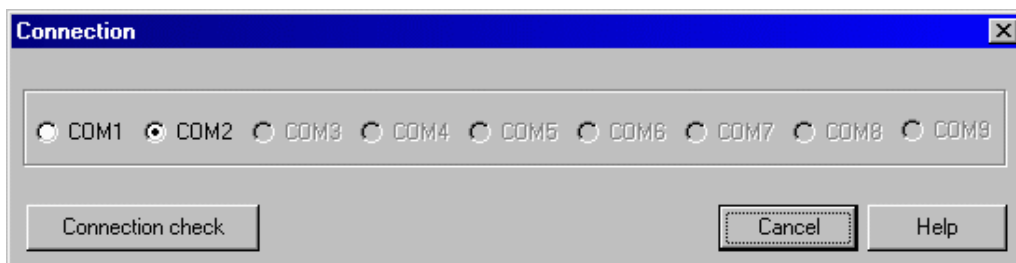

Figure 4: Connection check window ('Setup / Connection')



### 3 Instrument Overview

#### Front View

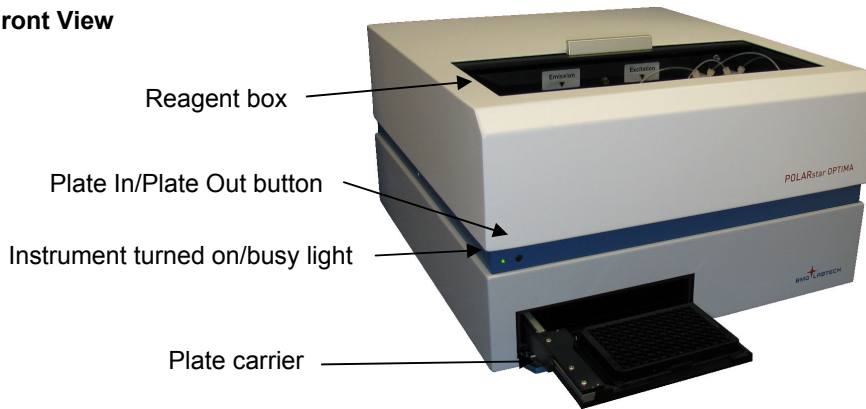

Figure 6: POLARstar OPTIMA

A constant green light means the instrument is turned on. A flashing green light means the instrument is busy (e.g. performing a measurement, plate in/out, priming, etc.). A faster flashing (5 flashes per second) means an error has occurred.

#### Back View

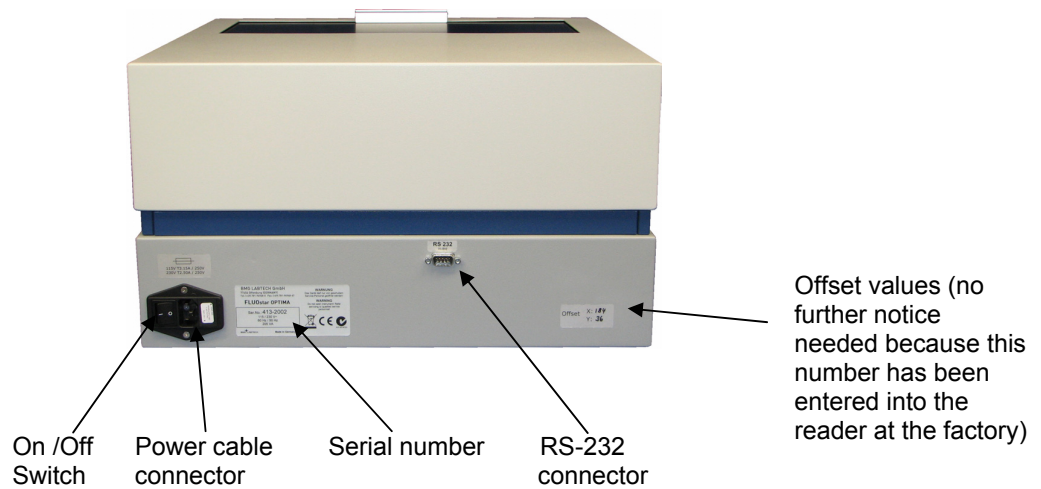
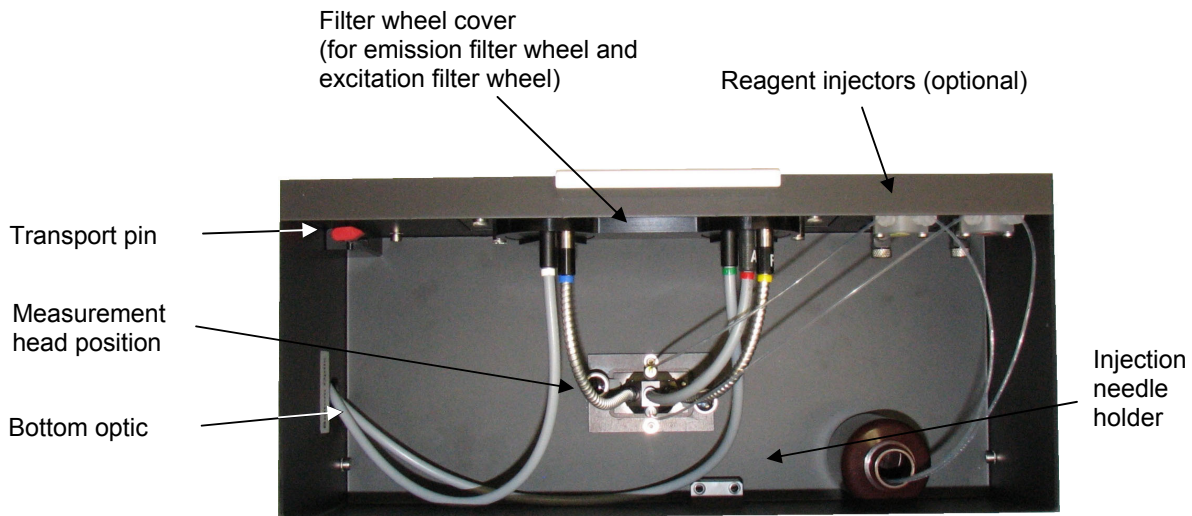

Figure 7: Back of FLUOstar OPTIMA, POLARstar OPTIMA and LUMIstar OPTIMA

**Top View, Reagent Box**

**FLUOstar OPTIMA & POLARstar OPTIMA**



*Figure 8: FLUOstar OPTIMA & POLARstar OPTIMA top view of reagent box with combi-optic and 2 reagent injectors*

**Top View, Reagent Box**

**LUMIstar OPTIMA**

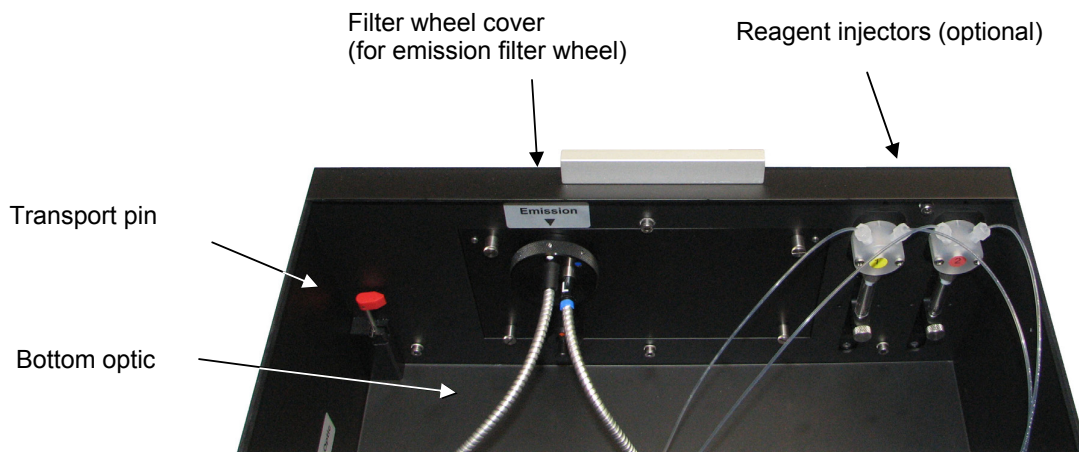

*Figure 9: LUMIstar OPTIMA top view of reagent box with 2 reagent injectors*

## 4 Description of Components

### 4.1 Optics

All standard equipped readers have UV/Vis optics for top reading. For optimal performance, there are different top reading optics available for fluorescence intensity, fluorescence polarization, luminescence, absorbance and time-resolved fluorescence.

### 4.2 Installation and Changing of Optics

The readers are equipped with quick-fix mountings for easy exchange of optics and easy to position spacers (for more about spacers see 4.5). No tools are required for changing the optics. Remove the optic from the positioning wheel by hand and turn the holders on the measurement head frame to release the black mounting piece of the optic.

Quick-fix: in released position

Quick-fix: in fixed position

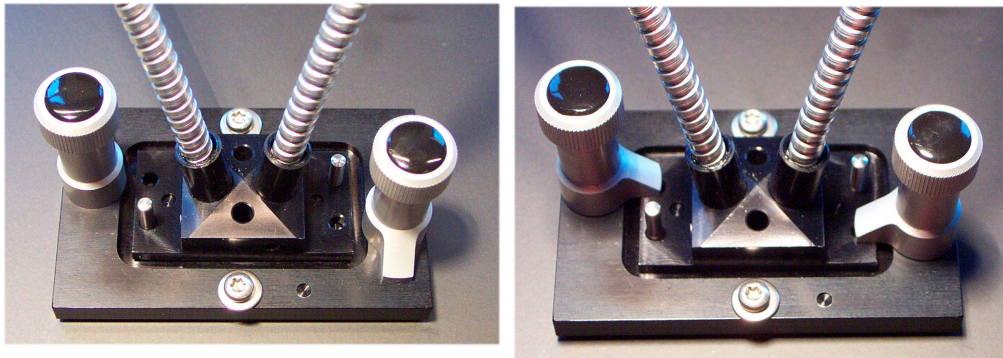

Figure 10: Quick-fix - pull up and turn to change optic



Always hold the optics by the black mounting piece.

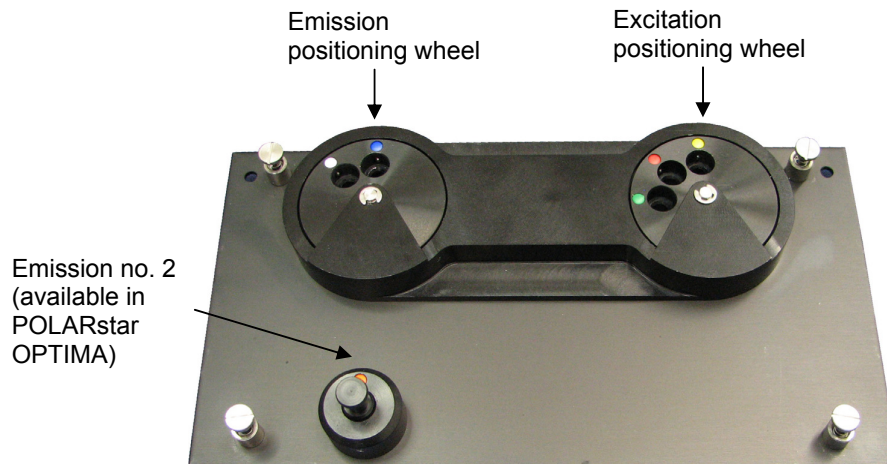

Figure 11: Filter wheel cover with positioning wheels

#### 4.2.1 Combination Optics (Fluorescence Intensity and Absorbance)

The combination optic is made up of two liquid-filled light guides for fluorescence intensity and a quartz fiber for absorbance measurement (figure 12).

To position the measurement head with the quick-fix holders, see chapter 4.2 *Installation and Changing of Optics*.

For fluorescence measurements: excitation enters through the yellow marked light guide and emission is measured through the blue marked light guide.

For absorbance measurements: The grey, red marked, absorbance light guide excites from above and the absorbance is measured through the bottom optic.



Figure 12: Combination optic

Regarding reagent injection: be careful when you position the needles in the measurement head (see figure 13) to avoid damage to the reagent needles as well as to the optic. The optional reagent injectors need to be available.

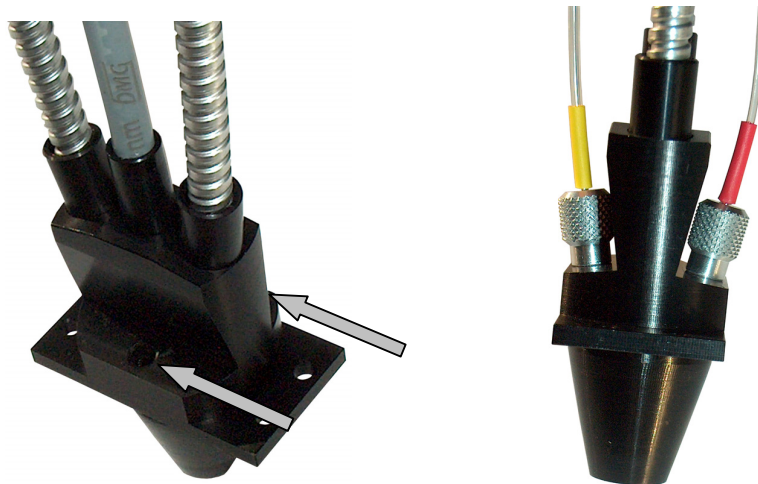

Figure 13: Holes to position reagent needles

### 4.2.2 Fluorescence Intensity Optics

The fluorescence intensity and time-resolved fluorescence light guides are liquid-filled and should be connected to the excitation and emission positioning wheels.

To position the measurement head with the holders, see chapter 4.2 *Installation and Changing of Optics*.

Regarding reagent injection: be careful when you position the needles in the measurement head (see figure 15), to avoid damage to the reagent needles as well as to the optic. The optional reagent injectors need to be available.



Figure 14: Fluorescence intensity optic

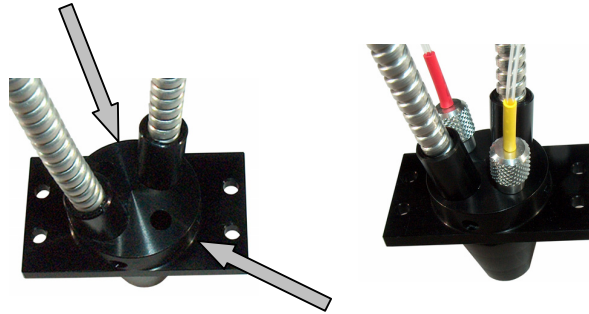

Figure 15: Holes to position reagent needles

### 4.2.3 Absorbance Optics

There is an optimized optic for absorbance mode available (see figure 16). This optimized absorbance optic connects to the red-marked excitation-positioning wheel.

You can also use the combination optic (see chapter 4.2.5).



Figure 16: Optimized absorbance optic



**4.2.4 Luminescence Optics**

The luminescence optic has one light guide, which is silver in colour. The light guide connects to the emission side. To position the measurement head with the holders, see section 4.2 *Installation and Changing of Optics*.

There are two dedicated luminescence versions: one covering up to 96-well formats, with a light guide that is 3 mm in diameter and one that covers plate formats up to 384-well and this is 2 mm in diameter.



Figure 17: Luminescence optics

Regarding reagent injection: be careful when you position the needles in the measurement head (see figure 18), to avoid damage to the reagent needles as well as to the optic. The optional reagent injectors need to be available

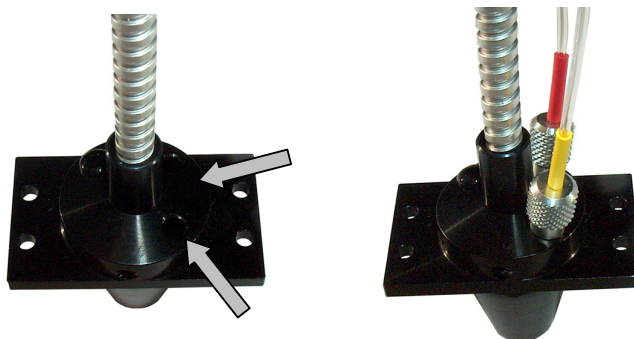

Figure 18: Holes to position reagent needles

For reading the luminescence, the luminescence option needs to be present.

**4.2.5 Fluorescence Polarization Optics**

The light guides for the fluorescence polarization form a triangle at the base of the optic. When positioning the measurement head, make sure the measurement head is oriented so that it points towards the front of the instrument (figure 19).

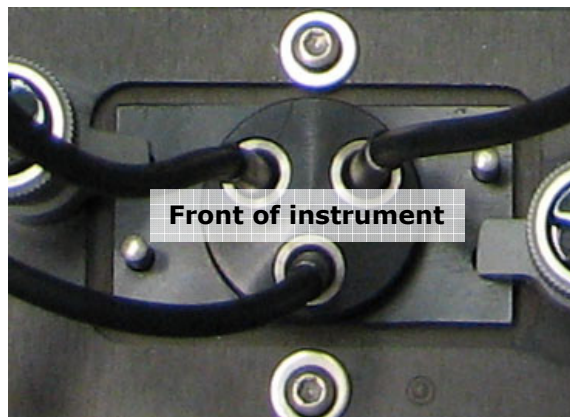

Figure 19: Top view: the fluorescence polarization optic "points" towards the front of instrument.

Position the light guides as follows: right light guide into excitation position, left light guide into the upper emission position (PMT 1) and the center light guide connects to the lower emission position (PMT 2).

Only the POLARstar OPTIMA can measure fluorescence polarization. It is possible to upgrade the FLUOstar OPTIMA to a POLARstar OPTIMA.

Regarding filters for fluorescence polarization, see chapter 4.4.3.



Figure 20: fluorescence polarization measurement head

#### 4.2.6 Dual Emission Optics

The dual emission optics are designed for assays in which you excite at one wavelength and measure two emission wavelengths simultaneously. This is only possible in the POLARstar OPTIMA because this action takes two PMT's. The dual emission optics look like the polarization optics, but are not capable of polarization. The optic has to be installed in the same way as the polarization optic (figure 20).

#### 4.2.7 High Density Optics

The high-density optic has one excitation light guide surrounded by 6 emission light guides. This optic is designed to minimize cross talk in plate formats such as 384- and 1536-well plates.

Insert the black mounting piece into the measurement head socket as described in section 4.2 *Installation and Changing of Optics*.

The single black light guide connects to the yellow-marked position of the excitation wheel. The six-bundled light guides have to be inserted into the blue-marked position of the emission wheel.

Compared to 96-well plates, the 1536-well plates have a low profile. To be able to read this format the "1536 fluorescence option" is needed.

Injection is not possible in 1536 well plate formats.



Figure 21: High density optics

### 4.2.8 Bottom Optics

The bottom optics are used to measure fluorescence, luminescence and absorbance. The bottom optics enter the reagent box on the left side and are connected to the left position of the excitation and emission wheels.

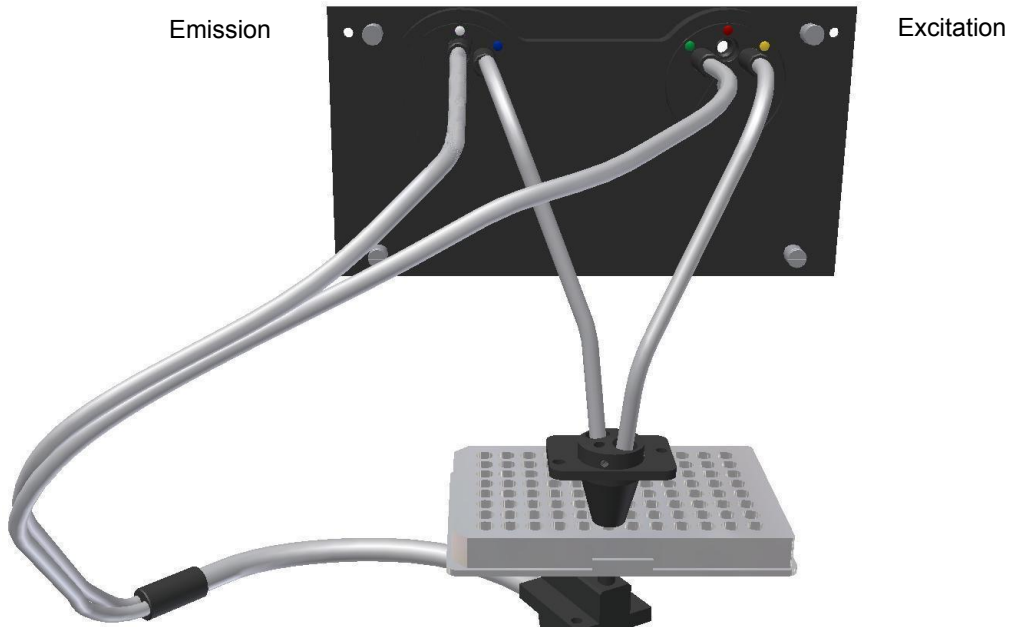

Figure 22: Principle drawing of bottom reading of a 96 well plate

### 4.3 384-Well Injection Head

A special injection head is required in order to inject into 384-well plates. The injection head is installed similarly to an optic (see section 4.2 Installation and Changing of Optics).

This head allows injection from one pump into 384 well formats. The readings must be taken from the bottom. Therefore, both excitation and emission positioning wheels must be switched to the bottom optics. Place the injection needle from the desired pump into the injection head.

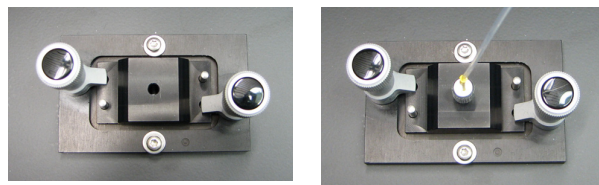

Figure 23: 384-well injection head, bottom reading

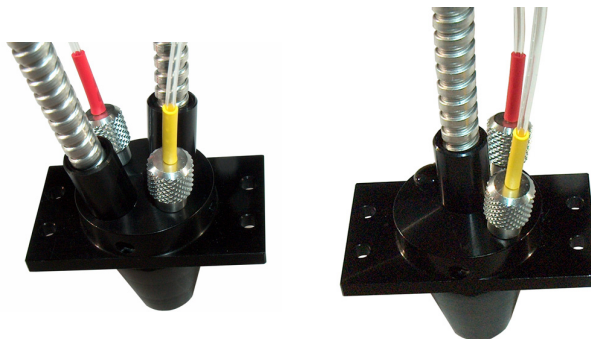

Figure 24: Injection in 384 well formats, top reading



There are 384-well injection optimized optics with the light guides turned in an angle that makes space for the injection to take place.

*Note:* Please be careful when positioning the needle.

### 4.4 Filters

In the FLUOstar Optima, 4 excitation and 4 emission filters are factory installed, in the POLARstar OPTIMA, 4 excitation and 5 emission filters are factory installed. (Filter selection varies with instrument configuration. If your unit is equipped with luminescence, then a lens will be installed. The absorbance option will also add filters.)

The position of the factory-installed filters can be found in the shipment information that follows the instrument.

After installation of the software, the filter must be typed in the filter table (figure 25). In the Control software, the filter table can be reached by choosing 'Setup | Filter' (see the software manual for additional information).

Position	Excitation	Emission
1	355	460
2	544	590
3	485	520
4	584	612
5	A-405	
6	A-450	lens
7	A-492	
8	A-620	empty

Figure 25: Filter table with example of entered values

In the control software you have to type in the filters that are installed ('Setup | Filters'). It is necessary to label the empty position in the emission wheel with a name e.g. "empty".

#### 4.4.1 Filter Change and Installation

All BMG filters have an arrow printed on the side to indicate the direction in which they should be installed. The arrow should point in the same direction as the light. If the filter is being installed in the excitation wheel, the arrow should point outwards toward the front of the unit. If the filter is to be placed in the emission wheel, the arrow should face inward toward the back of the unit.

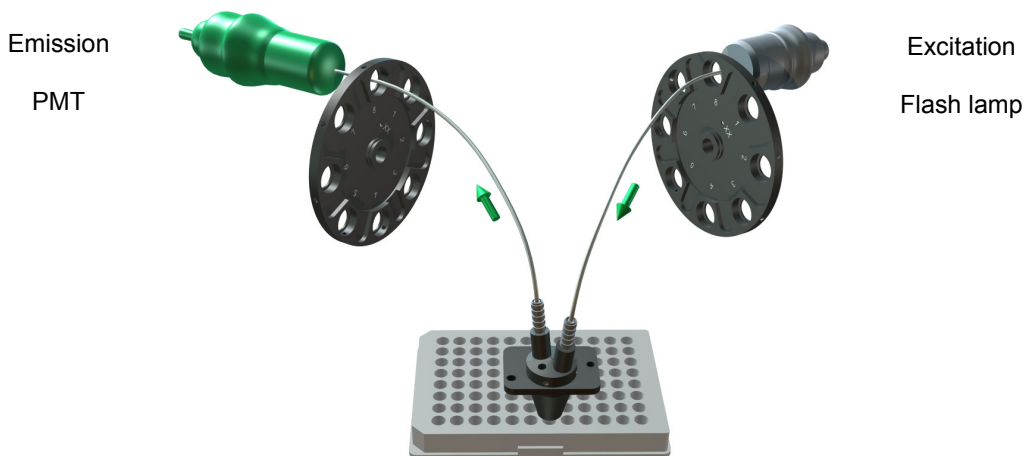

Figure 26: Direction of the light

The excitation filters and the emission filters are located in their respective filter wheels behind the filter wheel cover (figure 27 to figure 29). To access the filters, first remove the light guides. The filter wheel cover can then be removed by loosening the 4 thumbscrews (figure 28).

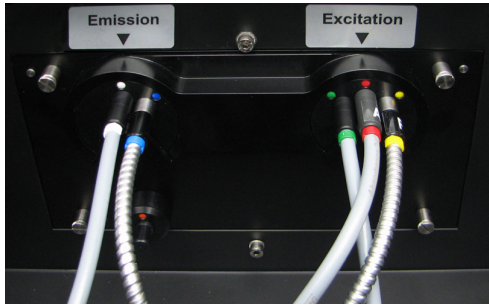

Figure 27: Filter change/Filter installation: First remove the optic (valid for all readers)

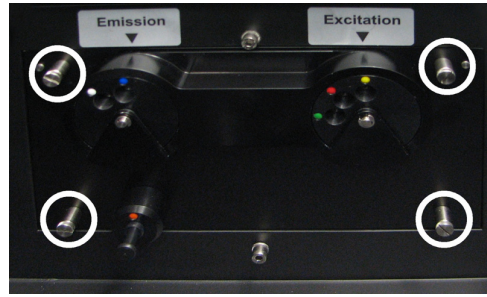

Figure 28: Filter change/Filter installation: Loosen the 4 screws

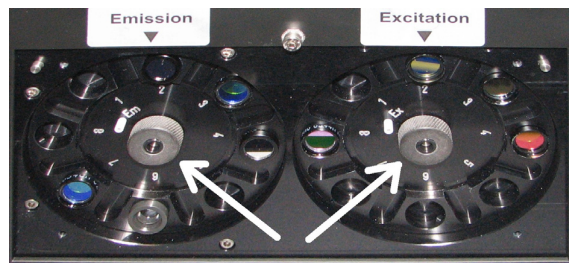

Figure 29: Filter change/Filter installation: Loosen the filter wheel by loosening the nut in the middle (see text for detail description).

The filter wheel itself (figure 30) can be removed by loosening the large retaining nut in the center (figure 29). Put a finger on the filter wheel (careful not to touch any filters) and turn the nut counter clockwise. The filter wheel can be pulled straight out of the housing.

The filter positions are numbered 1 to 8. When installing new filters note the positions and enter the information in the filter table.

Once the filter is in place, it should be fixed with the Allen key and a small filter screw. Place the small screw in the hole on the side of the wheel and turn it only until it is snug (not too tight).



**Do not place a screw in a position that is not equipped with a filter; the screw may slowly loosen and fall out and cause damage to the filter wheel mechanism.**



Carefully tighten (untighten) the small screw that holds the filter

Figure 30: Filter wheel

Next to the axle in the center of the housing is a small positioning pin. This pin must fit into one of the holes on the back of the filter wheel. Replace the filter wheel on the axle and push it in position (the axle should stick out 3mm). Turning the filter wheel quickly might help in position it correctly. Place the filter wheel nut on the axle and hand tighten it until it is snug. Spin the wheel again. The filter wheel should move freely and move without vibration. If the wheel seems to drag or wobble, tighten the nut more or remove and reposition the wheel.

Replace the cover and reconnect the light guides.



If the instrument makes a grinding sound it is very likely that the large filter wheel nut in the middle should be tightened better or that a filter screw is loose.

#### 4.4.2 Fluorescence Filters

The fluorescence filters have a bandwidth that varies dependant upon type of fluorescence filter. Filters optimized for specific fluorophores can vary in the bandwidth from around 10 nm to around 30 to 40 nm (measured at ½ height). BMG-10 filters are symmetrical filters that in ½ height have a bandwidth of 10 nm and hence can be used in both in the excitation and the emission position.

#### 4.4.3 Fluorescence Polarization Filters

The excitation filters can go in any available position in the excitation wheel. The emission wheel has two filters of the same wavelength for each channel. They should be positioned 180° from each other (for example position 3 and position 7 for the 520 filter). The filter configuration can be entered in 'Setup | Filters'.

#### 4.4.4 Dual Emission Filters

As for fluorescence polarization, the excitation filter can be placed in any position. The emission filters to be used in dual emission measurement should be positioned 180° from each other (emission position 1 pairs with position 5, position 2 pairs with position 6, etc).

#### 4.4.5 Absorbance Filters

Place the filter (either a BMG-10 or an "Abs" filter) that matches the wavelength of choice in any excitation position. For emission, there are two possibilities:

Empty: Define a filter position as empty so that all the light from the reaction will pass directly through to the PMT ("empty" needs to be typed in).

Use of a filter: If you know the wavelength of the emitting light, you may choose to use a filter to block any stray light. The filter can be used in any emission filter position.

#### 4.4.6 Luminescence Filters

Like for fluorescence filters, the luminescence filters are designed to transmit as much light as possible. The bandwidth varies depending upon the type of assay (filters are optimized to return the best result) and can vary in the bandwidth from around 10 nm and up to to around 100 nm (measured at ½ height).

## 4.5 Spacers

The FLUOstar, POLARstar and LUMIstar OPTIMA are designed for most plate formats. The height of some microplates exceeds the space allowed under the optics. The minimum space between the optics and microplate should be 1.5 mm. With 6, 24, 48-well plate formats, it will be necessary to raise the optics using the spacers provided in the service box.

The spacers are metal rectangular pieces with a hole in the center. Each spacer is 2 mm in height. They fit between the measurement head and the optics. The number of spacers used depends on how high the optics needs to be elevated.

### Determination of the number of spacers:

If the height of the microplate exceeds the height of the left border of the plate carrier, (see figure 31) spacers need to be installed under the measurement head (see figure 32). There should be enough spacers so that the height of the left side of the plate carrier is slightly higher than the microplate.

3 spacers are needed in this example to make the height of the side of the plate carrier higher than the microplate



Figure 31: Front view of the plate carrier

### Installation of spacers:

If you install spacers, then first remove the injection needles (if any) from the optics and then remove the optics.

Install the appropriate number of spacers, using the positioning pins as a guide.

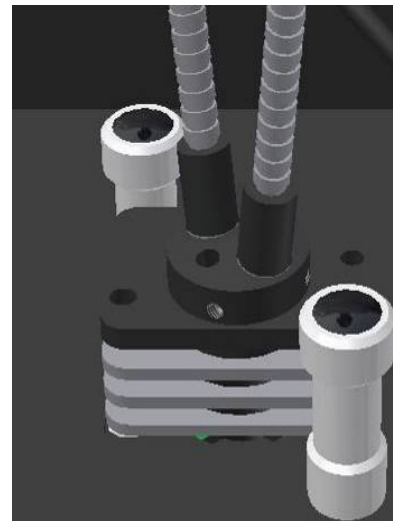

Figure 32: Example of spacers between measurement head and bottom of reagent box

As a cross check (to ensure that the microplate can pass under the optics), push the plate carrier manually into the instrument and slowly move it towards the optics. If there is approximately 1.5 to 2 mm of space between the optics and microplate, then enough spacers were installed.

## 4.6 Reagent Injectors

The FLUOstar, POLARstar as well as the LUMIstar OPTIMA can all be equipped with up to 2 reagent injectors (figure 33).

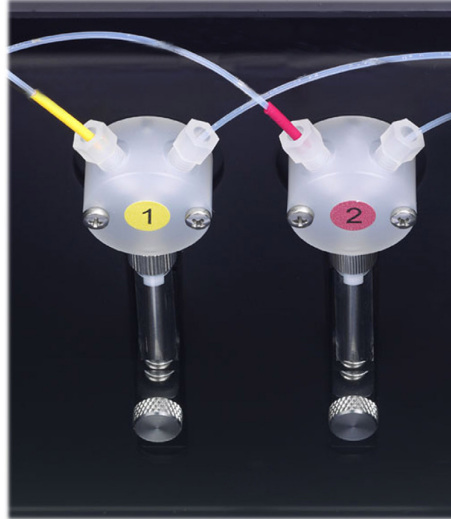

Figure 33: Reagent injectors

When the reagent injector(s) are not in use, the needle(s) can be placed in the needle holder (figure 8).

The reagent needles are made of stainless steel, the tubings and valve housing are made of Teflon and Kel-F, and the syringe barrel is made of glass. All materials are among the most chemical resistant materials available.

Of course, the needle tip plays a role regarding the pumps' accuracy. You should always treat the needles with care. That is, e.g. be careful when positioning the needles in the measurement head or in the needle holder.

For obtaining optimal performance of the reagent injectors, please see the following chapter.

### 4.6.1 Use and Maintenance of the Reagent Injectors

To remove cellular debris and viscous solutions from the syringe barrel:

Take off the syringe barrel and rinse it with distilled water. It may be useful to use the wire syringe cleaners (can be found in the service box) to scrape particles off the walls.

In order to obtain optimal performance from the reagent injectors, it is recommended to follow these guidelines in the use of the reagent injectors:

- **Do not use the syringes more than two cycles without liquid.**
- **After each use, thoroughly flush the syringes with distilled water.**
- **If the plunger is removed from the syringe barrel, it should be wiped with ethanol before replacing.**
- **Syringes should be cleaned each week using one of the following procedures:**
- **Cleaning with weak detergent or 10% bleach**
  1. Fill the syringe with a weak detergent or 10% bleach solution
  2. Leave the solution in the syringe for 30 minutes
  3. Flush the syringe a minimum of 10 times with distilled water
- **Cleaning with acid / base** (best procedure if cells are used in the syringe)
  1. Fill the syringe with 0.1M NaOH and leave it in the syringe for 10 minutes.
  2. Flush the syringe with distilled water.
  3. Fill the syringe with 0.1M HCl, and leave the solution in the syringe for 10 minutes.
  4. Flush the syringe a minimum of 10 times with distilled water.

## 5 Instrument Disinfection

Please follow all instructions carefully for a successful disinfection of the FLUOstar, POLARstar and LUMIstar OPTIMA.

All parts of the instrument, which have the possibility of contacting patient sera or positive samples, have to be handled as if they are hazardous. For this reason, it is recommended that gloves be worn while maintaining or working with the instrument.

It is very important that the instrument is thoroughly disinfected before maintenance or before removing the instrument from the laboratory. Be sure that the instrument is disinfected before you send it to your distributor or to the producer. For safety reasons, you have to fill out the Disinfection Certificate, or the instrument may not be accepted by the service centre or by customs authorities.

If the laboratory has no experience disinfecting the instrument, use the following solutions:

Alcohol 70%

Authorized personnel wearing disposable gloves and protective clothing should only perform the disinfection procedure. The location should be well ventilated.

Please note that formaldehyde may have influence on measurement results.

### Disinfection Steps

1. Disconnect the instrument from the main power supply.
2. Remove the RS232 cable from the connector.
3. Clean all outside surfaces of the instrument carefully with cotton wool, which has been soaked in formaldehyde solution.
4. Place the instrument in a large plastic bag along with the cotton wool that has been soaked in formaldehyde. Ensure that the wool does not touch the instrument.
5. Close and seal the bag.
6. Keep the instrument in the plastic bag for at least 24 hours.
7. After the disinfection time has lapsed, remove the instrument from the plastic bag and clean all outside surfaces of the instrument with cotton wool that has been soaked in alcohol solution.
8. Repeat the procedure for disinfection on any accessories, which will be returned with the instrument.
9. Complete the Disinfection Certificate.

# Disinfection Certification

This instrument and its inventory have never been in contact with any dangerous biological material, or if so, the instrument and its inventory have been disinfected according to the instructions of the operating manual of instrument.

Name: \_\_\_\_\_

Company: \_\_\_\_\_  
\_\_\_\_\_  
\_\_\_\_\_  
\_\_\_\_\_  
\_\_\_\_\_

Date, Signature: \_\_\_\_\_