SPECTRAmax[®] GEMINI XS

Dual-Scanning Microplate Spectrofluorometer Operator's Manual



Molecular Devices Corporation

1311 Orleans Drive
Sunnyvale, California 94089

Part # 0112-0059

Rev. A



Molecular Devices Corporation

SPECTRAmax® GEMINI XS Operator's Manual

Copyright

© Copyright 2000, Molecular Devices Corporation. All rights reserved. No part of this publication may be reproduced, transmitted, transcribed, stored in a retrieval system, or translated into any language or computer language, in any form or by any means, electronic, mechanical, magnetic, optical, chemical, manual, or otherwise, without the prior written permission of Molecular Devices Corporation, 1311 Orleans Drive, Sunnyvale, California, 94089, United States of America.

Patents

The SPECTRAmax GEMINI XS and methods have U.S. and International patents pending.

Trademarks

SPECTRAplate and AUTOMIX are trademarks and SPECTRAmax and SOFTmax are registered trademarks of Molecular Devices Corporation.

Cliniplate is a registered trademark of Labsystems.

DELFLIA is a registered trademark of Wallac Oy.

Emerald II is a trademark of Tropix, Inc.

All other company and product names are trademarks or registered trademarks of their respective owners.

Disclaimer

Molecular Devices Corporation reserves the right to change its products and services at any time to incorporate technological developments. This manual is subject to change without notice.

Although this manual has been prepared with every precaution to ensure accuracy, Molecular Devices Corporation assumes no liability for any errors or omissions, nor for any damages resulting from the application or use of this information.

Molecular Devices Corporation Instrument Warranty

Molecular Devices Corporation warrants this product against defects in material or workmanship as follows:

- 1) All parts of the SPECTRAmax GEMINI XS Microplate Spectrophotometer are warranted for a period of one (1) year from the original date of delivery.
- 2) All labor charges to repair the product for a period of one (1) year from the original date of delivery will be paid by Molecular Devices Corporation.
- 3) This warranty covers the SPECTRAmax GEMINI XS instrument only, and does not extend to any computer, printer, software, reagents, or disposables used with the instrument.



Labor and Parts

To obtain warranty service during the applicable warranty period, you must take the product or deliver the product properly packaged in the original shipping materials and carton to an authorized Molecular Devices Corporation service facility. You must call or write to the nearest Molecular Devices Corporation service facility to schedule warranty service. You may call Molecular Devices Corporation at the telephone number or address below to locate the nearest service facility. You must schedule warranty service **prior** to bringing or shipping the product for servicing. At the time of requesting warranty service, you must present proof of purchase documentation which includes the date of purchase and Molecular Devices Corporation must have the enclosed Warranty Registration form completed, signed and returned by you within ten (10) working days of the date of delivery.

This warranty only covers defects arising under normal usage and does not cover malfunctions of failures resulting from misuse, abuse, neglect, alteration, modification, or repairs by other than an authorized Molecular Devices Corporation service facility.

Repair or replacement as provided under this warranty is the exclusive remedy to the purchaser (the "Buyer"). **Molecular Devices Corporation (the "Seller") shall not be liable for any incidental or consequential damages for breach of any express or implied warranty on this product, except to the extent required by applicable law. The Seller specifically excludes all express and implied warranties including without limitation any implied warranty that the products sold under this agreement are merchantable or are fit for any particular purpose, except such warranties expressly identified as warranties and set forth in the Seller's current operating manual, catalog or written guarantee covering such product. The Seller also makes no warranty that the products sold under this agreement are delivered free of the rightful claim of any third party by way of patent infringement or the like.** If the Buyer furnishes specifications to the Seller, the Buyer agrees to hold the Seller harmless against any claim which arises out of compliance with the specifications.

Any description of the products contained in this agreement is for the sole purpose of identifying them. Any such description is not part of the basis of the bargain, and does not constitute a warranty that the products shall conform to that description. Any sample or model used in connection with this agreement is for illustrative purposes only, is not part of the basis of the bargain, and is not to be construed as a warranty that the products will conform to the sample or model. No affirmation of fact or promise made by the Seller, whether or not in this agreement, shall constitute a warranty that the products will conform to the affirmation or the promise.

For the name of the nearest authorized Molecular Devices Corporation service facility please contact Molecular Devices at one of the following telephone numbers:

(408) 747-1700

(800) 635-5577 (U.S. and Canada)

SPECTRA MAX GEMINI XS

Microplate Fluorometer

100-240V~ 4A 50-60 Hz  T4.0 A

2 lines fused. **Unplug before servicing!**
Vor Wartungsarbeiten Netzstecker ziehen!

 **Molecular Devices** Sunnyvale, CA
Made in USA





Contents

Figures	vii
Tables	vii
Conventions Used in this Manual	viii
Chapter 1: Instrument Description	1-1
Introduction.	1-3
Component Description	1-4
The Control Panel	1-5
The Microplate Drawer	1-6
The Optical System	1-7
The Back Panel	1-8
Principles of Operation	1-10
Theory of Operation	1-10
Time-Resolved Fluorescence	1-12
Luminescence.	1-12
Functional Description	1-13
Modes of Operation.	1-13
Temperature Regulation	1-14
Automix.	1-15
Computer Control.	1-15
Specifications	1-16
Glossary of Terms	1-18
Chapter 2: Installation	2-1
Installation Warnings.	2-3
Installation Cautions	2-3
Unpacking	2-3
Setting Up the Instrument	2-4
Installing the Drawer Adapter	2-4
Removing the Drawer Adapter.	2-6
Chapter 3: Operation	3-1
Prepare for a Reading.	3-3
Turn the Instrument and Computer On	3-3
Set the Temperature.	3-3
Read the Microplate.	3-4
Operation Overview.	3-4
Optimizing Assays	3-5
Introduction.	3-5
Using Spectral Scanning to Optimize Excitation and Emission Wavelengths for Fluorescence Assays.	3-6



Chapter 4: Maintenance	4-1
Technical Support	4-3
Cleaning.	4-3
Cleaning the Fan Filter	4-4
Changing the Fuses	4-4
Installing the Drawer Adapter	4-6
Removing the Drawer Adapter.	4-7
Moving the SPECTRAmax GEMINI XS.	4-7
Long-Term Shutdown	4-7
Chapter 5: Troubleshooting.	5-1
Error Codes and Resolutions	5-3
Opening the Drawer Manually	5-4
Appendix A: Cables and Accessories.	A-1
Cables	A-3
Items Available for Use with the SPECTRAmax GEMINI XS	A-3
Appendix B: Common Wavelengths	B-1
Fluorescence.	B-3
Time-Resolved Fluorescence	B-3
Luminescence.	B-4

**Figures**

Figure 1.1: SPECTRAmax GEMINI XS	1-4
Figure 1.2: Control Panel.	1-5
Figure 1.3: Microplate Drawer.	1-6
Figure 1.4: Components of the SPECTRAmax GEMINI XS Optical System	1-7
Figure 1.5: Components on the Back Panel of the SPECTRAmax GEMINI XS	1-8
Figure 1.6: Excitation and Emission Spectra	1-10
Figure 1.7: Optimized Excitation and Emission Reading Wavelengths	1-11
Figure 2.1: View of Rear Panel.	2-4
Figure 3.1: Plot of RFU vs. Wavelength.	3-7
Figure 3.2: Effects of Cutoff Filters on Fluorescein.	3-8
Figure 4.1: Power Switch, Fuse Box, and Power Receptacle	4-5
Figure 4.2: Removing the Fuse Box	4-5
Figure 4.3: The Fuse Box and Holder (with Fuses) Removed.	4-6

Tables

Table 3.1: Emission Cutoff Filter Default Settings.	3-9
Table 5.1: Error Codes and Resolution	5-3



Conventions Used in this Manual

The names of keys that appear on the SPECTRAmax GEMINI XS control panel are shown in boxed Helvetica type. Example: **Setup**.

Italic and boldface type are used for emphasis. Examples: “Press *carefully* to engage,” “**Do not press down.**”

NOTE: A note provides information that will help you properly execute an action or procedure.

CAUTION: Indicates an action or condition that could potentially damage the instrument or one of its components or could result in loss of data.

WARNING: Indicates a situation that could result in potential injury to a person working with the system.

BIOHAZARD: Indicates a condition involving potentially infectious biological agents requiring that proper handling precautions be taken.

Chapter 1: Instrument Description

Introduction.	1-3
Component Description	1-4
The Control Panel	1-5
The Microplate Drawer	1-6
The Optical System	1-7
The Back Panel	1-8
Principles of Operation	1-10
Theory of Operation	1-10
Time-Resolved Fluorescence	1-12
Luminescence.	1-12
Functional Description	1-13
Modes of Operation.	1-13
Temperature Regulation	1-14
Automix.	1-14
Computer Control.	1-15
Specifications	1-16
Glossary of Terms	1-18





Introduction

The SPECTRAmax™ GEMINI XS Dual-Scanning Microplate Spectrofluorometer can perform a variety of fluorescent applications as well as some time-resolved fluorescent and luminescent assays. The extreme flexibility and high sensitivity of the SPECTRAmax GEMINI XS make it appropriate for applications within the fields of biochemistry, cell biology, immunology, molecular biology, and microbiology.

The SPECTRAmax GEMINI XS uses two holographic diffraction grating monochromators which allow for individual optimization of wavelengths for both excitation and emission. The dual-scanning capability can also be used to determine excitation and emission settings for new fluorescent probes. Mirrored optics focus the light into the sample volume and cutoff filters are used to reduce stray light and minimize background interference. The light source is a high-powered Xenon flashlamp; additional flexibility is provided by allowing a variable number of lamp flashes per read.

Microplates having 6, 12, 24, 48, 96, and 384 wells can be used in the SPECTRAmax GEMINI XS. Fluorescent detection is achieved from the top, through the entire depth of sample in the microplate well. Detection of species collected on membrane plates is also possible.

Two plate carrier adapters are provided with the instrument. The blue adapter is required for optimum performance with standard 96- and 384-well format microplates. The red adapter has been optimized for use with Cliniplate 384 microplates.

The dynamic range of detection is from 10^{-6} to 10^{-11} molar fluorescein. Variations in measured fluorescence values are virtually eliminated by internal compensation for detector sensitivity, photomultiplier tube voltage and sensitivity, as well as excitation intensity.

Temperature in the microplate chamber is isothermal, both at ambient and when the incubator is turned on. When the incubator is on, the temperature may be controlled from 4°C above ambient to 45°C.

The contents of the wells in a microplate can be mixed automatically by shaking before each read cycle, which makes it possible to perform kinetic analysis of solid-phase, enzyme-mediated reactions such as a kinetic ELISA.

The SPECTRAmax GEMINI XS is controlled by an external computer running SOFTmax® PRO software which provides integrated instrument control, data display, and statistical data analysis. The SPECTRAmax GEMINI XS cannot be operated without the computer and SOFTmax PRO software.



Component Description

The main components of the SPECTRAmax GEMINI XS described in this manual are:

- The control panel
- The microplate drawer
- Optical system
- The back panel (connections and power switch)



Figure 1.1: SPECTRAmax GEMINI XS

The Control Panel

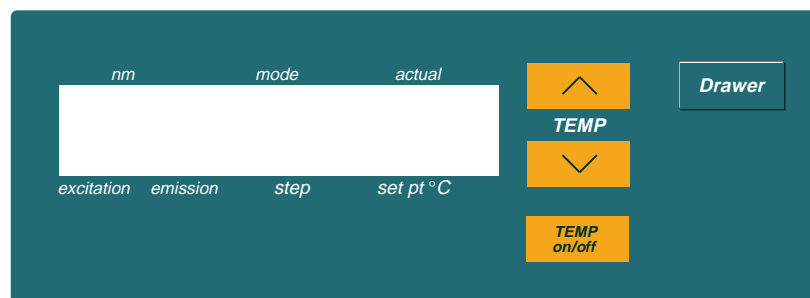

Figure 1.2: Control Panel

The control panel consists of an LCD and four pressure-sensitive membrane keys which can be used to initiate and regulate the temperature and to open/close the drawer. When you press a control panel key, the SPECTRAmax GEMINI XS performs the desired action.

LCD

A 2- \times -20-character liquid crystal display which shows the current instrument settings.



Keys

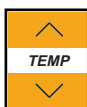

Allows you to enter a set point at which to regulate the microplate chamber temperature. Pressing this key scrolls the temperature up or down, starting at the previous temperature setting (or the default of 37.0°C, if no setting had been made). Pressing the up (▲) or down (▼) arrow *once* increments or decrements the temperature shown in the display by 0.1°C; pressing and holding either arrow increments or decrements the temperature shown in the display by 1°C until it is released. If you increment the setting to the highest limit (45°C) and continue to press the up (▲) arrow, the display will not change. If you decrement the setting to the lowest limit, 15°C, and continue to press the down (▼) arrow, the display will not change.



Enables/disables the incubator function. When the incubator is on, the set temperature and actual temperature are shown on the front panel LCD display.

NOTE: When the instrument is performing a kinetic or spectral scan, the temperature keys on the front panel are disabled.



Opens or closes the microplate drawer. Whether or not the drawer will remain open depends on the incubator setting. If the incubator is off, the drawer will remain open; if the incubator is on, the drawer will close after approximately 10 seconds to assist in maintaining temperature control within the microplate chamber.

NOTE: To add reagents during a kinetic read, it is necessary to open the drawer by pressing the **Drawer** key. The drawer will only open, however, if the interval between readings is equal to the minimum read interval originally shown by SOFTmax PRO software *plus an additional 45 seconds*. If you plan to open the drawer during a kinetic read, first determine the minimum read interval allowed and then increase the setting by a minimum of 45 seconds. The drawer will close automatically after this interval before the next read.



The Microplate Drawer

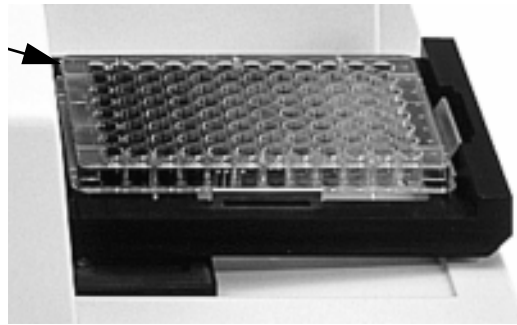

Figure 1.3: Microplate Drawer

The microplate drawer, located on the right side of the SPECTRAmax GEMINI XS, slides in and out of the microplate chamber. Springs on two sides of the drawer automatically position and hold a microplate in the proper position. The drawer remains in the reading chamber during read cycles.

Two plate carrier adapters are provided with the instrument. The blue adapter is required for optimum performance with standard 96- and 384-well format microplates. The red adapter has been optimized for use with low-profile Cliniplate 384 microplates.

NOTE: The adapter must be removed to read 6-, 12-, 24-, or 48-well plates.

Microplate drawer operation varies, depending upon the incubator status. When the incubator is off, the microplate drawer remains open at power up and after a read. When the incubator is on, the drawer closes automatically to assist in controlling the temperature of the microplate chamber. To open the drawer, press the **Drawer** key. The drawer will remain open for approximately ten seconds, after which a beeping sound will alert you approximately two seconds before the drawer closes automatically. (The drawer will remain open longer during intervals set for adding reagents during kinetic reads—see the NOTE on page 1-5).

NOTE: Do not obstruct the movement of the drawer. If you must retrieve a plate after an error condition or power outage and the drawer will not open, it is possible to open it manually (see Chapter 5, “Troubleshooting”).

Microplates

The SPECTRAmax GEMINI XS can accommodate standard 6-, 12-, 24-, 48-, 96-, and 384-well microplates. Black-walled, clear-bottom or all black microplates are generally recommended for fluorescence assays because they have lower backgrounds than clear plates. White plates may be preferred for luminescence assays to optimize light collection.

Not all manufacturers’ microplates are the same with regard to design, materials, or configuration. Some plastics, most notably polystyrene, also have significant native fluorescence and can cause moderate to severe background fluorescence, especially in the UV range. If high sensitivity is required, it may be appropriate to use microplates that are designed to reduce background fluorescence.



The Optical System

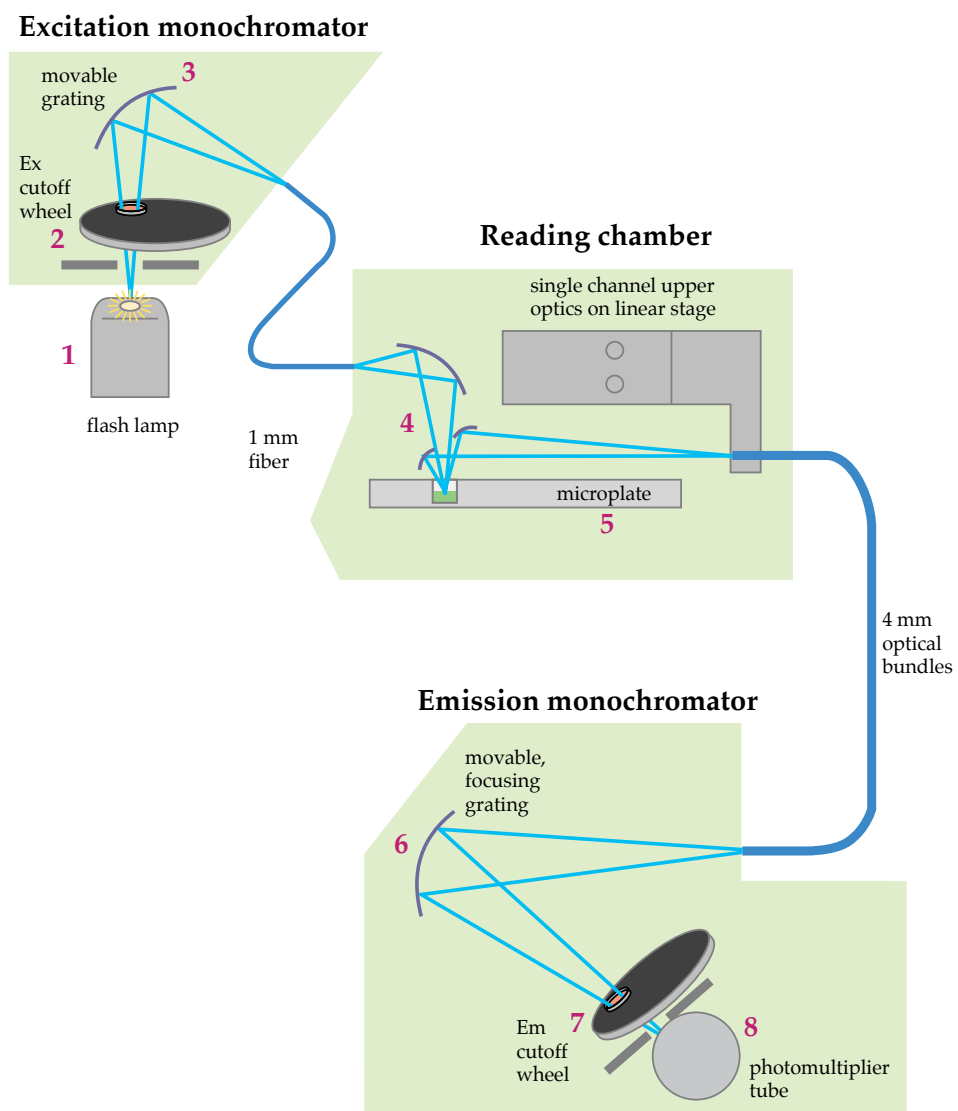

Figure 1.4: Components of the SPECTRAmax GEMINI XS Optical System

- 1) The excitation light source is a xenon flashlamp. (Note that the lamp is off when luminescence mode is selected.)
- 2) The light passes through a band-pass filter which reduces the amount of stray light to the excitation monochromator.
- 3) The holographic diffraction grating monochromator selects the desired excitation wavelength.
- 4) The excitation beam is collimated by a mirror to a 1.0-mm diameter fiber before entering the sample in the microplate well. This focusing helps to prevent part of the beam from striking adjacent wells.



- 5) The light beam enters the well and, if fluorescent molecules are present, light of the emission wavelength is emitted back out to mirrors that focus it and send it to an optical bundle.
- 6) The emission monochromator (also a holographic diffraction grating monochromator) allows light of the chosen emission wavelength to pass to the emission filter wheel.
- 7) A long-pass filter further conditions the light prior to detection by the photomultiplier tube (PMT). This filter may be set automatically by the instrument or manually by the user.
- 8) The PMT detects the emitted light and passes a quantitative signal to the instrument's electronics which then send the data to the computer.

The Back Panel

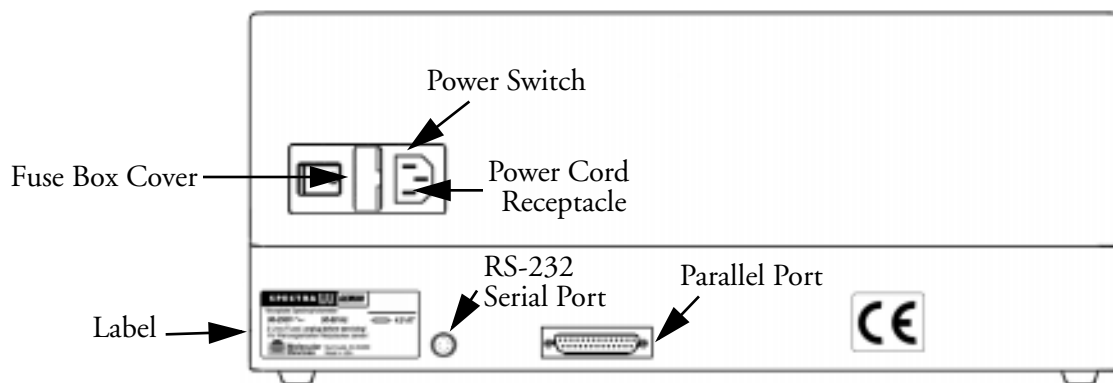

Figure 1.5: Components on the Back Panel of the SPECTRAmax GEMINI XS

The following components are located on the back panel of the SPECTRAmax GEMINI XS:

- **Power switch:** a rocker switch, labeled I/O (for on and off, respectively).
- **Power cord receptacle:** plug the power cord in here.
- **Fuse box cover:** cannot be opened while the power cord is plugged in. When opened, it provides access to the fuse box containing two fuses that are required for operation.
- **Printer port:** Present but not used in this model of SPECTRAmax.
- **Serial port** (double-shielded RS-232, for use with an external computer): plug one end of an 8-pin DIN serial cable into this port; the other end attaches to the serial (modem) port of the computer.
- **Labels:** provide information about the SPECTRAmax GEMINI XS, such as line voltage rating, cautionary information, serial number, etc. Record the serial number shown on this label for use when contacting Molecular Devices Technical Services.



Principles of Operation

Theory of Operation

Fluorescent materials absorb light energy of a characteristic wavelength (excitation) undergo an electronic state change, and instantaneously emit light of a longer wavelength (emission). Most common fluorescent materials have well-characterized excitation and emission spectra. Figure 1.6 shows an example of excitation and emission spectra for a fluorophore. The excitation and emission bands are each fairly broad, with half-bandwidths of approximately 40 nm, and the wavelength difference between the excitation and emission maxima (the Stokes shift) is typically fairly small, about 30 nm. Exceptions to this rule are the lanthanide dyes used in time-resolved fluorescence: they have a Stokes shift that is typically about 50 nm. There is considerable overlap between the excitation and emission spectra (gray area) when a small Stokes shift is present.

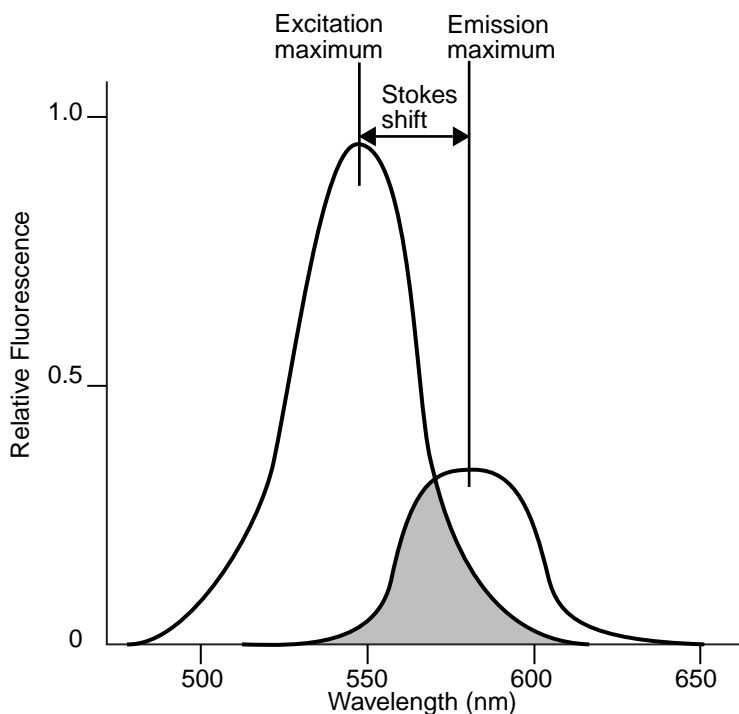

Figure 1.6: Excitation and Emission Spectra

Because the intensity of the excitation light is usually many tens of thousands of times greater than that of the emitted light, some type of spectral separation is necessary to reduce the interference of the excitation light with detection of the emitted light. The SPECTRAmax GEMINI XS incorporates many features designed to restrict interference from reflected excitation light. Among these features is a set of band-pass cutoff filters that may be set automatically by the instrument or manually by the user. If the Stokes shift is small, it may be advisable to choose an excitation wavelength that is as far away from the emission maximum as possible while still being capable of stimulating the fluorophore so that less of the excited light will overlap the emission spectrum, allowing better selection and quantitation of the emitted light.

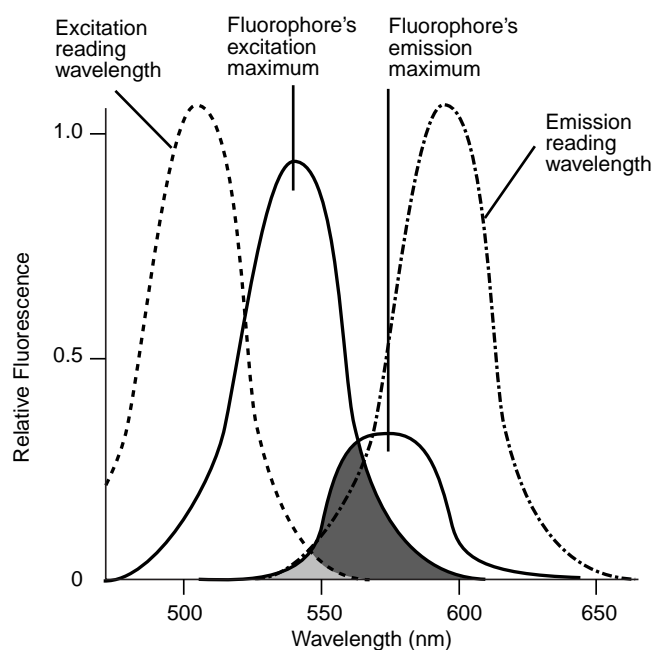

Figure 1.7: Optimized Excitation and Emission Reading Wavelengths

Figure 1.7 shows that the best results are often obtained when the excitation and emission wavelengths used for reading are not the same as the wavelengths of the excitation and emission spectra of the fluorophore. When the reading wavelengths for excitation and emission are separated, a smaller amount of excitation light will pass through to the emission monochromator (gray area) and on to the PMT, resulting in a purer emission signal and more accurate data.

The SPECTRAmax GEMINI XS allows scanning of both excitation and emission wavelengths, using separate tunable monochromators. One benefit of being able to scan emission spectra is that you can assess more accurately whether the emission is, in fact, the expected fluorophore, or multiple fluorophores, and not one generated by a variety of background sources or by contaminants. Another benefit is that, if interfering fluorescent species are present, you may be able to find excitation and emission wavelengths that avoid interference.

For this reason, it may be desirable to scan emission for both an intermediate concentration of labeled sample, as well as the background of unlabeled sample. The optimum setting is where the ratio of the sample emission and background emission is at the maximum.

For more information regarding optimizing excitation and emission wavelengths using the spectral scanning capabilities of the SPECTRAmax GEMINI XS, please see “Optimizing Assays” on page 3-5.



Time-Resolved Fluorescence

In normal fluorescence mode, readings are taken while the lamp is on. The most common limitation to sensitivity in normal fluorescence is excitation energy or background fluorescence that cannot be eliminated from the emission signal. Since the lamp is the source of excitation energy, turning it off provides the best means of eliminating background excitation.

Time-resolved fluorescence is performed by flashing the excitation lamp and, after it is off, collecting the delayed emission for a period of time before the lamp is flashed again. Lanthanide dyes are frequently used to delay the fluorescence long enough to measure it after the lamp is turned off.

To assist with proper collection of data, you can also select when to start and end data collection (within the limits of the system—the minimum is 50 μ sec and the maximum is 1450 μ sec in 200- μ sec steps).

Luminescence

In luminescence mode, no excitation is necessary as the species being measured emit light naturally. For this reason, the lamp does not flash, so no background interference occurs. A dark estimate is done over a dark reference and multiple readings are averaged together into one reading per well.

You can choose the wavelength where peak emission is expected to occur. In addition, multiple wavelength choices allow species with multiple components to be differentiated and measured easily. In luminescence read mode, no emission cut-off filter is used. The default setting for luminescence is the “zero order” position where the grating monochromator acts as a mirror which reflects all light to the PMT detector.

The GEMINI XS is a microplate spectrofluorometer with photomultiplier tube detection. Some luminescence applications like gene reporter assays may require a luminometer with photon counting detection for greater sensitivity.



Functional Description

The SPECTRAmax GEMINI XS is designed to be operated using SOFTmax PRO software running on a computer connected to the instrument. Stand-alone functions are limited to setting and enabling temperature control and opening or closing the microplate drawer.

The information contained in this section provides an overview of the instrument capabilities. For a complete description of the modes of operation, how to choose instrument settings, etc., refer to the *SOFTmax PRO User's Manual*.

Modes of Operation

The SPECTRAmax GEMINI XS can perform three types of readings: fluorescence as well as some luminescence and time-resolved fluorescence applications. Within each read type, the SPECTRAmax GEMINI XS can perform four modes of operation: endpoint, kinetic, spectrum, and well scanning. Instrument setup parameters for each read mode are discussed in the *SOFTmax PRO User's Manual*.

Endpoint Mode

Select from one to four excitation/emission pairs in endpoint mode to obtain fluorescent (RFU), luminescent (RLU), or time-resolved fluorescent (RFU) readings for each well of a microplate. Endpoint data is reported as RFU/wavelength or RLU/wavelength.

Kinetic Mode

Kinetic analysis can be performed for up to 99 hours. The kinetic read interval depends upon the instrument setup parameters chosen in SOFTmax PRO. At the end of a reading, rates are reported as RFU/second or RLU/second for each well.

Kinetic analysis has many advantages when determining the relative activity of an enzyme in different types of microplate assays, including ELISAs and the purification and characterization of enzymes and enzyme conjugates. Kinetic analysis is capable of providing improved dynamic range, precision, and sensitivity relative to endpoint analysis.

Spectrum Mode

Spectral analysis measures fluorescence or luminescence across a spectrum of wavelengths (minimum 250 nm; maximum 850 nm). When reading using fluorescence or time-resolved fluorescence, you may set a fixed wavelength for excitation and scan the emission wavelengths, and vice versa. The default value reported for each well is the wavelength of maximum fluorescence. When luminescence is chosen, only the emission wavelengths are scanned, and the default value reported for each well is the wavelength of maximum luminescence.

All spectrum readings are made using the scanning monochromators of the SPECTRAmax GEMINI XS.



Well Scanning Mode

Some applications that involve the detection of whole cells in large-area tissue culture plates may require the use of well scanning mode. As many cell lines tend to grow in clumps or in the corner of microplate wells, this non-confluent growth pattern may require multiple reads in a well at different locations.

When used with 6-, 12-, 24-, 48-, or 96-well plates, well scanning allows maximum surface area detection for whole cell assays. No plate adapter is required when using large-area tissue culture plates. For more information on well scanning, please review the appropriate section in the *SOFTmax PRO User's Manual*.

Temperature Regulation

The SPECTRAmax GEMINI XS has been designed to regulate the temperature of the microplate chamber from 4°C above ambient to 45°C. Upon power up, when the incubator is off, the temperature in the SPECTRAmax GEMINI XS microplate chamber is ambient and isothermal. Turning on the incubator by pressing the **Temp on/off** (incubator) key will cause the SPECTRAmax GEMINI XS to begin warming the microplate chamber. The temperature set point defaults to 37.0°C at start-up. With the incubator on, the temperature of the microplate chamber can be set and regulated from 4°C above ambient to 45°C.

NOTE: Accuracy of the temperature set point is only guaranteed if the set point is at least 4°C above ambient. If the temperature set point is lower than the ambient temperature, the chamber temperature will remain at ambient. Temperature regulation is controlled by heaters only and, therefore, cannot cool the temperature to a setting lower than ambient. Additionally, the highest setting (45°C) can be achieved only if the ambient temperature is >20°C.

You can change the temperature set point by pressing the up (Λ) or the down (∨) arrow keys until the desired set point is shown above the key in the display.

Typically, the microplate chamber will reach 37.0°C in less than 30 minutes. The microplate chamber temperature is maintained at the set point until you press the incubator **Temp on/off** key again, turning temperature regulation off.

NOTE: Should you turn the incubator back on after a momentary shutdown, allow about ten minutes for the control algorithm to fully stabilize the microplate chamber temperature.

Temperature regulation and control of the microplate chamber is achieved through electric heaters, a fan, efficient insulation, and temperature sensors. The heaters are located in the microplate chamber which is insulated to maintain the temperature set point. The sensors are mounted inside the chamber and measure the air temperature.

The temperature feedback closed-loop control algorithms measure the chamber air temperature, compares it to the temperature set point, and use the difference to calculate the regulation of the heating cycles. This technique results in accurate, precise control of the microplate chamber temperature with a temperature



variation of the air across the entire microplate of less than 0.5°C. (Temperature uniformity within the microplate itself will depend upon its design, materials, and/or configuration.)

Automix

The Automix function permits automatic shaking of the microplate at preset intervals, thereby mixing of the contents within each well. Automix must be selected before beginning a reading. The actions associated with the Automix setting depends on the read mode chosen.

For endpoint mode, enabling Automix will shake the plate for a definable number of seconds and then read at all selected wavelengths.

When kinetic mode is chosen, two types of Automix can be enabled: you can set Automix to shake the plate for a definable number of seconds before the initial reading and/or for a definable number of seconds before each subsequent reading.

NOTE: Use of Automix is strongly recommended for ELISAs and other solid-phase, enzyme-mediated reactions to enhance accuracy.

Computer Control

The SPECTRAmax GEMINI XS is equipped with an 8-pin DIN RS-232 serial port through which the computer communicates with and controls the instrument (different types of cables are available for connecting to different types of computers—see Appendix A, “Cables and Accessories”). SOFTmax PRO software, version 3.1 or greater, is required to control the SPECTRAmax GEMINI XS.



Specifications **NOTE:** Technical specifications are subject to change without notice.

Fluorescence Photometric Performance

Wavelength range (Excitation/Emission)	250–850 nm
Wavelength selection	Scanning monochromator tunable in 1-nm increments
Wavelength bandwidth	9 nm
Wavelength accuracy	$< \pm 2.0$ nm
Calibration	Self calibrating with built-in fluorescence calibrators
Sensitivity (signal 3X STD DEV of baseline)	2.0 fmol/well FITC

Time-Resolved Fluorescence Photometric Performance

Data collection	50–1450 μ sec
Integration start/end	User selectable in 200- μ sec intervals
Sensitivity (signal 3X STD DEV of baseline)	0.5 fmol/well Eu-chelate (obtained with DELFIA reagent from Wallac Oy using a 384-well plate)

Luminescence Photometric Performance

Wavelength range	250–850 nm
Sensitivity (signal 3X STD DEV of baseline)	10 amol/well Alkaline Phos. (obtained with Emerald II reagent from Tropix, Inc.)

General Photometric Performance

Microplate formats	6, 12, 24, 48, 96, 384
Light source	Xenon flash lamp (1 joule/flash)
Average lamp lifetime	2 years normal operation (estimate)
Detector	Photomultiplier (R-3896)
Read time	96 wells in <27 seconds (measurement type may extend read time)
Dynamic range	6 decades in 96-well black plates; auto PMT circuitry
Shaker	Time 0–999 seconds
Temperature control (chamber)	Ambient +4°C to 45°C



General Photometric Performance *(continued)*

Sample evaporation control	90% RH compartment
Sample temperature uniformity (including evaporative)	0.5°C @ 37°C (well to well)
Ramp up to 37°C	<30 minutes

System Validation

Internal standards for fluorescence and wavelength

Software

Windows 95/98/NT/2000 compliant
Macintosh OS FAT

Environmental

Robot ready	Yes
Turn-on time	<5 min. to rated accuracy
Operating conditions	15 to 40°C
Operating humidity	0 to 90% RH non-condensing
Storage temperature	-20 to 65°C

Physical

Size (h × w × d)	13.5" (340 mm) × 16.5" (420 mm) × 16.5" (420 mm)
Weight	35 lb (16 kg)
Power consumption	230 VA maximum
Line voltage and frequency	90–240 VAC, 50/60 Hz



Glossary of Terms

Automix

The Automix function determines how often, if at all, automated shaking of the microplate is performed during a reading. This feature is covered by U.S. Patent Number 5,112,134.

Cutoff

A filter used to condition the light entering or exciting the monochromators. In automatic mode, the instrument sets the cutoffs automatically based upon the wavelength(s) chosen for reading; with some read modes and types, however, you can choose a different filter wavelength (manual setting) for the emission monochromator.

Endpoint

A single reading made at one or more excitation/emission wavelengths.

Emission Spectral Scan

Measures fluorescence or luminescence across a spectrum of wavelengths for emitted light. The default value reported for each well is the wavelength of maximum fluorescence or luminescence.

Excitation Spectral Scan

Measures fluorescence at a single emission wavelength across a spectrum of excitation wavelengths. The default value reported for each well is the excitation wavelength of maximum fluorescence.

Fluorescence

The light emitted by certain substances resulting from the absorption of incident radiation. To measure fluorescence accurately, it is necessary to reduce light scatter. The governing equation for fluorescence is:

$$\text{Fluorescence} = \text{extinction coefficient} * \text{concentration} * \text{quantum yield} * \text{excitation intensity} * \text{pathlength} * \text{emission collection efficiency}$$

Fluorophore

A material which absorbs light energy of a characteristic wavelength, undergoes an electronic state change, and instantaneously emits light of a longer wavelength.

Gain

The amount of increase in signal power expressed as the ratio of output to input.

Incubator

Choosing **Incubator** from the **Control** menu or clicking the incubator button opens a dialog box allowing you to start or stop temperature regulation and to select an elevated temperature for the microplate chamber.



Instrument Setup

(In SOFTmax PRO software) Defines the parameters (mode, wavelengths, automatic mixing, run time, read interval, etc.) used to read the microplate.

Kinetic

During kinetic readings, data is collected over time, with multiple readings made at regular intervals. The values calculated based on raw kinetic data are Vmax, Time to Vmax, and Onset Time. Kinetic readings can be single- or multiple-wavelength readings.

LCD (Liquid Crystal Display)

A 2-x-20-character display which shows the current instrument settings.

Luminescence

The emission of light by processes that derive energy from essentially nonthermal changes, the motion of subatomic particles, or the excitation of an atomic system by radiation.



Parallel Port (Windows)

A connection on a computer, usually LPT1, where you plug in the cable for a parallel printer. Windows supports parallel ports LPT1 through LPT3.

Photomultiplier Tube (PMT)

A vacuum tube that detects light especially from dim sources through the use of photoemission and successive instances of secondary emission to produce enough electrons to generate a useful current.

Read Mode

The method used to read the microplate: endpoint, kinetic, spectrum, or well scan.

Read Type

The type of reading performed: fluorescence, time-resolved fluorescence, or luminescence.

Readings per Well

The number of times (settable by the user) that readings are taken on a well in fluorescence and time-resolved fluorescence modes. This setting also determines the amount of time that data is collected using the luminescence read type.

SOFTmax PRO

An integrated software program (from Molecular Devices Corporation) that is used to control and collect data from the SPECTRAmax GEMINI XS instrument.

Stokes Shift

The difference between the wavelengths of the excitation and emission peaks.



Time-Resolved Fluorescence

Most fluorescence substances are not suitable for this type of reading. However, the fluorescence emitted by lanthanide dyes is delayed long enough to measure fluorescence after the lamp is turned off. Time-resolved fluorescence is used to reduce the amount of background noise which interferes with fluorescence. The excitation lamp flashes and, after it is off, the delayed emission is collected for a set period of time before the lamp is flashed again.



Chapter 2: Installation

Installation Warnings.....	2-3
Installation Cautions	2-3
Unpacking.....	2-3
Setting Up the Instrument.....	2-4
Installing the Drawer Adapter	2-4
Removing the Drawer Adapter.....	2-6





Installation Warnings

- 1) Always make sure the power switch on the instrument is in the OFF position and remove the power cord from the back of the instrument prior to any installation or relocation of the instrument.
- 2) Do not operate the instrument in an environment where potentially damaging liquids or gases are present.

Installation Cautions

Do not touch or loosen any screws or parts other than those specifically designated in the instructions. Doing so might cause misalignment and will void the instrument warranty.

Unpacking

The SPECTRAmax GEMINI XS is packed in a specially designed carton. Please retain the carton and the packing materials. If the unit should need to be returned for repair, you must use the original packing materials and carton for shipping. If the carton has been damaged in transit, it is particularly important that you *retain it for inspection by the carrier in case there has also been damage to the instrument.*

⚠ WARNING: The SPECTRAmax GEMINI XS weighs approximately 35 pounds (16 kg) and should be lifted with care. It is recommended that two persons lift the instrument together, taking the proper precautions to avoid injury.

After examining the carton, place it on a flat surface in the upright position. Open the top of the box and lift the SPECTRAmax GEMINI XS, along with the packing materials around the ends, up and out of the shipping box. Remove the packing material from both ends of the instrument and set the instrument down carefully. The packing list that accompanies the instrument describes all components that should have been placed in the packing carton. Make sure all these items are present before proceeding.



Setting Up the Instrument

- 1) Place the SPECTRAmax GEMINI XS on a *level surface, away from direct sunlight, dust, drafts, vibration, and moisture.*
- 2) Turn the instrument around so that the back of the instrument is facing you as shown in Figure 2.1.

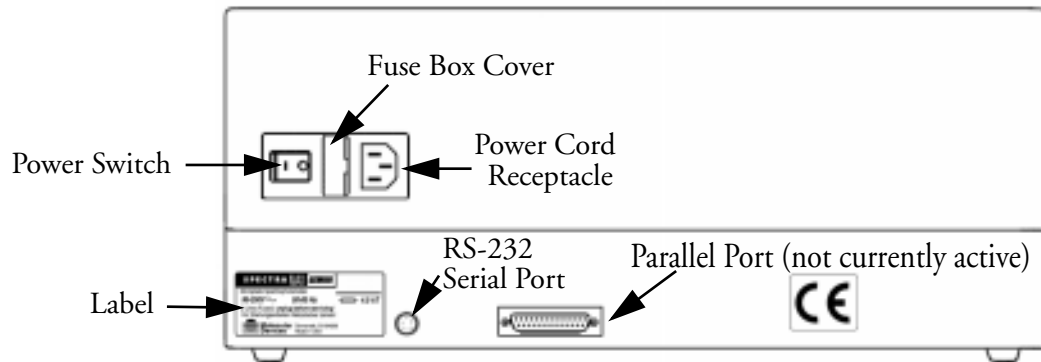

Figure 2.1: View of Rear Panel

- 3) Insert the female end of the power cord into the power receptacle at the rear of the SPECTRAmax GEMINI XS. Connect the male end to a grounded power outlet of the appropriate voltage. Molecular Devices recommends that you use a surge protector between the power cord and the grounded power outlet.
- 4) Insert the 8-pin DIN round end of the computer connection cord into the RS-232 serial port receptacle on the back panel of the instrument. Attach the other end to your computer (see Appendix A for more information).
- 5) Turn the SPECTRAmax GEMINI XS around so that the control panel now faces you. Be sure no cables run beneath the instrument. Leave at least three inches between the back of the instrument and the nearest objects or surfaces to ensure proper ventilation and cooling.

Installing the Drawer Adapter

If you are reading standard 96-well or 384-well microplates, you will need to install a drawer adapter. Two plate carrier adapters are provided with the instrument. The blue adapter is required for optimum performance with standard 96- and 384-well format microplates. The red adapter has been optimized for use with Cliniplate 384 microplates. Both adapters are included in the instrument accessory kit.

⚠ CAUTION: Incorrect insertion or removal of either adapter may cause damage to the microplate drawer of the SPECTRAmax GEMINI XS.

- 1) Turn power to the instrument on.
- 2) Press the **Drawer** button on the front panel or activate the drawer open command in SOFTmax PRO software.
- 3) Hold the adapter so that the label is on the left side facing up.
- 4) Place the top back (Row A) portion of the adapter into the drawer first. While pushing against the back edge of the adapter, lower the front of the adapter into the drawer.



Removing the Drawer Adapter

If you are reading “high profile” (6-, 12-, 24-, or 48-well) plates and the adapter is in the drawer, you will need to remove the adapter.

⚠ CAUTION: Incorrect insertion or removal of the adapter may cause damage to the microplate drawer of the SPECTRAmax GEMINI XS.

- 1) Turn power to the instrument on.
- 2) Press the **Drawer** button on the front panel or activate the drawer open command in SOFTmax PRO software.
- 3) Hold the adapter at the front (long side of the drawer) and push toward the back (Row A).
- 4) Lift the front (Row H) of the adapter and remove it from the drawer.



Chapter 3: Operation

Prepare for a Reading	3-3
Turn the Instrument and Computer On	3-3
Set the Temperature	3-3
Read the Microplate	3-4
Operation Overview	3-4
Optimizing Assays	3-5
Introduction	3-5
Using Spectral Scanning to Optimize Excitation and Emission Wavelengths for Fluorescence Assays	3-6





This chapter contains operating information for the SPECTRAmax GEMINI XS Dual-Scanning Microplate Fluorometer. If you are an experienced user of this instrument, a quick review of the operating steps may be found on page 3-4.

Prepare for a Reading

Turn the Instrument and Computer On

The power switch for the SPECTRAmax GEMINI XS is located on the back panel. Press the rocker switch to the on position. The instrument will automatically perform diagnostic checks to ensure that it is functioning correctly. Turn the computer on at this time also and start the SOFTmax PRO software program.

Set the Temperature

If elevated temperature within the microplate chamber is desired, you should turn on the incubator first, allowing enough time for the temperature to reach the set point before performing a reading. When you first turn the instrument on, up to 30 minutes may be required for the temperature within the chamber to reach the set point. Turning on the incubator and choosing a temperature set point can be done using the software or the front panel of the instrument (described here).

NOTE: Temperature cannot be regulated at a set point that is lower than 4°C above the ambient temperature.

To enable the incubator, press the incubator Temp on/off key. The LCD display will indicate that temperature control is on and will show the set point and current temperature of the microplate chamber.

To change the temperature set point, press the up or down arrow keys until the desired temperature set point is shown in the display.

The microplate chamber temperature will be maintained at the set point until you disable temperature control by touching the incubator key again. When the incubator is off, the temperature within the microplate chamber will begin returning to ambient.

NOTE: Should you turn the incubator back on after a momentary shutdown, allow about ten minutes for the control algorithm to fully stabilize the microplate chamber temperature.



Read the Microplate

⚠ **BIOHAZARD:** The underside of the microplate must be dry prior to placing it in the drawer. If the microplate has fluid on the underside, dry it using a paper towel (or equivalent) before placing it in the drawer.

Insert the filled microplate into the drawer, matching well A1 with position A1 in the drawer. Make sure the microplate is flat against the drawer bottom (for 6-, 12-, 24-, or 48-well microplates) or against either the red or blue adapter (if using 96- or 386-well plates—see “Installing the Drawer Adapter” on page 2-4 for more information).

You must use SOFTmax PRO software running on a computer (properly connected to the SPECTRAmax GEMINI XS) in order to perform instrument setup, reading, and to analyze the data that is collected.

When reading is complete, the drawer of the instrument will open, allowing you to remove the microplate. If the incubator is on, the drawer will close again after approximately 10 seconds. If you return to the SPECTRAmax GEMINI XS and find the drawer closed after a reading has finished, press the **Drawer** key. When the drawer opens, you may remove the microplate.

Operation Overview

The following steps provide a quick reminder of the basic operating procedures required to perform an assay using the SPECTRAmax GEMINI XS.

- 1) Turn on the power switch of the SPECTRAmax GEMINI XS (located on the back panel). The microplate drawer will open automatically.
- 2) If you wish to regulate the temperature inside the microplate chamber, touch the **Temp on/off** (incubator) key to turn the incubator on and bring the microplate chamber to the default temperature of 37.0°C. The microplate drawer will close.
- 3) If the incubator is on, the LCD will show the current temperature along with the temperature set point. To change the set point (to any setting from ambient +4° to 45°C), press the up or down arrow keys.
- 4) Select the desired instrument settings (read mode, type of analysis, template, etc.) using SOFTmax PRO software on the external computer.
- 5) If you are performing kinetic analysis, add substrate at this time.
- 6) Load the prepared microplate into the drawer, being sure to match well A1 with the A1 mark on upper left-hand corner of the drawer.
- 7) Using SOFTmax PRO, start the reading.



Optimizing Assays

Introduction

The optimum instrument settings for detection of a particular fluorophore depend on a number of different factors. Settings that can be adjusted for assay optimization include the excitation and emission wavelengths, emission cutoff filter, readings per well, the PMT voltage, the temperature of the reading chamber, and the length of delay time for time-resolved fluorescence.

- The excitation and emission wavelengths may be set in 1-nm increments within the range of the instrument (250-850 nm). A procedure to optimize excitation and emission wavelengths for a given assay is outlined in the next section.
- The 14 emission cutoff filters assist in reducing background. Sources of background include stray excitation light and native fluorescence of plate materials, sample constituents, and solvents (including water). The default setting allows the instrument and SOFTmax PRO software to determine which cutoff filter should be used (see Table 3.1 for default settings) in endpoint and kinetic modes. The spectral scan mode default uses no cutoff filter.
- The number of readings per well may vary between 1 (used for a quick estimate) and 30 (for very precise measurements). The default number of readings per well varies with the read mode: for fluorescence, the default is 6; for luminescence, the default is 30; for time-resolved fluorescence, the default is 20.
- The voltage of the photomultiplier tube may be set to low (for higher concentration samples), medium, or high (for lower concentration samples) in all read modes. In endpoint and spectrum mode, there is an additional setting, automatic, in which the instrument will automatically adjust the PMT voltage for varying concentrations of sample in the plate.
- The chamber of the SPECTRAmax GEMINI XS is isothermal at ambient as well as at elevated temperatures. The temperature in the reading chamber may be adjusted from 4°C above ambient to 45°C.
- In time-resolved fluorescence mode, you may set the integration start and end time in 200- μ second increments (minimum 50 μ sec/maximum 1450 μ sec).

Other important factors that are independent of the instrument but which affect assay optimization include the Stokes shift. When the Stokes' shift is very small, optimizing the excitation and emission wavelengths and correct cutoff filter choices are very important.



Using Spectral Scanning to Optimize Excitation and Emission Wavelengths for Fluorescence Assays

- 1) Put 200 μL of sample that includes the fluorophore and 200 μL of a buffer control into separate wells of a microplate.
- 2) Excitation Scan
 - A) Using SOFTmax PRO, set up a plate section for a fluorescence read, spectrum mode, Em Fixed/Ex Scan, with no cutoff filter (default), and medium PMT.
 - B) Set the emission wavelength based on the tentative value from the literature (or from a customary filter set used to measure your fluorophore). If the emission wavelength is not known, select a tentative emission wavelength about 50 nanometers greater than the absorbance maximum of the fluorophore. If necessary, the absorbance maximum can be determined by performing a spectral scan in a UV/Vis spectrophotometer.
 - C) Set the excitation scan to start/stop approximately 50 nm below/above the tentative excitation value obtained from the literature (or the customary excitation filter).
 - D) Set the step increment to 1 or 2 nm. (You may choose to do a preliminary scan with a 10-nm increment to determine the approximate peak location, and then repeat the scan over a narrower wavelength range with a 1 or 2 nm increment.)
 - E) Perform the scan and view the results as a plot of emission fluorescence vs. excitation wavelength. Note the excitation wavelength at the emission peak and the maximum RFU value.

NOTE: If an error message reporting missing datapoints occurs, it may be due to possible saturation reported by SOFTmax PRO at the end of the spectral scan. Reset the PMT to “low” and rescan the sample (scan the buffer blank with the PMT set to “medium” or “high”). If the error occurs after scanning with the PMT set to “low,” it may be necessary to dilute the sample.

NOTE: If the excitation scan shows no apparent peak, change the PMT setting to “high” and rescan the sample. If the spectral scan still shows no apparent peak, adjust the Y-scale of the zoom plot so that the plot fills the graph.

- F) Select the optimal excitation wavelength. If the excitation peak wavelength and emission wavelength are separated by more than 80 nm, use the excitation peak wavelength value. If the excitation and emission wavelengths are less than 80 nm apart, use the shortest excitation wavelength that gives 90% maximal emission. (Follow the plot to the left of the peak until the RFU value falls to approximately 90% of the maximum and then drop a line from the 90% point on the plot to the x-axis—see Figure 3.1.)

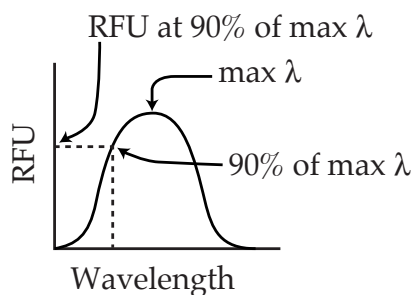

Figure 3.1: Plot of RFU vs. Wavelength

- 3) Emission Scan #1
 - A) In SOFTmax PRO, set up a second plate section for a fluorescence read, spectrum mode, Ex Fixed/Em Scan, with no cutoff filter (default), and medium PMT.
 - B) Set the excitation wavelength to the value determined in 2F above.
 - C) Set the emission scan to start/stop approximately 50 nm below/above the tentative emission value obtained from the literature (or existing filter pair).
 - D) Set the step increment to 1-2 nm (or do a preliminary scan with a 10-nm increment to determine the approximate peak location and then repeat the scan over a narrower wavelength range using a 1-2 nm increment.)
 - E) Perform the scan and view the results as a plot of fluorescence vs. emission wavelength.
- 4) Select an emission cutoff filter that will block as much of the residual excitation light as possible without unduly reducing the fluorescence signal. The cutoff wavelength choices are 420, 435, 475, 495, 515, 530, 550, 570, 590, 610, 630, 665, or 695 nm. The cutoff value should be near the maximum emission wavelength (preferably between the excitation wavelength and the maximal emission wavelength) but at least 35 nm greater than the excitation wavelength.
- 5) Emission Scan #2
 - A) In SOFTmax PRO, set up a third plate section for an emission scan as specified in Step 3 above, except selecting Manual Cutoff Filter and setting the wavelength to that determined in Step 4.
 - B) Perform the scan and view the results as a plot of fluorescence vs. emission wavelength. Note the wavelength giving the maximum emission (the optimal emission wavelength).
 - C) Compare the spectra of the sample containing the fluorophore to the spectra of the buffer blank to get an estimate of the signal-to-noise ratio. If there is significant background interference, repeat steps 5A and 5B with another choice of cutoff filter.



- 6) Results: The optimal excitation and emission wavelengths are those determined in steps 2F and 5B above.
- 7) Comments
 - A) In endpoint or kinetic fluorescence modes, the “Autofilter” feature will generally select the same cutoff filter wavelength as will the above optimization method. If desired, however, you may specify the cutoff filters manually.
 - B) For emission wavelengths less than 420 nanometers, experimental iteration is usually the best method of determining the optimal emission and excitation wavelengths. Begin optimization by performing steps 1–4 above. Try emission and excitation wavelength combinations with the 420 cutoff or with no cutoff filter. Similarly, for excitation wavelengths greater than 660 nanometers, try emission and excitation wavelength combinations with the 695 cutoff or with no cutoff filter.

Figure 3.2 shows the effects of different cutoff filters on a scan of fluorescein where excitation was fixed at 485 nm and emission was scanned from 490 nm to 560 nm (buffer blanks are not shown in this plot). Table 3.1 following lists default settings for the emission cutoff filters.

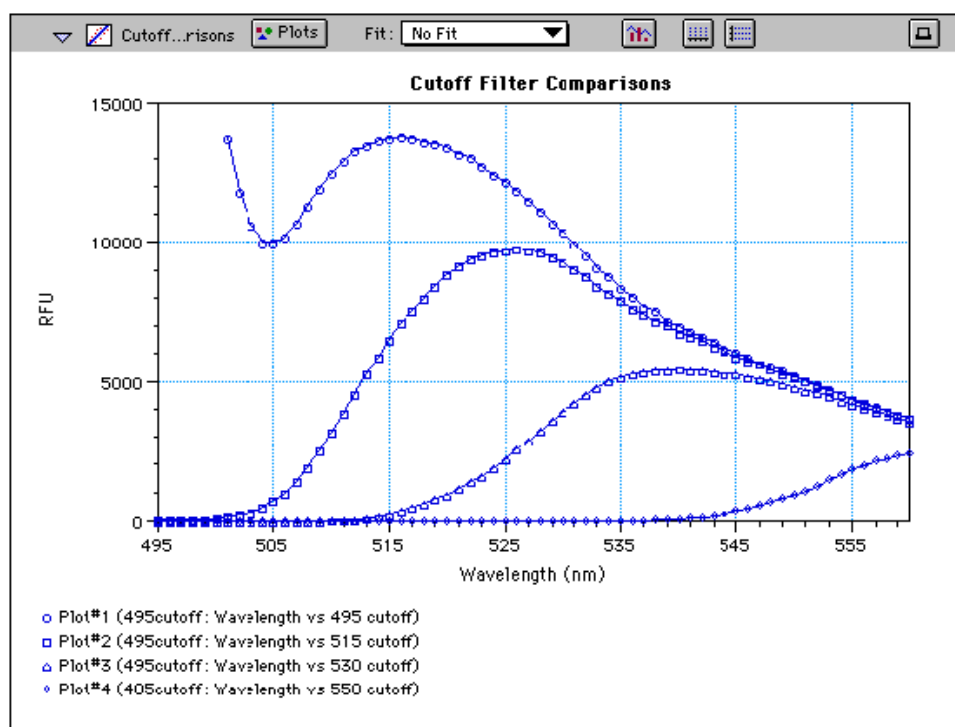

Figure 3.2: Effects of Cutoff Filters on Fluorescein. Emission was scanned from 490 to 560 nm; excitation was fixed at 485 nm.

*Table 3.1: Emission Cutoff Filter Default Settings*

Automatic Cutoff Selection		Endpoint and Kinetic Modes
#	λ (nm)	Emission λ (nm)
1	None	<415
2	420	415 - 434
3	435	435 - 454
4	455	455 - 474
5	475	475 - 494
6	495	495 - 514
7	515	515 - 529
8	530	530 - 549
9	550	550 - 569
10	570	570 - 589
11	590	590 - 609
12	610	610 - 629
13	630	630 - 664
14	665	665 - 694
15	695	695 - 850

Note: For spectrum mode, the default is “manual” (no automatic cutoff).



Chapter 4: Maintenance

Technical Support	4-3
Cleaning.	4-3
Cleaning the Fan Filter	4-4
Changing the Fuses	4-4
Installing the Drawer Adapter	4-6
Removing the Drawer Adapter.....	4-7
Moving the SPECTRAmax GEMINI XS.	4-7
Long-Term Shutdown	4-7







Technical Support

Molecular Devices Corporation is a leading worldwide manufacturer and distributor of analytical instrumentation. We are committed to the quality of our products and to fully supporting our customers with the highest possible level of technical service. In order to fully benefit from our technical services, please complete the registration card and return it to the address printed on the card.

If you have any problems using the SPECTRAmax GEMINI XS Dual-Scanning Microplate Spectrophotometer, in the U.S., contact our Technical Services group at 1-800-635-5577; elsewhere contact your local representative.

-  **WARNING:** All maintenance procedures described in this manual can be safely performed by qualified personnel. Maintenance not covered in this manual should be performed only by a Molecular Devices representative.
-  **WARNING:** Turn the power switch off and disconnect the power cord from the main power source before performing any maintenance procedure that requires removal of any panel, cover, or disassembly of any interior instrument component.
-  **WARNING:** Removal of protective covers that are marked with the High Voltage warning symbol shown below can result in a safety hazard.



Cleaning

-  **BIOHAZARD:** Wear gloves during any cleaning procedure that could involve contact with either hazardous or biohazardous materials or fluids.

Periodically, you should clean the *outside* surfaces of the SPECTRAmax GEMINI XS using a cloth or sponge that has been dampened with water. Do not use abrasive cleaners. If required, clean the surfaces using a mild soap solution diluted with water or a glass cleaner and then wipe with a damp cloth or sponge to remove any residue. Do not spray cleaner directly onto the instrument.

If needed, clean the microplate drawer using a cloth or sponge that has been dampened with water.

Should fluids spill in the drawer area (when the drawer is out), they will be directed to a tray at the bottom of the instrument, from which they will exit to the bench or counter beneath the instrument. Wipe up any spills immediately. Clean only the exterior of the unit (and the microplate drawer if necessary). **Never clean the inside of the instrument.** Do not allow excess water or other fluids to drip inside the instrument.



Cleaning the Fan Filter

The fan filter on the bottom of the instrument requires periodic cleaning. The frequency of the cleaning depends on how dusty your particular lab is and could range from once a month to once every six months.

- 1) Turn power to the instrument OFF and then remove the power cord and cables from the back of the instrument.
- 2) Remove any plate or adapter from the instrument drawer. Turn the instrument over so that it rests flat on the bench.
- 3) Pop the black fan cover off and remove the filter.
- 4) Clean the filter by blowing clean, canned air through it or by rinsing it—first with water and then with alcohol—and allowing it to dry completely.
- 5) Place the clean, dry filter over the fan and replace the black cover.
- 6) Turn the instrument back over. Reconnect the power cord and cables to the instrument.

Changing the Fuses

Fuses burn out occasionally and must be replaced. If the instrument does not seem to be getting power after switching it on (the LCD shows no display), first check to see whether the power cord is securely plugged in to a functioning power outlet and to the receptacle at the rear of the SPECTRAmax GEMINI XS. If power failed while the SPECTRAmax GEMINI XS was already on, check that the power cord is not loose or disconnected and that power to the power outlet is functioning properly. If these checks fail to remedy the loss of power, follow the steps listed below to replace the fuses. Spare fuses (two U.S. and two metric) are shipped with the instrument. The U.S. and metric fuses are identical except for physical size. They may be taped to the back of the SPECTRAmax GEMINI XS.

If you no longer have spare fuses, you may obtain new ones from Molecular Devices (part numbers: 4601-0013 for U.S., 4601-0014 for metric) or from a local hardware store. Make sure fuses are rated SLOWBLOW (U.S.: 4-amp time-delay; metric: 4-amp, 5 × 20 mm, time-delay).

To change fuses, follow the steps below.

- 1) Switch power to the instrument off and then remove the power cord from the outlet and from the SPECTRAmax GEMINI XS power cord receptacle.
- 2) Remove the printer cable and computer cable (if connected) from the back of the SPECTRAmax GEMINI XS.
- 3) Turn the instrument around for easy access to the rear panel.
- 4) On the left-hand side of the rear panel (viewed from the back) is the power switch, fuse box, and power cord receptacle. As shown in the figures below, press to the right of the black plastic cover of the fuse box to release it. Pull the fuse box cover away from the instrument. The fuse box will begin to slide forward.

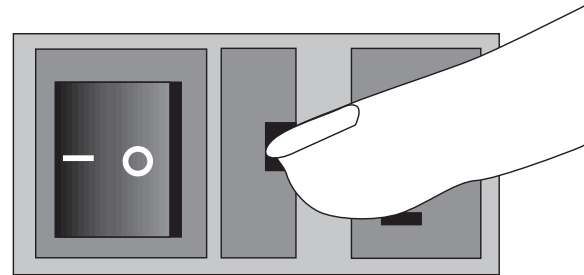
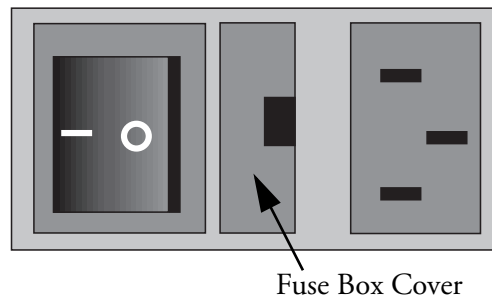

Figure 4.1: Power Switch, Fuse Box, and Power Receptacle

- 5) Continue gently pulling the fuse box forward until it is free of the instrument.

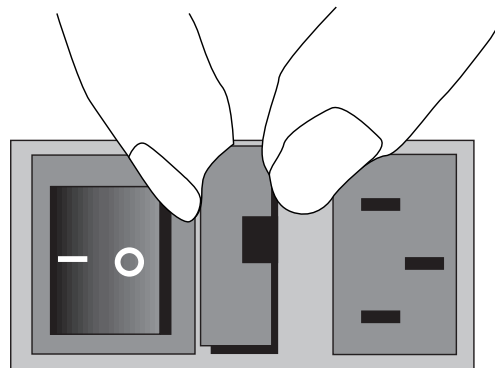

Figure 4.2: Removing the Fuse Box

- 6) When removed, the fuse assembly will appear as shown in Figure 4.3. The holder inside contains two fuses.
- 7) It is possible that only one of the fuses may have blown. Molecular Devices recommends that you replace both fuses, however, to ensure continued proper operation. Pull both fuses out of the holder and discard them.

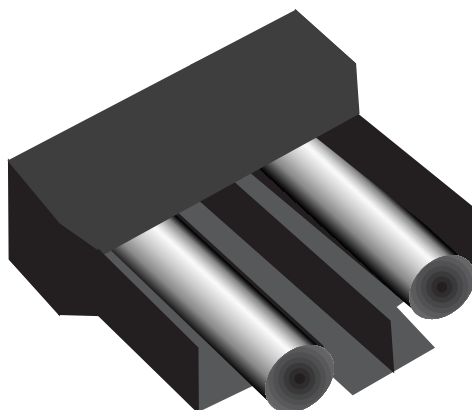

Figure 4.3: *The Fuse Box and Holder (with Fuses) Removed*

- 8) Insert new SLOWBLOW-rated fuses into the fuse holder. Either end of the fuse may be forward.
- 9) Insert the fuse box into the opening in the instrument, making sure that the fuses are on the right side (toward the power receptacle). Press the fuse box into place, making sure the cover snaps closed.
- 10) Reconnect the power cord to the instrument and to the wall outlet and reconnect other cables previously disconnected.

Installing the Drawer Adapter

If you are reading standard 96-well or 384-well microplates, you will need to install a drawer adapter. Two plate carrier adapters are provided with the instrument. The blue adapter is required for optimum performance with standard 96- and 384-well format microplates. The red adapter has been optimized for use with Cliniplate 384 microplates. Both adapters are included in the instrument accessory kit.

⚠ CAUTION: Incorrect insertion or removal of either adapter may cause damage to the microplate drawer of the SPECTRAmax GEMINI XS.

- 1) Turn power to the instrument on.
- 2) Press the Drawer open button on the front panel or the drawer open command in SOFTmax PRO software.
- 3) Hold the adapter so that the label is on the left side facing up.
- 4) Place the top back (Row A) portion of the adapter into the drawer first. While pushing against the back edge of the adapter, lower the front of the adapter into the drawer.



Removing the Drawer Adapter

If you are reading “high profile” (6-, 12-, 24-, or 48-well) plates and the adapter is in the drawer, you will need to remove it.

⚠ CAUTION: Incorrect insertion or removal of an adapter may cause damage to the microplate drawer of the SPECTRAmax GEMINI XS.

- 1) Turn power to the instrument on.
- 2) Press the **Drawer** button on the front panel or activate the drawer open command in SOFTmax PRO software.
- 3) Hold the adapter at the front (long side of the drawer) and push toward the back (Row A).
- 4) Lift the front (Row H) of the adapter and remove it from the drawer.

Moving the SPECTRAmax GEMINI XS

If you need to relocate the SPECTRAmax GEMINI XS, follow these steps.

⚠ WARNING: The SPECTRAmax GEMINI XS weighs approximately 35 pounds (16 kilograms). To avoid injury, it is recommended that two people lift the instrument together, using proper lifting techniques.

- 1) Remove any microplate (*and the adapter, if any*) from the drawer and then close the drawer.

⚠ CAUTION: Leaving the adapter in the drawer when moving the SPECTRAmax GEMINI XS could cause damage to the instrument.

- 2) Turn off the power switch and unplug the power cord from the source and from the receptacle on the back of the instrument.
- 3) Depending on the distance that you will be moving the instrument, you may wish to repackage the SPECTRAmax GEMINI XS in its original shipping carton. Otherwise, carry the instrument or place it on a rolling cart to transport it.
- 4) Ensure that the new location meets the proper specifications as described in Chapter 2, “Installation.”

Long-Term Shutdown

If you will not be using the SPECTRAmax GEMINI XS for an extended period of time, clean the *external* surfaces of the instrument.



Chapter 5: Troubleshooting

Error Codes and Resolutions	5-3
Opening the Drawer Manually	5-4







This chapter lists error codes that may occur while using the instrument, followed by their most likely causes and remedies. Maintenance procedures are described in Chapter 4. For problems with the SPECTRAmax GEMINI XS that are not listed here, in the U.S., contact Molecular Devices Technical Services group at 1-800-635-5577; elsewhere, call your local representative.

BIOHAZARD: It is your responsibility to decontaminate the instrument, as well as any accessories, before requesting service by Molecular Devices representatives and before returning the instrument or any components to Molecular Devices Corporation.

Error Codes and Resolutions

If a problem occurs during operation that causes an unrecoverable (fatal) error, the instrument will stop and an error code number will be shown in the display on the front panel. Some errors are caused by equipment malfunction and others result from incorrect input. Some error codes are listed in Table 5.1, along with their probable causes and remedies. If any of the following error codes appear on the LCD display, cycle the power to the instrument (turn power off and then on again after a few seconds). If the error message still appears and no specific note appears next to that error message, call Molecular Devices Technical Support: in the United States and Canada, call (800) 635-5577; elsewhere call your local Molecular Devices representative for assistance.

Table 5.1: Error Codes and Resolution

Error Code	Resolution
203	
217	
218	
220	
221	
222	
303	Make sure drawer is closed. Turn the instrument power switch off and then on again. If the error message still appears, call Technical Support.
304	



Table 5.1: Error Codes and Resolution

Error Code	Resolution
305	Make sure nothing is blocking the drawer. Open the drawer using the open drawer button, and make sure the microplate is firmly seated in the carriage. Turn the instrument power switch off and then on again. If the error message persists, call Technical Support.
306	
307	
318	
319	
320	
321	
323 Warning	Warning — Low lamp (light) level. Call Molecular Devices to arrange for lamp replacement as soon as possible.
323 Fatal	Fatal error — Low lamp level. Lamp does not provide enough light to continue operation. Contact Molecular Devices to arrange for lamp replacement.
324	PMT calibration coefficient check failure. Turn the instrument power off and then on again. If the problem persists, contact Molecular Devices.

For all other error messages (codes not listed here), please contact your local Molecular Devices representative for assistance.

Opening the Drawer Manually

If an error occurs while the drawer is closed and you need to remove a microplate, press the **[Drawer]** key. If the drawer does not open, turn power to the instrument off and then on again. If the drawer remains closed, turn the incubator off (if it was on) by pressing the **[Temp on/off]** key.

If the drawer still remains closed, try using a blunt, flat object (such as a spatula) to open the door. With your index finger, pull the microplate drawer out of the instrument (*do not force the drawer*) and remove the microplate. This action will not harm the instrument, but should only be taken if the first two options have failed to open the drawer.

If you are still unable to open the drawer, contact your local Molecular Devices representative.

Appendix A Cables and Accessories

Cables A-3
Items Available for Use with the
SPECTRAmax GEMINI XS A-3

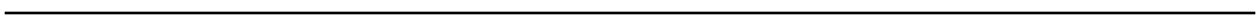





Cables

Molecular Devices recommends that you use high-quality, double-shielded cables to connect the SPECTRAmax GEMINI XS to the computer. Choose cables that meet the following requirements:

Serial Interface Cable

(contact Molecular Devices for specific pin-out requirements)

Macintosh: Male DB8 to male DB8

IBM Compatible: Male DB8 to Female DB9

Items Available for Use with the SPECTRAmax GEMINI XS

Cable, RS-232 (instrument to Macintosh computer)	9000-0091
Cable, RS-232 (instrument to PC computer).	9000-0149
Power Cord	4400-0002
Fuse, 4-amp Time Delay	4601-0013
Fuse, 4-amp (5 × 20 mm) Time Delay.	4601-0014
SPECTRAmax Mouse Pad.	9000-0133



*Appendix B Common Wavelengths
for Fluorescence,
Time-Resolved
Fluorescence, and
Luminescence*

Fluorescence. B-3
Time-Resolved Fluorescence B-3
Luminescence. B-4





NOTE: Values in this table are based on the literature. You may wish to scan your fluorochrome of interest in the SPECTRAmax GEMINI XS to determine the optimal excitation and emission wavelengths for your application.

Fluorescence

Fluorophore	Excitation Wavelength	Emission Wavelength
HPPA	320	405
4-MeU, NADH, NADPH	355	460
Biotinidase	355	544
PKU	390	485
Green Fluorescent Protein	390	510
Attosph/ Attofluor	444	555
FITC	485	538
Ethidium Homodmer (DNA)	530	620
TRITC, Ethidium Bromide	544	590
Texas Red	584	612
TAMRA	547	580
Tryptophan	280	340
La Jolla Blue	695	705

Time-Resolved Fluorescence

Fluorophore	Excitation Wavelength	Emission Wavelength
Eu-Chelate	360	610



Luminescence

Probe	Wavelength
Emerald and Emerald II ^a	542
Sapphire and Sapphire II ^a	461
Ruby ^a	620

^a Emerald, Emerald II, Sapphire, Sapphire II, and Ruby are trademarks of Tropix, Inc.



Index

A

Adapter 1-3, 1-6, 2-4, 4-6
Automix 1-15, 1-18
 endpoint 1-15
 kinetic 1-15

B

Background interference 1-11
Bandwidth 1-16

C

Cables
 computer 1-8
Cleaning 4-3
Computer control 1-15
Connections 1-4, 1-8
 printer 1-8
Control panel 1-4, 1-5
Cutoff filter 1-10

D

Drawer
 adapter 1-3, 1-6, 2-4, 4-6
 incubator status 1-6
 key 1-5
 open 1-5
 open manually 5-4
Dye
 lanthanide 1-10, 1-12

E

Emission scan (spectral) 1-18
Emission wavelength 1-16
Endpoint 1-13
Errors 5-3
Excitation scan (spectral) 1-18
Excitation wavelength 1-16

F

Fan filter 4-4
Filter
 cutoff 1-10
 long-pass 1-7, 1-10
Flashlamp 1-7
Fluorescence
 time-resolved 1-12
Fluorophore 1-18
Fuses 4-4
 accessing 1-8

G

Glossary of Terms 1-18

I

Incubator 1-5, 1-6, 1-14, 3-3
Installation 2-3
Interference 1-11

K

Key
 Drawer 3-5
Keys (control panel) 1-5
Kinetic 1-13
Kinetic read
 add reagents 1-5

L

Labels 1-9
Lanthanide 1-10, 1-12
LCD (Liquid Crystal Display) 1-5, 1-19, 3-7
Long-pass filter 1-7
Luminescence 1-12, 1-19



M

- Microplate 1-3
 - 96-well 1-6
 - adapter 1-3, 1-6, 2-4, 4-6
- Microplate drawer 1-4, 1-5, 1-6
 - closing 1-6
 - incubator status 1-6
- Mode
 - endpoint 1-13
 - kinetic 1-13
 - spectrum 1-13
 - well scanning 1-13
- Monochromator (scanning) 1-3, 1-7

O

- Operation
 - Theory 1-10
- Optical system 1-7
- Optics system 1-4
- Optimizing assays 1-11, 3-9

P

- PMT 1-8
- Power cord 1-8
- Power switch 1-4, 1-8, 3-3
- Printer port 1-8

R

- Read mode 3-4
- Reagents, adding during a kinetic read 1-5
- Remote control 1-15

S

- Serial port 1-8
- Set point 1-5
- Shutdown, long-term 4-7
- SOFTmax PRO 1-3, 1-13, 1-15
- Spectral emission scan 1-18
- Spectral excitation scan 1-18
- Spectrophotometer
 - moving the instrument 4-7
- Spectrum 1-13
- Spills 4-3
 - cleaning 4-3
- Stand-alone operation 2-4
- Stokes shift 1-10, 1-20

T

- Technical service 4-3
- Temperature 3-6
 - equilibration 3-3
 - incubator 3-3
 - limits 3-3
 - regulation 1-14
 - set point 1-5, 3-3
 - setting 3-3
 - stabilization 1-14
- Temperature (incubator) 1-5
- Theory of Operation 1-10
- Time-resolved fluorescence 1-12, 1-20

W

- Warranty ii
- Wavelength 3-8
 - emission 1-10, 1-11
 - excitation 1-10, 1-11
 - range 1-16
 - Selection 3-9
- Well scanning 1-13