



**Thermo Scientific**

# **Sorvall RC6 Plus**

Superspeed Centrifuge

## **Instruction Manual**

501057486-6

January 2012

Visit us online to register your warranty.  
[www.thermoscientific.com/labwarranty](http://www.thermoscientific.com/labwarranty)



**Thermo Scientific**

# **Sorvall RC6 Plus**

**Instruction Manual**

50105748-6

January 2012

© 2012 Thermo Fisher Scientific Inc. All rights reserved.

Delrin, TEFLON, and Viton are registered trademarks of DuPont. Noryl is a registered trademark of SABIC. POLYCLEAR is a registered trademark of Hongye Chemical Co., Ltd. Hypaque is a registered trademark of Amersham Health As. RULON A and Tygon are registered trademarks of Saint-Gobain Performance Plastics. Alconox is a registered trademark of Alconox. Ficoll is a registered trademark of GE Healthcare. Haemo-Sol is a registered trademark of Haemo-Sol. Triton X-100 is a registered trademark of Sigma-Aldrich Co. LLC.

All other trademarks are the property of Thermo Fisher Scientific Inc. and its subsidiaries.

Thermo Electron LED GmbH  
Robert-Bosch-Straße 1  
D - 63505 Langenselbold  
Germany

Thermo Fisher Scientific Inc. provides this document to its customers with a product purchase to use in the product operation. This document is copyright protected and any reproduction of the whole or any part of this document is strictly prohibited, except with the written authorization of Thermo Fisher Scientific Inc.

The contents of this document are subject to change without notice. All technical information in this document is for reference purposes only. System configurations and specifications in this document supersede all previous information received by the purchaser.

**Thermo Fisher Scientific Inc. makes no representations that this document is complete, accurate or error-free and assumes no responsibility and will not be liable for any errors, omissions, damage or loss that might result from any use of this document, even if the information in the document is followed properly.**

This document is not part of any sales contract between Thermo Fisher Scientific Inc. and a purchaser. This document shall in no way govern or modify any Terms and Conditions of Sale, which Terms and Conditions of Sale shall govern all conflicting information between the two documents.

Release history: 50105748-6 printed in January 2012.

**For Research Use Only. Not for use in diagnostic procedures.**

## WEEE Conformity

This product is subject to the regulations of the EU Waste Electrical & Electronic Equipment (WEEE) Directive 2002/96 It is marked by the following symbol:



Thermo Fisher Scientific has entered into agreements with recycling and disposal companies in all EU Member States for the recycling and disposal of this device. For information on recycling and disposal companies in Germany and on the products of Thermo Fisher Scientific, which fall under the RoHS Directive (Restriction of the use of certain hazardous substances in electrical and electronic equipment), please visit the website [www.thermo.com/WEEERoHS](http://www.thermo.com/WEEERoHS)



## KONFORMITÄTSERKLÄRUNG DECLARATION OF CONFORMITY

Name und Anschrift des Herstellers und des Bevollmächtigten  
für die Zusammenstellung der relevanten technischen Unterlagen:  
Name and address of the manufacturer and of the authorized  
representative to compile the relevant technical documentation:

**Thermo Electron LED GmbH**  
**Werk Osterode**  
**Am Kalkberg**  
**D-37520 Osterode am Harz**

*Hiermit erklären wir, dass die nachstehend beschriebene Maschine  
Herewith we declare, that the machinery described below*

<b>Beschreibung /description</b>	<b>: Labor-Zentrifuge</b>
<b>Modellbezeichnung / model name</b>	<b>: Sorvall RC-6 Plus</b>
<b>Modellnr/ model no.</b>	<b>: 46910</b>
<b>Gültig ab Equipmentnr. Valid from equipment no.</b>	<b>: A4171</b>

*mit allen einschlägigen Bestimmungen der Maschinenrichtlinie 2006/42/EG in Übereinstimmung ist.  
is in conformity with all relevant terms of directive for machinery 2006/42/EC.*

*Die Maschine ist auch in Übereinstimmung mit allen einschlägigen Bestimmungen der Richtlinie  
2004/108/EG über elektromagnetische Verträglichkeit.  
The machinery is in accordance with all relevant terms of directives for electromagnetic compatibility  
2004/108/EC.*

*Die Schutzziele der Niederspannungsrichtlinie 2006/95/EG werden eingehalten.  
The protection goals of the directive for low voltage 2006/95/EC are met.*

Angewandte harmonisierte Normen/  
Harmonized standards used:

**EN 61010-1: 2004**  
**EN 61010-2-020: 2006**  
**EN 61326-1: 2006**  
**EN 55011B: 2007**

Osterode, den 16.01.2012

Dr. Andreas Karl  
Director R&D

Ort, Datum, Name, Funktion und Unterschrift /  
Place, date, name, function and signature

	Name	Datum	Dokument	Revision
Erstellt	Lienemann	17.08.2012	46910	00
Freigegeben	Laaboubi	17.08.2011		

# Table of Contents

	<b>Thermo Scientific Sorvall RC6 Plus™ Superspeed Centrifuge</b> .....	<b>iii</b>
	<b>Important Safety Information</b> .....	<b>iv</b>
	Mechanical Safety .....	iv
	Safety During Installation and/or Maintenance .....	v
	Electrical Safety .....	vi
	Safety Against Risk of Fire .....	vi
	Chemical and Biological Safety .....	vi
<b>Chapter 1</b>	<b>INTRODUCTION &amp; DESCRIPTION</b> .....	<b>1-1</b>
	Centrifuge Description .....	1-2
	Centrifuge Specifications .....	1-4
	Centrifuge Accessories .....	1-5
<b>Chapter 2</b>	<b>INSTALLATION</b> .....	<b>2-1</b>
	Inspection .....	2-2
	Identify the Installation Site .....	2-2
	Leveling the Centrifuge .....	2-3
	Electrical Requirements .....	2-4
	Relocation .....	2-5
<b>Chapter 3</b>	<b>CONTROLS, DISPLAYS &amp; INDICATORS</b> .....	<b>3-1</b>
	Controls, Displays, & Indicators .....	3-2
	Operation Panel .....	3-2
	POWER Switch .....	3-5
	Diagnostic Indicators Safety Device .....	3-6
<b>Chapter 4</b>	<b>OPERATION</b> .....	<b>4-1</b>
	Reducing Speed for Loads in Excess of Design Mass .....	4-2
	Basic Operation .....	4-2
	Normal Operating Procedure .....	4-7
	Saving and Changing Run Conditions .....	4-10
	Step-mode Operation .....	4-13
	RTC (Real Time Control) Operation .....	4-14
	Displaying and Setting RCF .....	4-17
	Displaying and Setting w2T .....	4-19
	Emergency Recovery from Power Failure .....	4-20
	Features on Menu Screen .....	4-22
	Lockout system function (optional) .....	4-24
<b>Chapter 5</b>	<b>CARE AND MAINTENANCE</b> .....	<b>5-1</b>
	Rotor Chamber .....	5-3
	Tapered Drive Shaft (Drive Spindle) .....	5-3
	Cabinet .....	5-4

	Rotor .....	5-4
	Condenser Fins .....	5-4
	Replacement Parts .....	5-4
	Service Decontamination Policy .....	5-4
<b>Chapter 6</b>	<b>TROUBLESHOOTING .....</b>	<b>6-1</b>
	Alarm Messages .....	6-2
	<b>Rotor Information Table .....</b>	<b>A-1</b>
	<b>Chemical Compatibility Chart .....</b>	<b>B-1</b>
	<b>Warranty .....</b>	<b>C-1</b>
	<b>Contact Information .....</b>	<b>D-1</b>



This manual is a guide for the use of

# Thermo Scientific Sorvall RC6 Plus™ Superspeed Centrifuge

Data herein has been verified and is believed adequate for the intended use of the rotor.

Because failure to follow the recommendations set forth in this manual could produce personal injury or property damage, always follow the recommendations set forth herein. Thermo Fisher Scientific does not guarantee results and assumes no obligation for the performance of rotors or other products that are not used in accordance with the instructions provided. This publication is not a license to operate under, nor a recommendation to infringe upon, any process patents.

Publications prior to the Issue Date of this manual may contain data in apparent conflict with that provided herein. Please consider all data in this manual to be the most current.

DANGER, WARNING, CAUTION, and NOTE within the text of this manual are used to emphasize important and critical instructions.

DANGER informs the operator of an extreme hazard or an unsafe practice that will result in death or serious injury.

WARNING informs the operator of a hazard or an unsafe practice that could result in serious injury, affect the operator's health, or contaminate the environment.

CAUTION informs the operator of an unsafe practice that could result in damage to equipment.

NOTE highlights essential information.



DANGER, CAUTION, and WARNING are accompanied by this symbol.

# Important Safety Information

Certain potentially dangerous conditions are inherent to the use of all centrifuges. To ensure safe operation of this centrifuge, anyone using it should be aware of all safe practices and take all precautions described below and throughout these operating instructions.

## Mechanical Safety



### WARNING

For operator safety, maintain a 30-cm "clearance envelope" around the instrument while the rotor is spinning. Do not store dangerous substances capable of developing flammable or explosive vapors in the clearance envelope.

Do not attempt to unlock the door forcefully while the rotor is spinning.

Do not attempt to slow or stop the spinning rotor by hand.

Do not incline or move the instrument while the rotor is spinning. Do not lean on the instrument.

If abnormal sound or vibration occurs, stop the operation immediately and contact Thermo or your local representative of Thermo Fisher Scientific products.



### CAUTION

Before using a rotor, be sure to read through the rotor instruction manual.

Maximum rotor speed depends on the rotor, buckets, assemblies, tubes or adapters to be used. Follow the instructions in the rotor instruction manual.

Do not use corroded, scratched or cracked rotors, buckets and assemblies. Check that the rotor, buckets and assemblies are free of such abnormalities before operation.

When using a swinging bucket, check that the buckets are properly engaged with the rotor pins before operation. An incorrect setting can cause severe damage to the instrument.

Be sure to mount the rotor cover if provided. Check that the rotor cover is completely secured with a screw if provided.

Mount the rotor onto the drive shaft (drive spindle) gently and properly. Do not drop the rotor or apply excessive force to the drive shaft (drive spindle).

Clean the inside of the drive hole (drive spindle hole) of the rotor and the surface of the drive (drive spindle) of the centrifuge once a week.

If condensation is in the rotor chamber, wipe the chamber dry with a dry sponge or cloth.

**CAUTION**



Do not pour any solution such as water, detergent or disinfectant directly into the rotor chamber. Otherwise, the bearings of the drive unit may corrode or deteriorate.

Before relocating the centrifuge, remove the rotor from the rotor chamber to avoid damage to the drive shaft.

Always keep the liquid crystal panel in a visible position while the POWER switch is turned on, so that you can check the current operating state (running or stopping).

## Safety During Installation and/or Maintenance



**DANGER**

When servicing the centrifuge, be sure to turn off the POWER switch, turn off the distribution board of your centrifuge room, and then wait for at least three minutes before removing covers or tables from the centrifuge to avoid electrical shock hazards.

**WARNING**

Level the centrifuge by using the four level adjusters and secure them completely. Improper securing can cause significant movement of the centrifuge in the event of a rotor disengagement.



Installation or relocation of your centrifuge must be done by Thermo Fisher Scientific or a Thermo Fisher Scientific representative. Contact Thermo Fisher Scientific or your local representative of Thermo Fisher Scientific products.

Do not position an object so that it is difficult to disconnect the power cord from the outlet. If you do so, you cannot disconnect the power cord from the outlet when you observe some abnormality.

**CAUTION**



Avoid places that are exposed to ultraviolet rays for operation or storage of the centrifuge. Otherwise, the covers can be discolored and the coating can be peeled off easily. If installation in such a place is unavoidable, cover the centrifuge with a cloth after operation to protect from ultraviolet rays.

If you encounter any problem concerning maintenance that is not covered in the operation manual, please contact Thermo Fisher Scientific for assistance. For addresses, refer to the rating label on the right side of the centrifuge.

## Electrical Safety



### WARNING

Your centrifuge must be grounded properly to avoid electrical shock hazards.



### CAUTION

Do not place containers holding liquid on or near the instrument or in the rotor chamber. If they spill, liquid may get into the instrument and damage electrical components.

## Safety Against Risk of Fire



### WARNING

This instrument is not designed for use with materials capable of developing flammable or explosive vapors or extreme exothermic reactions. Do not centrifuge such materials in this instrument nor handle or store them near the instrument.

## Chemical and Biological Safety



### WARNING

When using radioactive, toxic, or pathogenic materials, be aware of all characteristics of the materials and the hazards associated with them in the event leakage occurs during centrifugation. If leakage does occur, neither the centrifuge nor the rotor can protect you from particles dispersed in the air. To protect yourself, we recommend additional precautions be taken to prevent exposure to these materials, for example, use of controlled ventilation or isolation areas.

Always be aware of the possibility of contamination when using radioactive, toxic, or pathogenic materials. Take all necessary precautions and use appropriate decontamination procedures if exposure occurs.

The use of sealed rotors, buckets and/or sample containers will provide increased protection from contamination during routine operation. However, these items will not guarantee contamination protection from accidents resulting in damage to the rotor or buckets. Do not run hazardous materials in the centrifuge unless placed in a biohazard enclosure and operated using all appropriate safety precautions.

## Notice for an Earthquake

An abnormality may be found on the centrifuge depending on the magnitude of an earthquake.

If any abnormality is found, stop using the centrifuge immediately and ask for inspection by Thermo or your local representative of Thermo Fisher Scientific products.

# INTRODUCTION & DESCRIPTION

This manual provides you with the information you will need to operate and maintain your Thermo Scientific Sorvall RC6 Plus<sup>TM</sup> Superspeed Centrifuge. If you encounter any problem concerning either operation or maintenance that is not covered in the manual, please contact Thermo Fisher Scientific for assistance. In the United States, call toll-free 1-866-9THERMO; outside the United States, contact your local distributor or agent for Thermo Fisher Scientific products. Thermo Fisher Scientific product information is available on our internet web site at <http://www.thermo.com>

## Contents

- “Centrifuge Description” on page 1-2
- “Centrifuge Specifications” on page 1-4
- “Centrifuge Accessories” on page 1-5

## Centrifuge Description

The RC6 Plus is a high-speed (to 22,000 rpm) centrifuge used to separate substances of different densities at controlled temperatures. Some of the outstanding features of the RC6 Plus are:

- Speeds to 22,000 rpm (55,200 x g) without the need for a vacuum system
- Process 4 liters of sample in a single run
- High-frequency brushless motor for fast separations and reduced maintenance
- RCF control allows set and display of g-force
- $\omega^2 dt$  integrator for run-to-run reproducibility
- Real Time Control for delayed start/stop runs
- 30 program memory
- 9 acceleration and 10 deceleration settings
- On-line rotor catalog
- Pre-cool function for fast rotor pre-cooling
- Wide choice of rotors including Fiberlite carbon fiber rotors.

The RC6 Plus centrifuge is capable of operation in more than one mode to meet a wide range of applications. Run conditions are selected using the touch keyboard. Actual and set run conditions are displayed. For your protection, system interlocks keep the centrifuge from starting if the chamber door is open, and prevent the door from being opened if a run is in progress and the rotor is spinning. System interlocks will also automatically terminate a run in progress if a system malfunctions.

The RC6 Plus drive system has a high-frequency brushless motor for fast separations and reduced maintenance.

The refrigeration system, charged with environmentally- friendly CFC-free SUVA<sup>®</sup> refrigerant, offers reliable performance similar to other Thermo Scientific Superspeed centrifuges. The high-capacity refrigeration system is a low temperature, hermetically-sealed unit that consists of a compressor, a condenser, an evaporator/rotor chamber, and interconnecting tubing. When the centrifuge is running, the refrigeration system will maintain selected temperatures within the range specified for the centrifuge.

The RC6 Plus accepts the Thermo Scientific Superspeed rotors listed in the Rotor Information Table in the Appendix.

Refer to Figure 1-1 to identify the parts of the RC6 Plus.

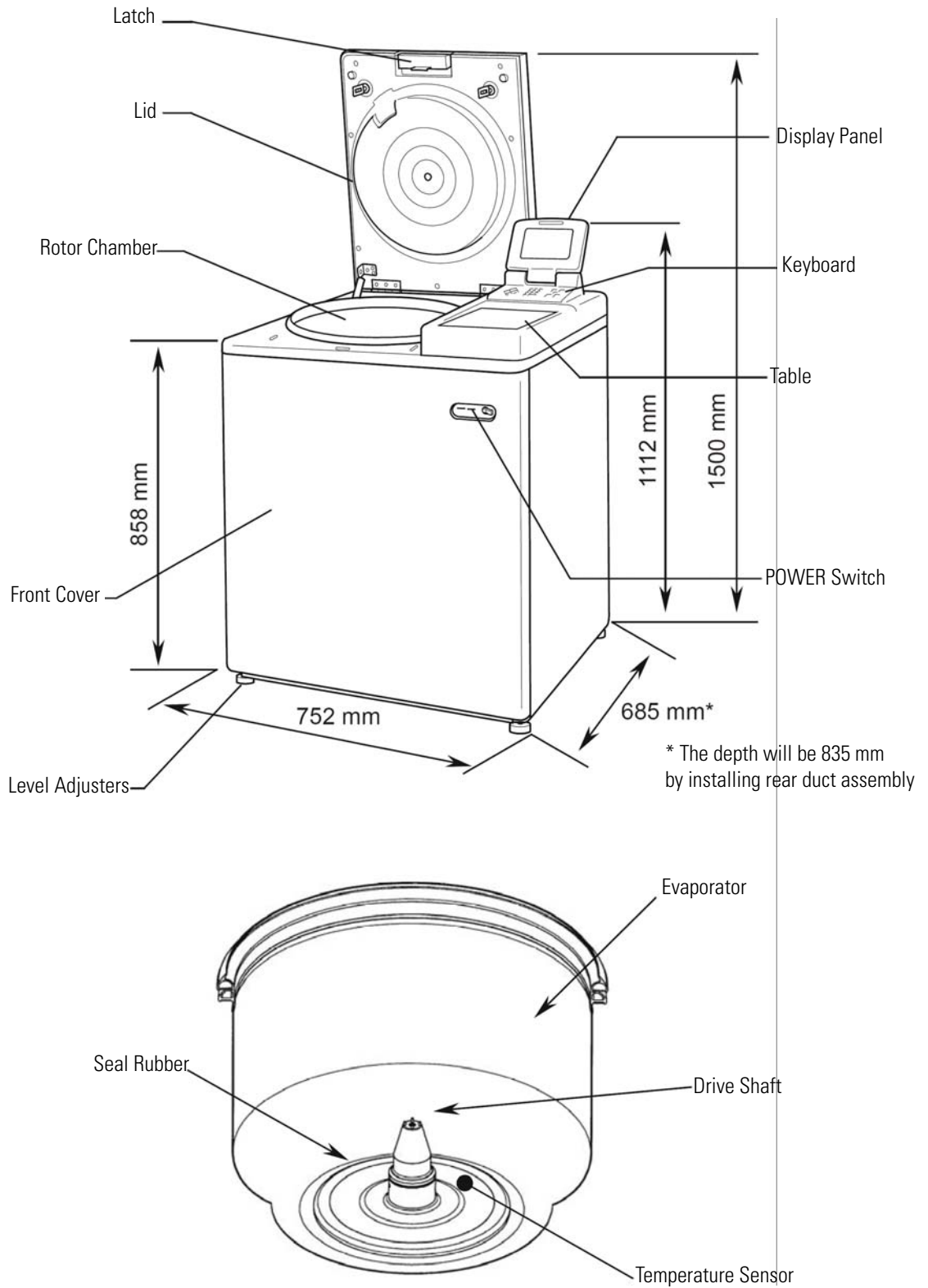

**Figure 1-1.** Centrifuge Parts Location and Identification

## Centrifuge Specifications

**Table 1-1.** Centrifuge Specifications

Run Speed*	
Speed Selection Range (rpm)	300 to 22,000
Speed Control Accuracy	±25 rpm
Maximum Relative Centrifugal Force	52,200 x g (F22/Micro)
Run Temperature	
Temperature Selection Range	-20°C to 40°C**
Temperature Control Range	2°C to 40°C
Temperature Control Accuracy	±2°C
Run Time Selection Range	
	1 minute to 99 hours, 59 minutes HOLD for continuous operation
Ambient Temperature Range	2°C to 40°C***
Mass (Weight)	350 kg
Maximum Capacity	4,000 ml (F10S-4x100 LEX)
Dimensions	
Width	752 mm
Height to top of control console	1112 mm
Height with door open	1500 mm
Depth (including rear duct assembly)	835 mm
Depth (without rear duct assembly)	685 mm
From bottom to chamber inlet	858 mm
Noise Level	<64 dB ****
Heat Output	3.7 kW (12,600 BTU/h) *****

\* Speed in revolutions per minute (rpm) is related to angular velocity,  $\omega$ , according to the following:

$$\omega = (\text{rpm}) \left( \frac{2\pi}{60} \right) = (\text{rpm})(0.10472)$$

Where  $\omega$  = rad/s. All further references in this manual to speed will be designated as rpm.

\*\* The centrifuge will operate at ambient temperatures up to 40°C, but refrigeration system performance may be less than optimal above 25°C.

After the centrifuge system has reached equilibrium. Ambient air temperature at the centrifuge air inlets must be between 2°C to 40°C with maximum relative humidity of 80% at 31°C, linearly decreasing to 50% at 40°C. If the ambient air temperature is above 25°C, the centrifuge may not maintain low temperatures at high speeds, therefore, avoid areas near heat sources (for example, direct sunlight, heating pipes and radiators). Also, avoid close grouping of centrifuges or other heat-producing laboratory equipment.

\*\*\* After the centrifuge system has reached equilibrium. Ambient air temperature at the centrifuge air inlets must be between 2°C to 40°C with maximum relative humidity of 80% at 31°C, linearly decreasing to 50% at 40°C. If the ambient air temperature is above 25°C, the centrifuge may not maintain low temperatures at high speeds, therefore, avoid areas near heat sources (for example, direct sunlight, heating pipes and radiators). Also, avoid close grouping of centrifuges or other heat-producing laboratory equipment.

\*\*\*\* As measured with SE-12 rotor at 22,000 rpm (with compressor turned on) 3 feet from the front of the unit and four feet from the floor.

\*\*\*\*\* For the SS-34 rotor spinning 20,000 rpm at 4°C, after it has reached equilibrium. Other rotors, speeds, and temperatures cause the heat output to vary.



## Centrifuge Accessories

The following items are provided with the centrifuge:

<b>Catalog No.</b>	<b>Description</b>
50105748	Instruction manual
50131068	CD with additional manuals
	Level
	Rear duct assembly (To be mounted to the rear cover at installation)

## **1 INTRODUCTION & DESCRIPTION**

Centrifuge Accessories

# INSTALLATION

Installation or relocation of your centrifuge must be done by an authorized Thermo Fisher Scientific representative. Contact Thermo Fisher Scientific or your local representative of Thermo Fisher Scientific products.

After you receive your centrifuge, inspect it for damage before using it. The RC6 Plus centrifuge must be installed in a location that meets all of the electrical, location, and environment requirements that are specified below and on the following pages.

## Contents

- “Inspection” on page 2-2
- “Identify the Installation Site” on page 2-2
- “Leveling the Centrifuge” on page 2-3
- “Electrical Requirements” on page 2-4
- “Relocation” on page 2-5

## Inspection

As soon as you receive your RC6 Plus Superspeed Centrifuge carefully inspect it for any shipping damage that may have occurred. If you find any damage, please report it immediately to the transportation company and file a damage claim, then notify Thermo Scientific. If any parts are missing, contact one of the Thermo Scientific district offices or the local representative of Thermo Fisher Scientific products. You will find a list of offices on the back cover of this manual.



**DANGER** When servicing the centrifuge, be sure to turn off the POWER switch, turn off the distribution board of your centrifuge room, and wait for at least three minutes before removing covers or tables from the centrifuge to avoid electrical shock hazards.

## Identify the Installation Site



**WARNING** For operator safety, maintain a 30-cm "clearance envelope" around the instrument and keep out of that area while the rotor is spinning. Do not store dangerous substances capable of developing flammable or explosive vapors in the clearance envelope.

When choosing an installation site for the RC6 Plus Centrifuge, consider its dimensions, weight and noise level:

**Table 2-1.** Installation Site

Dimensions	Width: 752 mm
	Depth: 835m (including rear duct assembly)
	Depth: 685m (without rear duct assembly)
	Height: 1112 mm
Weight	350 kg
Noise Level	<64 dB (The maximum noise output with the centrifuge, measured with the compressor on at 0.91 m (3 ft) from the front of the centrifuge and 1.22 m (4 ft) from the floor.
Pollution Degree	2
Over Voltage Category	II



**WARNING** The RC6 Plus Centrifuge weighs 350 kg (772 lb.). Take the necessary precautions when installing and moving the centrifuge to avoid personal injury and/or damage to the centrifuge.

The location for the centrifuge must meet these requirements:

- A flat, vibration-free concrete floor. Avoid installing on a carpeted floor.
- Maximum altitude of 2000 meters.

- The unit is intended for indoor use only. Ambient air temperature at the centrifuge air inlets must be between 2°C to 40°C with maximum relative humidity of 80% at 31°C, linearly decreasing to 50% at 40°C. If the ambient air temperature is above 25°C, the centrifuge may not maintain low temperatures at high speeds, therefore, avoid areas near heat sources (for example, direct sunlight, heating pipes and radiators). Also, avoid close grouping of centrifuges or other heat-producing laboratory equipment.
- Maintain a 30-cm clearance around the centrifuge. Do not store any substances in the clearance envelope.

**Note** The RC6 Plus is a Class A product and is not intended for home use. If used in a domestic environment you must contact your local authorities for authorization.

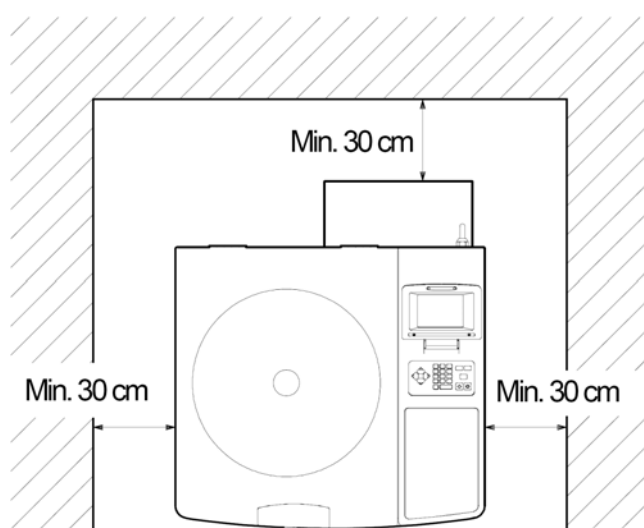

**Figure 2-1.** Clearances for the Centrifuge



**CAUTION** Leave adequate space for airflow around the centrifuge and make sure no vents are blocked. Blocking the airflow entering and/or exiting the centrifuge can result in reduced performance, overheating and possible centrifuge damage.

## Leveling the Centrifuge

1. Turn on the centrifuge power and open the door. (If power supply is not yet available, perform the Emergency Recovery from Power Failure procedure discussed in Chapter 4.)
2. Place the level across the top of the drive spindle.
3. Using a 24 mm wrench, turn each of the four level adjusters until the casters are 5 to 15 mm off the floor.
4. Level the unit by adjusting the level adjusters.
5. When the centrifuge is level, make sure each of the four level adjusters is secure and rattle-free.
6. Secure each of the four level adjusters with the lock nuts.

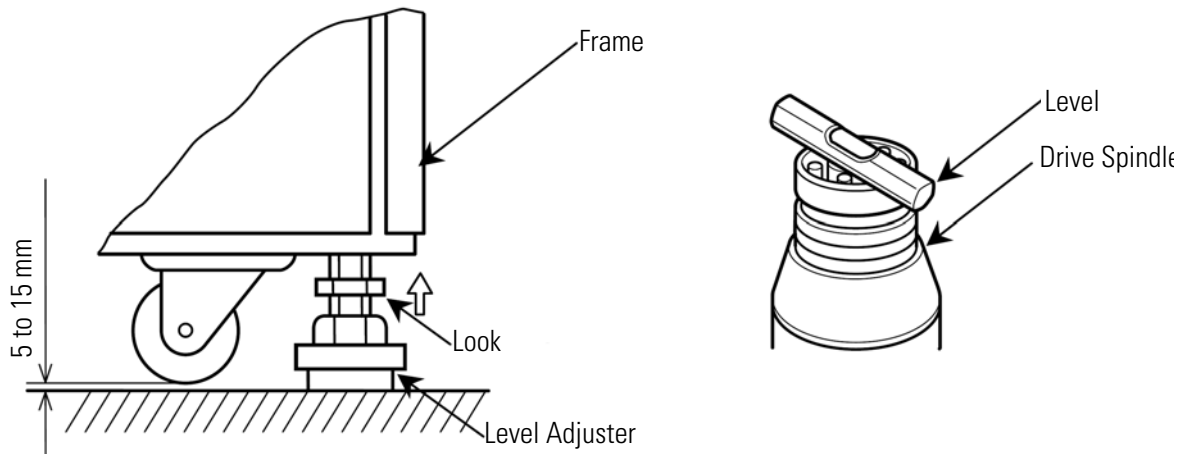

**Figure 2-2.** Leveling the Centrifuge

## Electrical Requirements



**CAUTION** The centrifuge can be damaged if it is connected to the wrong voltage, or if it is connected to a line voltage that varies more than plus/minus 10% of its nominal value. Check the voltage before plugging the centrifuge into any power source. Thermo Fisher Scientific is not responsible for improper installation.

The appropriate power source must be available to plug in the centrifuge. The power supply and outlet type required varies, depending on the rating on the nameplate. Check the nameplate on the back panel of the centrifuge to determine the electrical configuration of your centrifuge, which should be one of the following:

**Table 2-2.** Electrical Requirements

NAME PLATE RATING	SUPPLY REQUIRED
AC208/220/230/240 50/60Hz 21-24A single phase	AC208/220/230/240 50/60Hz 30A single phase (25A single phase may be acceptable depending on you local electrical codes).
AC200 50/60Hz 25A single phase	AC200 50/60Hz 30A single phase
AC400 50/60Hz 2x15A 3 phase	AC400 50/60Hz 2x25A 3 phase

To connect to a different voltage, the centrifuge must be rewired and its plug may also have to be replaced. Contact Thermo Fisher Scientific or your local representative of Thermo Fisher Scientific products. For connection to a different outlet, the power cord may also need to be replaced. Follow local electrical codes.



**WARNING** Your centrifuge must be grounded properly to avoid electrical shock hazards.

Provide an emergency switch (circuit breaker) intended for the centrifuge only, in case of emergency or in the event of failure. It is recommended that the switch is located outside the centrifuge room or near the exit to the room.

**Note** For EMC emission the RC6 Plus is a Class A product. A slow reacting circuit breaker is required because of the high startup current of the compressor.

Plug the power cord coming from the rear of the centrifuge in the terminal of the distribution board. The green/yellow wire is a grounding wire. Your centrifuge must be grounded properly.

Check the supply line voltage with a voltmeter and verify that the voltage indicated on the nameplate is in agreement with the measured line voltage. If the measured line voltage is not within 10% of the voltage specified on the nameplate, do not connect the power cord and operate the centrifuge. Damage to the centrifuge may result. To connect the centrifuge to a voltage other than what is specified on the nameplate (including 3 phase), it will have to be rewired and its power cord may have to be replaced. Contact Thermo Fisher Scientific to have an authorized Thermo Fisher Scientific representative do the rewiring.

Single phase RC6 Plus Centrifuges are equipped with a three- wire power cord with three-prong connector to fit a NEMA 6-30P receptacle or equivalent or, on 230V 50Hz centrifuges, an IEC 60309-type three-pin receptacle (32A, 2-pole and earth). 230V 50Hz poly phase RC-6 Centrifuges are equipped with a four-wire power cord with five-pin connector to fit an IEC 60309-type five-pin receptacle (32 A, 3- pole, neutral and earth).

Provide an emergency switch (circuit breaker) intended for the centrifuge only to turn off the centrifuge power in the event of failure. It is recommended to provide that switch outside of the centrifuge room or near the exit of the centrifuge room.

## Relocation



**CAUTION** Remove the rotor from the rotor chamber before relocating the centrifuge. Be careful not to tip over the unit when moving on uneven or slanted floors.

Installation or relocation of your centrifuge must be done by an authorized authorized Thermo Fisher Scientific representative. Contact Thermo Fisher Scientific or your local representative of Thermo Fisher Scientific products.

Before relocating the centrifuge, unplug the centrifuge and loosen the locking nuts. Lower the casters to the floor by turning the leveling bolts with a wrench. Raise the leveling bolts enough to clear the floor and relocate the centrifuge. After relocation, the centrifuge must be installed and leveled again.

## **2** INSTALLATION

Relocation



## CONTROLS, DISPLAYS & INDICATORS

This chapter describes the RC6 Plus centrifuge controls, displays, and indicators and includes their locations and functions.

### Contents

- “Controls, Displays, & Indicators” on page 3-2
- “Operation Panel” on page 3-2
- “POWER Switch” on page 3-5
- “Diagnostic Indicators Safety Device” on page 3-6

# Controls, Displays, & Indicators

The RC6 Plus control keyboard is used to select desired run parameters. During a run, digital displays indicate set and actual run conditions, such as estimated sample temperature, rotor speed, remaining run time or accumulated integral value.

## Operation Panel

The operation panel of the RC6 Plus Superspeed centrifuge is composed of a display panel and function keys. The liquid crystal display can be tilted back and forth for easy viewing. The display panel shows various screen displays such as programmed operation, rotor list and user customization in addition to the basic screen (RUN SCREEN) (see Figure 3-1).

The display automatically turns to the ZOOM SCREEN (see Figure 3-2) when 20 seconds have passed after reaching the set speed. The ZOOM screen returns to the RUN SCREEN by pressing any key on the panel or when the rotor starts deceleration.

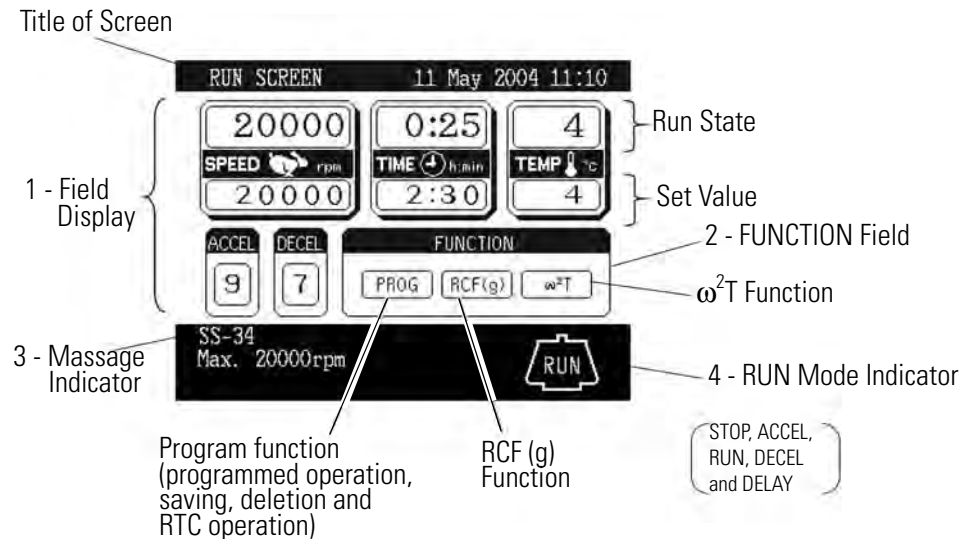

**Figure 3-1.** Display Panel

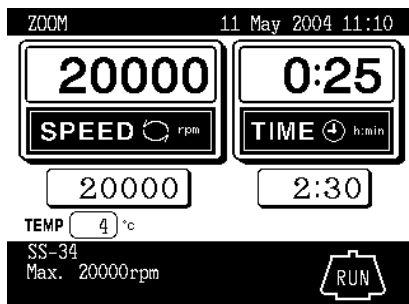

**Figure 3-2.** Zoom Screen

Table 3-1.



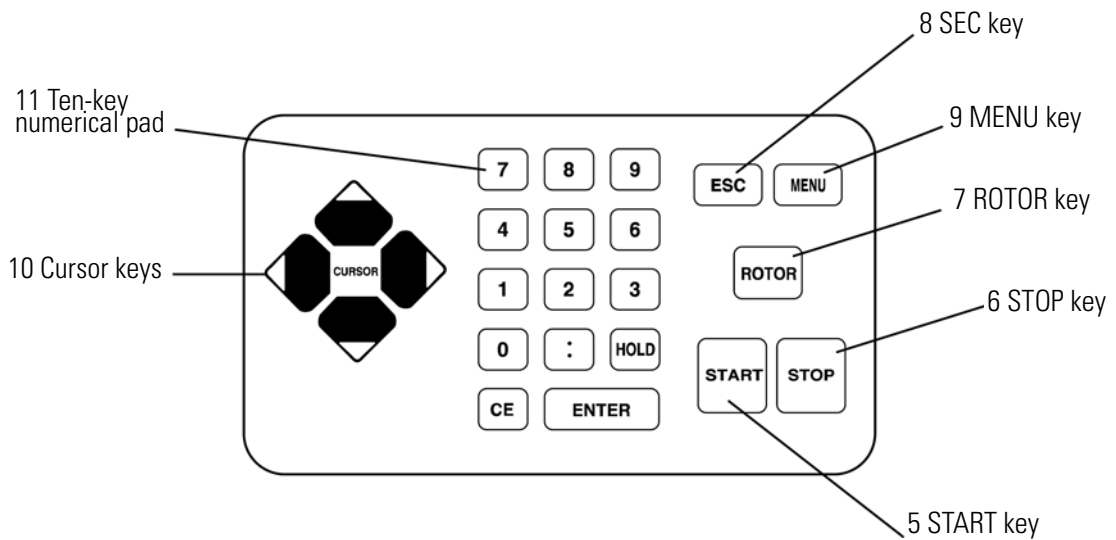



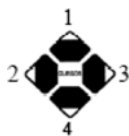

No	Name	Display Panel Function (refer to Figure 3-1)
1	Field display	<p>Displays the following run conditions.</p> <p>For SPEED, TIME and TEMP displays, the upper line shows the actual run state and the lower line shows the set value. Refer to Setting Run Conditions for details.</p> <ul style="list-style-type: none"> <li>• SPEED (Speed display) <ul style="list-style-type: none"> <li>(Upper line) Displays rotor speed in increments of 10 rpm under 10,000 rpm and increments of 100 rpm over 10,000 rpm.</li> <li>(Lower line) Displays rotor speed in increments of 10 rpm under 10,000 rpm and increments of 100 rpm over 10,000 rpm. Set speed range is from 300 rpm to 22,000 rpm.</li> </ul> </li> <li>• TIME (Run time display) <ul style="list-style-type: none"> <li>(Upper line) Displays remaining run time during operation. If HOLD is selected, displays elapsed run time.</li> <li>(Lower line) Run time range is from 1 minute to 99 hours, 59 minutes in increments of 1 minute.</li> </ul> </li> <li>• TEMPERATURE (Temperature display) <ul style="list-style-type: none"> <li>(Upper line) Displays rotor temperature in increments of 1 degree centigrade.</li> <li>(Lower line) Temperature range is from - 20 degrees centigrade to 40 degrees centigrade in increments of 1 degree centigrade.</li> </ul> </li> <li>• ACCEL (Acceleration rate display) Displays 1 to 9 acceleration rates.</li> <li>• DECEL (Deceleration rate display) Displays 1 to 9 deceleration rates and free coast (0).</li> </ul>
2	FUNCTION field	<ul style="list-style-type: none"> <li>• PROG Used to save run conditions for programmed operation.</li> <li>• RCF Used to display and set RCF value.</li> <li>• <math>\omega^2T</math> Used to display and set for integrator operation.</li> </ul>
3	Message indicator	Displays alarm message, prompt and rotor model.
4	RUN mode indicator	<p>Displays operating mode with illustration of a rotor.</p> <p>Operating modes are as follows:</p> <p>STOP, ACCEL, RUN (Displayed when rotor is rotating at set speed), DECEL And DELAY (Displayed up to RTC operation is started)</p>



**Figure 3-3.** Function Keys

No	Name	Key Function (refer to Figure 3-3)
5	START key	Starts the centrifuge run.
6	STOP key	Stops the centrifuge run.
7	ROTOR key	Used to display rotor list or to enter desired rotor number.
8	ESC key	Used to return to the previous screen. (e.g., from MENU screen to RUN SCREEN)
9	MENU key	Displays MENU screen. You can select user customization, or alarm information.
10	Cursor keys	<p>(1) Makes the RUN SCREEN ready-to-enter state.</p> <p>(2) Moves the cursor on the screen.</p> <ol style="list-style-type: none"> <li>1. Moves the cursor upward (↑).</li> <li>2. Moves the cursor left (←).</li> <li>3. Moves the cursor right (→).</li> <li>4. Moves the cursor downward (↓).</li> </ol>



No	Name	Key Function (refer to Figure 3-3)
11	Ten-key	Used to set run conditions with numeric values.
	numerical pad	At time setting : switches between hours and minutes. At temperature setting : Used to enter a minus sign. At $\omega^2T$ value setting : switches between integer and mantissa. At run time setting: used to set continuous operation.
		 At temperature setting : Used to enter a minus sign.
		At $\omega^2T$ value setting : switches between integer and mantissa.
		At run time setting: used to set continuous operation.
		Used to clear typing errors and alarm messages.
		(1) By pressing the CE key, the entered value on the line where the cursor stays is cleared and the cursor returns to the previous position.
		(2) By pressing the CE key, displayed alarm message is cleared. If two or more alarm messages are displayed at a time, clear them one by one. (Refer to Corrective Actions for details.)
		Used to fix the entered value.
		

## POWER Switch

The POWER switch is located in the upper right-hand corner of the front cabinet panel. The switch is an ON/OFF toggle switch, when set to ON applies electric power to the centrifuge.



**CAUTION** Always keep the liquid crystal panel in a visible position while the POWER switch is turned on so that you can check the current operating state.

" I " : ON  
" O " :OFF

Do not position the centrifuge so that the movement of the POWER switch may become difficult.

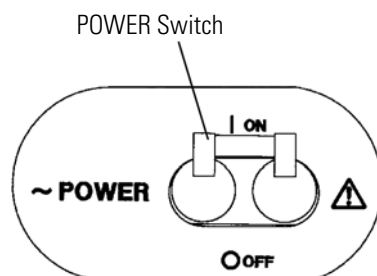

Figure 3-4. POWER switch

## **Diagnostic Indicators Safety Device**

### **Protection of Rotor Chamber**

The rotor chamber allows the rotor to rotate at high speeds. A steel protector is provided around the chamber for the operator's safety in case of any rotor mishap during centrifugation.

### **Imbalance Detector**

This centrifuge is equipped with a sensor that detects severe vibration of the rotor due to improper bucket setting or excessive imbalance, and decelerates the rotor. If an imbalance is detected, the run will be terminated and IMBALANCE will be displayed.

### **Door Lock**

For safety reasons, the door is automatically locked while the rotor is rotating. The locked state is held even if the instrument power is turned off. The door can be opened/closed only when the rotor stops.

## OPERATION

This chapter provides step-by-step instructions on how to set the centrifuge power ON, open the chamber door, and perform a run in the normal mode. It also describes how to precool the rotor. Read and observe the Important Safety Information supplied on page iii at the front of this manual.

The chapter contains supplementary information on how to calculate relative centrifugal force (RCF); how to do a test run for low speed and low temperature operation; and what will cause an ENTRY ERROR.

### Contents

- “Reducing Speed for Loads in Excess of Design Mass” on page 4-2
- “Basic Operation” on page 4-2
- “Normal Operating Procedure” on page 4-7
- “Saving and Changing Run Conditions” on page 4-10
- “Step-mode Operation” on page 4-13
- “RTC (Real Time Control) Operation” on page 4-14
- “Displaying and Setting RCF” on page 4-17
- “Displaying and Setting w2T” on page 4-19
- “Emergency Recovery from Power Failure” on page 4-20
- “Features on Menu Screen” on page 4-22
- “Lockout system function (optional)” on page 4-24

The controls and displays referred to in this chapter are described in detail in Chapter 3.

## Reducing Speed for Loads in Excess of Design Mass

**WARNING**

1. Use specified Thermo Fisher Scientific rotors only.
2. Do not use corroded, scratched or cracked rotors, buckets and assemblies. Check that the rotor, buckets and assemblies are free of such abnormalities before operation.
3. Do not exceed the maximum rated speed of the rotor or buckets in use.
4. Failure to reduce rotor speed when compartment load exceeds maximum allowable compartment load can lead to rotor failure and result in personal injury and/or centrifuge damage.

Each rotor has a maximum allowable compartment mass (defined in Appendix and in the rotor manual). To prevent rotor failure, the total contents of any compartment, including specimen, tubes, sealing assembly and adapters must not exceed the specified maximum compartment mass unless rotor speed is reduced proportionately. Strict adherence to the maximum allowable compartment mass or reduced rotor speed is required to prevent rotor failure.

If the maximum compartment mass is greater than value specified for the rotor, use the following formula to determine the reduced rotor speed required:

$$\text{Reduced Speed} = \text{Maximum Rotor Speed} \sqrt{\frac{\text{Maximum Compartment Load}}{\text{Actual Compartment Mass}}}$$

## Basic Operation

**WARNING**

1. Failure to load and install the rotor in accordance with the instructions in the rotor operating guide could result in damage to the centrifuge. The rotor cover must be on and locked in place and the rotor must be locked on to the drive spindle.
2. Use specified Thermo Fisher Scientific rotors **ONLY**.
3. Do not incline or move the instrument while the rotor is spinning.
4. Do not place any object on the instrument or lean on the instrument while the rotor is spinning.

This section describes how to perform a basic run, how to set run conditions on the RUN SCREEN and how to use the cursor keys.

1. Set the main power switch ON.
2. Open the chamber door.
3. Install the rotor:



- Wipe the rotor centerhole and spindle surfaces clean to reduce the chance of the rotor sticking to the spindle.
  - If applicable, make sure the rotor cover is installed.
  - Place the rotor on the drive spindle and lock it in place turning the rotor locking knob counterclockwise.
4. Close the chamber door.
  5. Set the Run Screen as follows.

## RUN Screen



### CAUTION

1. Do not tilt the display panel forcibly or, mechanical components can be damaged.
2. Do not press the function keys with a sharp-pointed object such as a ballpoint pen.
3. If an abnormal sound is heard during the operation, stop the operation immediately and contact Thermo Fisher Scientific or your local representative of Thermo Fisher Scientific products.

The RUN SCREEN shows the set and actual run conditions.

The speed (SPEED), time (TIME) and temperature (TEMP) displays have a two-line display.

The upper line shows the actual run state and the lower line shows the set value.

The acceleration (ACCEL) and deceleration (DECEL) displays show the set value.

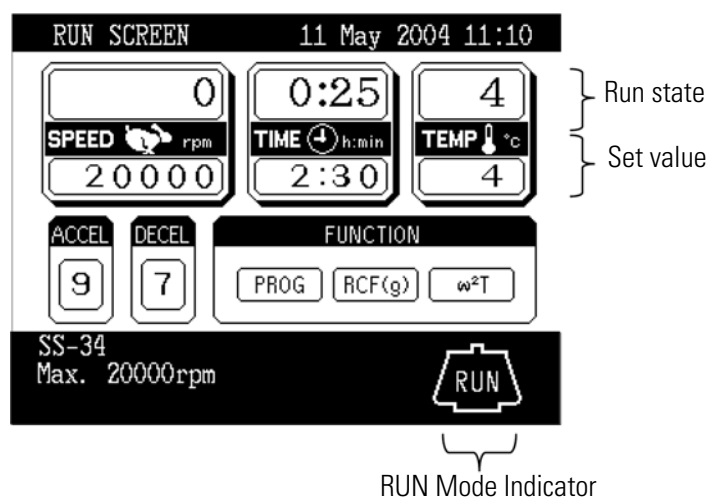

**Figure 4-1.** RUN Screen



**WARNING** Do not leave rotors or other objects on centrifuge surfaces during operation.

## Cursor Keys

A cursor appears and blinks on the entry line of a run condition display by pressing a cursor key as shown in Figure 4-2.

The entry line state varies depending on the presence of cursor as shown below.

1. Fixed-entry state: No cursor appears in normal state.
2. Ready-to-enter state: By pressing any of the four cursor keys in fixed-entry state, a cursor appears blinking "0" (or other numeric value) on the entry line. Desired numeric values can be entered in this state. Press the cursor keys to move the cursor.

To set desired run conditions, put the RUN SCREEN in the ready-to-enter state. Move the cursor to the desired item and enter a numeric value. If no numeric value is entered in ready-to-enter state for 30 seconds or more, the display automatically turns to fixedentry state.

**Note** To enter desired value when the entry line is fixed-entry state (e.g., the state of RUN SCREEN after turning on the POWER switch), press any of the four cursor keys to show a blinking cursor and move the cursor to the desired item with cursor keys. The cursor keys have two functions. One is to show a cursor on the screen and the other is to move the cursor. The cursor on the screen can be moved up, down, left and right according to the arrow marks on the cursor keys.

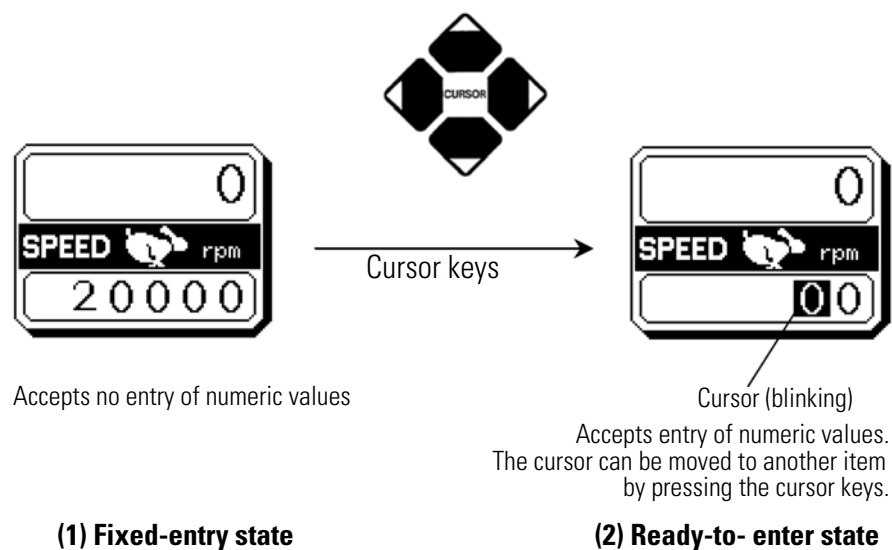

Figure 4-2. Entry Line State

## Designating the Rotor

Before operation, the rotor used must be designated according to the following procedure. This centrifuge does not start operation unless a rotor is designated. This centrifuge performs optimum temperature compensation and maximum speed checking for the designated rotor.

**Step Key Operation Screen Display and Notices**

1 Press the ROTOR key on the KEY BOARD.

Enter the rotor number to be used with the ten-key numerical pad and press the ENTER key. (The screen turns to the next page by pressing the cursor key.)

The screen returns to the RUN SCREEN.

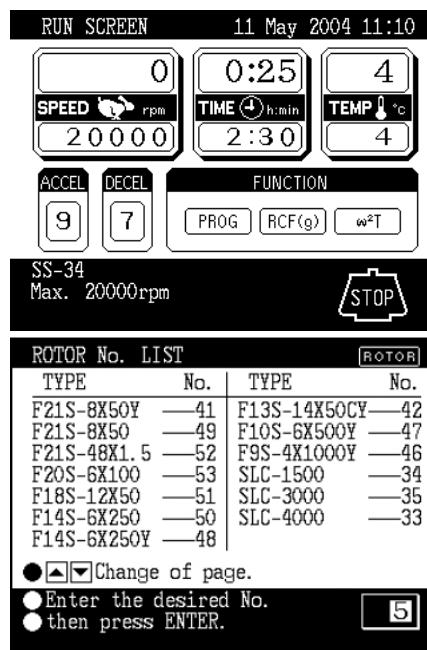





1. When setting two or more run conditions, there is no need to press the ENTER key after each setting. The set value is entered by pressing a cursor key and the cursor moves to the new item in ready-to-enter state.
2. If changing the TIME setting during continuous operation (HOLD), enter a value adding the desired remaining time to the elapsed time. For example, to stop the operation after 1 hour and 30 minutes when 5 hours have elapsed in continuous operation, turn the TIME display to ready-to-enter state by pressing a cursor key and enter as follows.

## Setting RUN Conditions

The table below exemplifies how to set run conditions such as rotor speed, run time and rotor temperature.

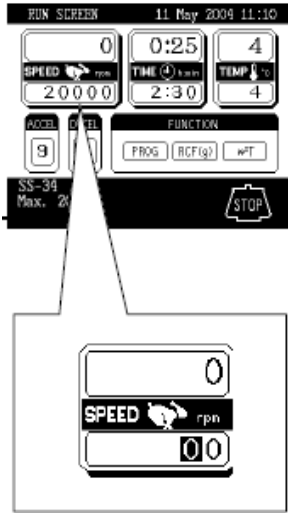
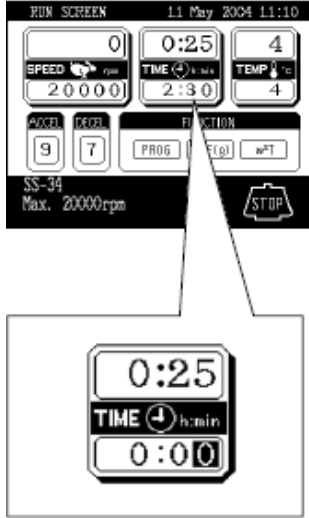
## 4 OPERATION

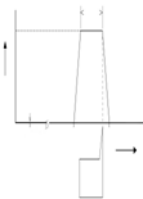
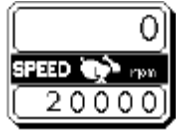
### Basic Operation

Item	Speed (SPEED) 20,000 rpm	Run Time (TIME) 2 hours, 30 minutes
<b>Example set value</b>		
1 Press a cursor to turn the display to ready-to-enter state.	The display turns to ready-to-enter state.	The display turns to ready-to-enter state.
2 Move the cursor to the desired item by pressing the cursor keys. (The arrow marks on the cursor keys indicate cursor directions.)		
3 The cursor blinks on the entry line for 30 seconds. The display is now ready-to-enter state.		
4 Enter the desired value with the ten-key numerical pad.	 The last zero (0) need not be entered.	 The cursor can be moved to the hours setting position by pressing the cursor left key. For continuous run, press the HOLD key.
 Entered numerals are shifted to the left in order.		
5 Check the setting and fix it by pressing the ENTER key. Setting can also be fixed by pressing a cursor key. The CE key is used to cancel the setting.	The speed setting is "20,000 rpm". 	The run time setting is "2:30 (2 hours 30 minutes)". 
6 Press the START switch.		
7 After the rotor has come to a stop, lift the door handle. Then remove the rotor.		
Setting range	300 rpm to the maximum speed: in increments of 10 rpm under 10,000 rpm, and in increments of 100 rpm over 10,000 rpm	1 minute to 99 hours 59 minutes: in increments of 1 minute

Procedure

**Note** Keep the chamber door closed after the rotor has been removed to inhibit the formation of condensation on the chamber walls. To repeat the run with the same speed, time and temperature parameters, install the rotor, close the chamber door, press START and then press ENTER.

Temperature (TEMP) 4 degrees centigrade	Acceleration Rate (ACCEL) 9	Deceleration Rate (DECEL) 7
--	--------------------------------	--------------------------------

The display turns to ready-to-enter state.

The display turns to ready-to-enter state.

The display turns to ready-to-enter state.

The cursor is blinking at the single digit position.

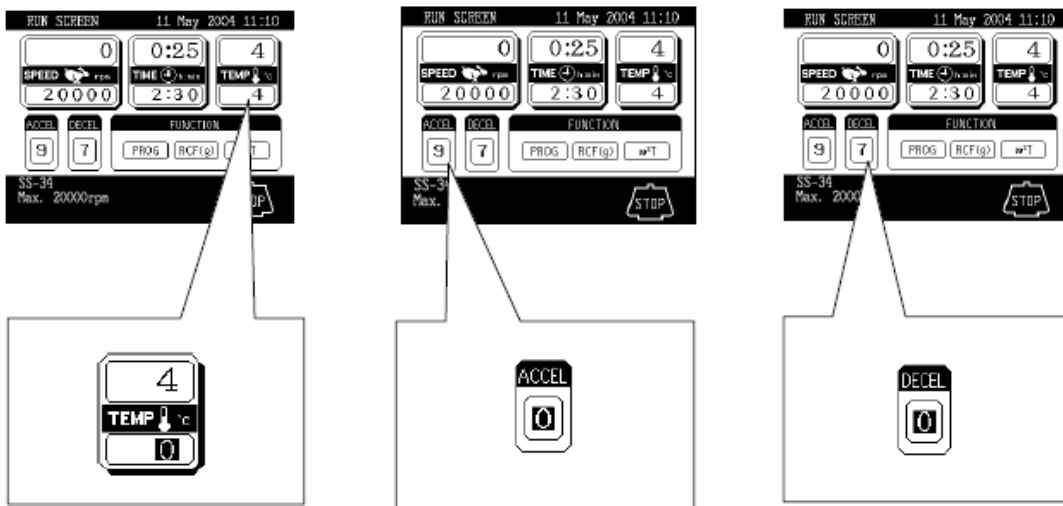

4

9

7

Enter "0" for selecting free coast.

The temperature setting is "4 degrees centigrade".

The acceleration rate setting is "9".

The deceleration rate setting is "7".



-20 degrees centigrade to 40 degrees centigrade: in increments of 1 degree centigrade

1 to 9

1 to 9 and 0 for free coast

## Normal Operating Procedure

This section describes the procedure for normal operation.

**Note** Before following the procedure, read the rotor instruction manual carefully and make sure that you have selected the appropriate type of tube for the sample, and that the amount of sample in the tubes is correct.

Step	Procedure	State of Centrifuge and Notices
1	Turn ON the POWER switch of the centrifuge.	<ul style="list-style-type: none"> <li>The panel indicators turn on.</li> <li>The door lock is released.</li> </ul>
2	Mount the rotor.	<ul style="list-style-type: none"> <li>Mount the rotor on the drive spindle properly and tighten the rotor locking knob securely.</li> <li>Press the ROTOR key and enter the correct rotor number.</li> </ul>
3	Set run conditions.	<ul style="list-style-type: none"> <li>Set run conditions referring to Set Run Conditions.</li> </ul>
4	Press the START key.	<ul style="list-style-type: none"> <li>The rotor starts rotating and the timer starts counting.</li> <li>The rotor accelerates up to the set speed.</li> </ul>
5	The set run time has elapsed or the STOP key is pressed.	<ul style="list-style-type: none"> <li>The rotor starts decelerating.</li> </ul>
6	The rotor stops.	<ul style="list-style-type: none"> <li>The centrifuge makes a beep to notify that the rotor has stopped.</li> </ul>
7	Remove the rotor.	<ul style="list-style-type: none"> <li>Wait until the rotor stops completely and then remove the rotor.</li> </ul>

The RUN mode indicator is displayed on the panel as follows:

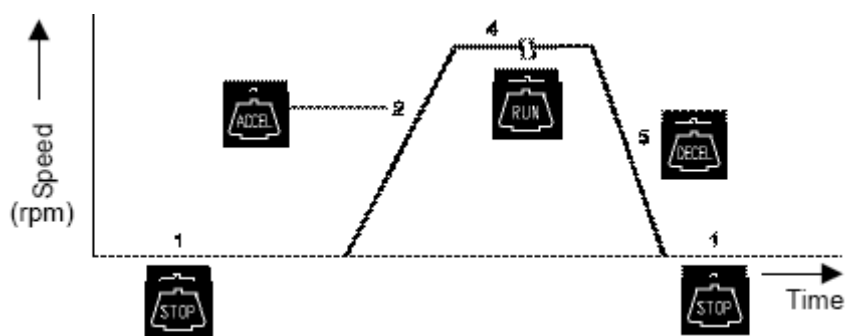

**Figure 4-3.** RUN Mode Indicator

## Acceleration Rate and Deceleration Rate

The acceleration and deceleration rates can be adjusted for a wide range of use. The figure below shows how a rotor accelerates and decelerates in compliance with a code number selected from 1 through 9.

Code No.	Time for acceleration from 0 to 500 rpm	Time for deceleration from 500 to 0 rpm
9	Minimum*	Minimum**
8	30 sec.	1 min.
7	45 sec.	2 min.
6	1 min.	3 min.
5	2 min.	4 min.
4	3 min.	6 min.
3	4 min.	9 min.
2	6 min.	12 min.
1	10 min.	15 min.
0	-	Coasting deceleration from set speed

\*The minimum time is the one that occurs when the rotor is being accelerated or decelerated with the maximum torque of the driving motor. This time varies with the type of rotor in use.

\*\*The minimum time is the one that occurs when the rotor is being accelerated or decelerated with the maximum torque of the driving motor. This time varies with the type of rotor in use.

**Note** These time values vary with the type of rotor in use.

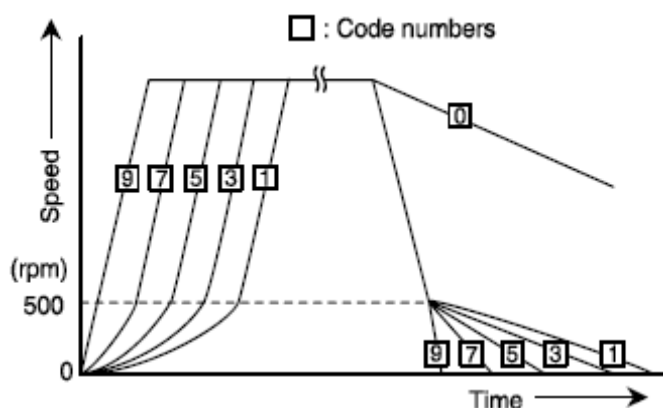

Figure 4-4. Acceleration and Deceleration Rates

## FUNCTION Field



Figure 4-5. Function Field

The RC6 Plus Superspeed centrifuge has many add-on features such as programmed operation and centrifugal force values displaying and setting. These features are displayed and selected on the FUNCTION field.

PROG : You can save run conditions in memory for later use in repeated operation.

This feature also allows step-mode operation (three normal operations can be combined in a sequence of operations).

RCF : The centrifuge automatically computes and displays RCF values from set speed, or speed from set RCF values.

$\omega^2T$  : The centrifuge automatically computes and displays run time from set speed and  $\omega^2T$  set value.

## Programmed Operation

Programmed operation capability is an add-on feature that saves set run conditions in memory for later use. This feature allows you to save frequently used run conditions in memory and then recall the saved run conditions whenever you need them, thus making the operation procedure simple. (Even when the POWER switch is turned off, the saved run conditions remain in memory.) The memory in the centrifuge can contain 30 sets of run parameters.

## Saving and Changing Run Conditions

To save or change run conditions in memory, use the following procedure.

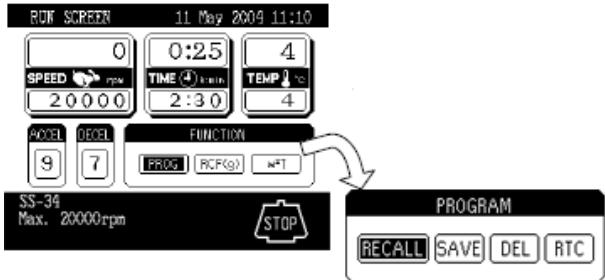
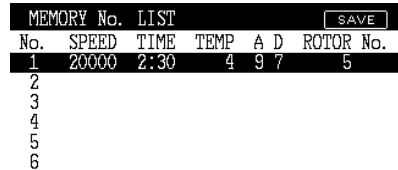
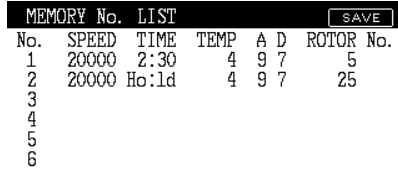
Step	Key operation	Screen display and notices
1	Move the cursor to PROG and press the ENTER key.	<p>The FUNCTION field turns to the PROGRAM field.</p> 
2	Press the cursor key to move the cursor to SAVE and press the ENTER key.	<p>The screen turns to the MEMORY No. LIST screen.</p>  <ul style="list-style-type: none"> <li>● ▲▼◀▶ Change of page.</li> <li>● Confirm Memory Location?</li> <li>● Enter The Desired No. <span style="border: 1px solid black; padding: 2px;">1</span></li> <li>● Then Press ENTER.</li> </ul> <p>A setting parameter of the RUN SCREEN is temporary saved at first memory area.</p>
3	Enter the desired MEMORY No. to be saved with the ten-key numerical pad and press the ENTER key. (e.g.: saving run conditions at MEMORY No.1) <span style="border: 1px solid black; padding: 2px;">1</span> <span style="border: 1px solid black; padding: 2px;">ENTER</span>	<p>The cursor moves to the desired MEMORY No.</p>  <ul style="list-style-type: none"> <li>● ▲▼◀▶ Change of page.</li> <li>● Enter next memory No. or</li> <li>● press ESC to exit. <span style="border: 1px solid black; padding: 2px;">□</span></li> </ul>



**Step Key operation Screen display and notices**

When other conditions are saved, select the desired memory No. (.g.: at MEMORY NO.2)

**2** **ENTER**

And enter run conditions as follows.

e.g.: SPEED: 20,000 rpm  
 TIME: HOLD  
 TEMP: 4 degrees centigrade  
 ACCEL: 9  
 DECEL: 7  
 ROTOR No.: 25 (F20/MICRO)

**2 0 0 0** **▶**  
**HOLD** **▶**  
**4** **▶**  
**9** **▶**  
**7** **▶**  
**2 5** **ENTER**

4

The run conditions are saved at MEMORY No. 2.

MEMORY No. LIST							SAVE
No.	SPEED	TIME	TEMP	A	D	ROTOR No.	
1	20000	2:30	4	9	7	5	
<b>2</b>	<b>00</b>						
3							
4							
5							
6							

● Enter the run conditions  
 ● then press ENTER.

MEMORY No. LIST							SAVE
No.	SPEED	TIME	TEMP	A	D	ROTOR No.	
1	20000	2:30	4	9	7	5	
2	20000	Ho:ld	4	9	7	25	
3							
4							
5							
6							

● **▲▼◀▶** Change of page.  
 ● Enter next memory No. or  
 ● press ESC to exit.

- The screen turns to RCF and g.sec values entry screen by pressing the cursor key.

After saving run conditions, press the ESC key twice.

- The PROGRAM field appears by the first press of the ESC key.

5

RUN SCREEN 11 May 2004 11:10

SPEED rpm 20000	TIME h:min 0:25 2:30	TEMP °C 4 4
ACCEL 9	DECEL 7	PROGRAM RECALL SAVE DEL RTC

SS-34 Max. 20000rpm STOP

- The FUNCTION field appears by the second press of the ESC key.

RUN SCREEN 11 May 2004 11:10

SPEED rpm 20000	TIME h:min 0:25 2:30	TEMP °C 4 4
ACCEL 9	DECEL 7	FUNCTION PROG RCF(g) ω²T

SS-34 Max. 20000rpm STOP

## 4 OPERATION

### Saving and Changing Run Conditions

#### Note

1. When the saved run conditions are changed, the previous run conditions are cleared and the newly saved run conditions are in effect.
2. Run conditions cannot be saved while the rotor is rotating. Check that the rotor stops completely before saving run conditions.

## Using Programmed Operation

To recall the saved run conditions and use programmed operation with the recalled run conditions, take the following procedure.

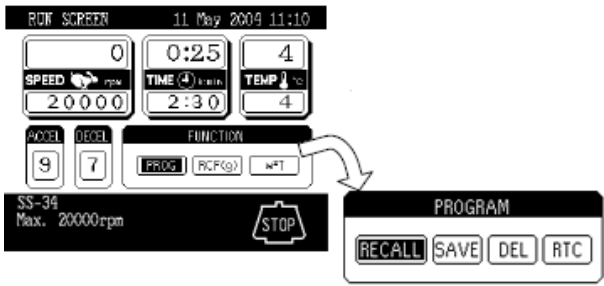
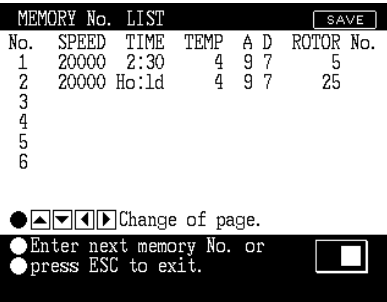
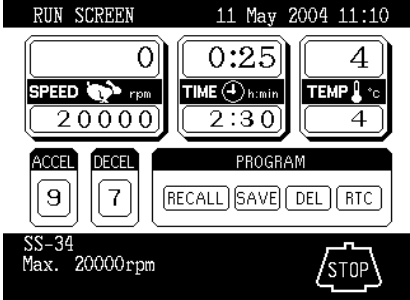
Step	Key operation	Screen display and notices
1	Move the cursor to PROG and press the ENTER key.	<p>The FUNCTION field turns to the PROGRAM field.</p> 
2	Press the ENTER key when the cursor stays on CALL.	<p>The screen turns to the MEMORY No. LIST screen.</p>  <p>● ▲ ▼ ◀ ▶ Change of page. ● Enter next memory No. or ● press ESC to exit.</p>
3	Enter the desired MEMORY No. with the ten-key numerical pad and press the ENTER key. (e.g.: recalling run conditions saved at MEMORY No. 2) <b>2</b> <b>ENTER</b>	<p>The recalled run conditions are displayed. The MEMORY No. appears on the message display.</p>  <p>Only the saved MEMORY No. can be recalled.</p>
4	Mount the rotor and press the START key.	<ul style="list-style-type: none"> <li>• The rotor starts rotating.</li> <li>• When reentering (changing) a run condition of the recalled MEMORY No. (e.g., SPEED), the MEMORY No. is canceled. Recall the MEMORY No. again if necessary.</li> <li>• The MEMORY No. cannot be changed (or recalled) while the rotor is rotating.</li> </ul>

## Step-mode Operation

This centrifuge has the step-mode operation capability that allows you to save three different sets of values for a run parameter set in a single memory location (MEMORY Nos. 31 - 33, 41 - 43, and 51 - 53) and then change some or all of the run conditions (e.g., speed, run time, rotor temperature, etc.) for each step during a step-mode run. Save step-mode run conditions at the MEMORY Nos. 31 - 33 (41 - 43 or 51- 53) in accordance with "3-3-1 Programmed Operation (1)".

When the MEMORY No. 31 is recalled, the centrifuge automatically performs step-mode operation in order of MEMORY Nos. 31, 32 and 33.

### Procedure for step-mode operation

Example

The table below shows the run parameters and their values required for an example 3-step run (MEMORY Nos. 31 to 33). Fig. 4-6 depicts how the example run will proceed.

	1st step (Memory No. 31)	2nd step (Memory No. 32)	3rd step (Memory No. 33)
Speed	1000 rpm	20000 rpm	5000 rpm
Run time	30 min	60 min	10 min
Temperature	4°C	4°C	4°C
Accel rate	9	9	9
Decel rate	9	9	7
Rotor No.	05	05	05

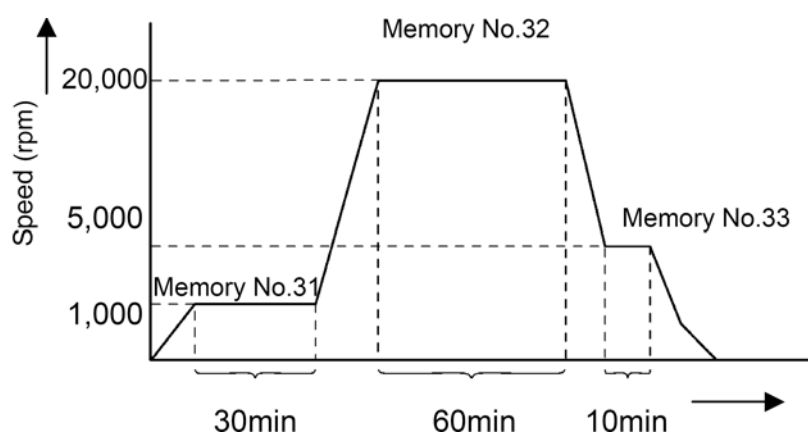

**Figure 4-6.** Details of an example step-mode operation

#### Note

1. Select the same rotor number for each step. Otherwise, alarm message "ROTOR NO." is indicated and the centrifuge stops operation. (Contents of the memory cannot be called up.)
2. Use the MEMORY Nos. 32 and 33 (42 and 43 or 52 and 53) for the step-mode operation with two steps.

## RTC (Real Time Control) Operation

The RC6 Plus Superspeed Centrifuge can be programmed to perform automatic centrifugation by setting the incorporated time clock to start and end centrifugation at the desired time in advance. This is the RTC (Real Time Control) operation, also referred to as delayed start/stop.

Figure 4-6 illustrates an example of procedure for RTC operation.

Example: The rotor is loaded in the centrifuge and the run conditions listed below are set in the evening on May 11, to end the operation about 9:30 a.m. next morning.

1	Rotor	SS-34
2	Speed	18,000 rpm
3	Run time	60 minutes
4	Temperature	4 degrees centigrade
5	Acceleration rate	9
6	Deceleration rate	7

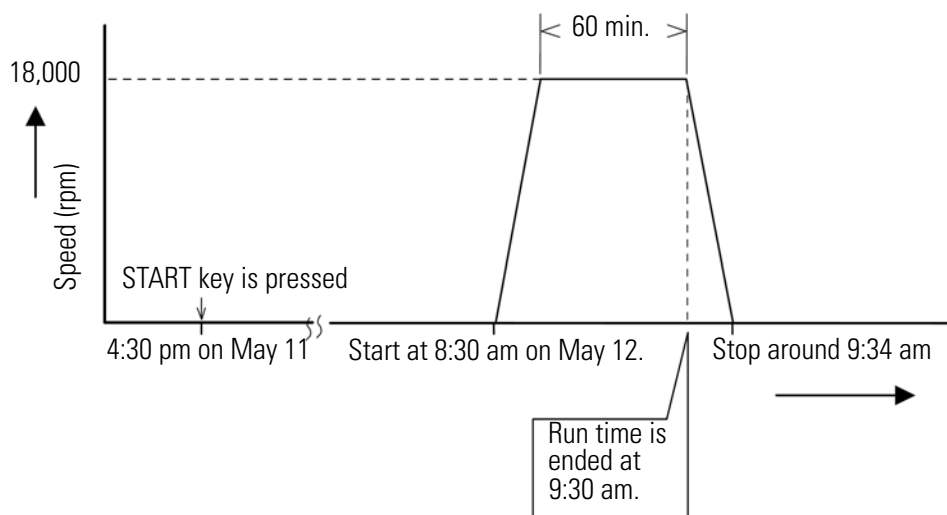
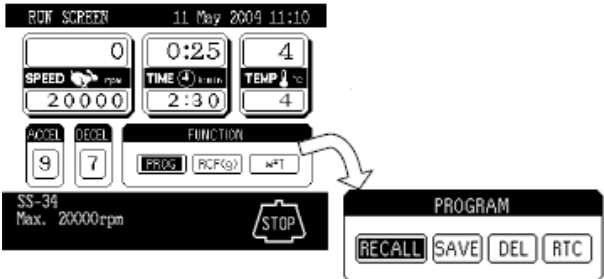



**Figure 4-7.** Example of RTC Operation

In this example, the above run conditions from (2) to (6) are set first and then the designated time to complete the RTC operation, 9:30 a.m. on May 12. Then the START key is pressed.





(Otherwise, the same RTC operation can be achieved by setting the designated time to start centrifugation, 8:30 a.m. on May 12.)

## Procedure for RTC Operation

Step	Key operation	Screen display and notices
1	Set the run conditions.	<ul style="list-style-type: none"> <li>Set the run conditions referring to <i>Setting Run Conditions</i>.</li> <li>For time setting, do not select HOLD but enter a numeric value.</li> </ul>
2	Move the cursor to PROG and press the ENTER key.	<p>The FUNCTION field turns to the PROGRAM field.</p> 
3	Press the cursor key three times to move the cursor to RTC and press the ENTER key.	<p>The screen turns to the RTC operation setting screen.</p> 
4	<p>Select the desired item.</p> <p>When selecting "1: Setting stop time", press the following keys.</p> <p><b>1</b> <b>ENTER</b></p>	<p>The cursor is blinking on "day" column.</p> <p>The date (month and day) is automatically displayed.</p> 

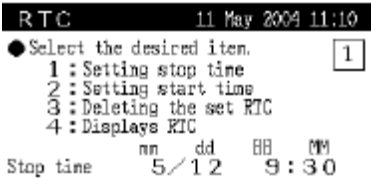
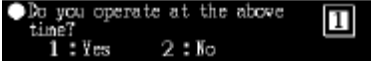
## 4 OPERATION

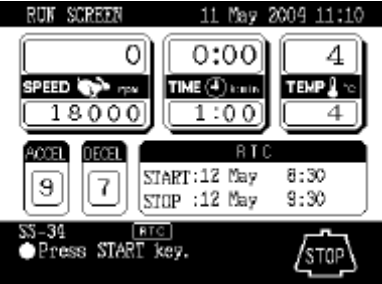
### RTC (Real Time Control) Operation

Step	Key operation	Screen display and notices
	Enter the desired date and time (month, day, hour and minutes) using the cursor keys and the ten-key numerical pad. Press the ENTER key.	
5		 <ul style="list-style-type: none"> <li>• The range for "hour" setting is from 0 to 23 (24-hour display).</li> <li>• Do not enter any date and time that passed the current time.</li> <li>• Set a proper stop time considering the centrifugation time so that the start time will be later than the current time.</li> <li>• It is not possible to set an operation that will start 20 days or more from the current time.</li> </ul>
6	<p>Select Yes or No in response to the prompt.</p> <p>"Yes": </p> <p>"No": </p>	<ul style="list-style-type: none"> <li>• When selecting "Yes":</li> </ul>  <ul style="list-style-type: none"> <li>• The screen turns to the RUN SCREEN and the RTC time is displayed.</li> <li>• RTC appears on the message indicator.</li> <li>• When selecting "No", the display turns to the screen of Step 2. Enter the desired setting again.</li> </ul>
7	<p>Check the RTC setting on the RUN SCREEN and press the START key.</p>  <div style="border: 1px solid black; padding: 5px; width: fit-content;"> <p>RTC operation will not start unless the START key is pressed.</p> </div>	<ul style="list-style-type: none"> <li>• Perform operation according to <i>Operating Procedure</i>.</li> <li>• Note that the run time setting cannot be changed after setting the RTC operation. Clear the RTC setting and then reset the run time if necessary.</li> <li>• The centrifuge turns to "DELAY" mode by pressing the START key and wait until the set time. The centrifuge automatically starts operation at the set time and keeps operation during the designated time.</li> </ul>  <ul style="list-style-type: none"> <li>• The RUN mode indicator on the panel turns to "DELAY".</li> </ul>

1. The RUN mode indicator on the panel turns as follows in RTC operation.

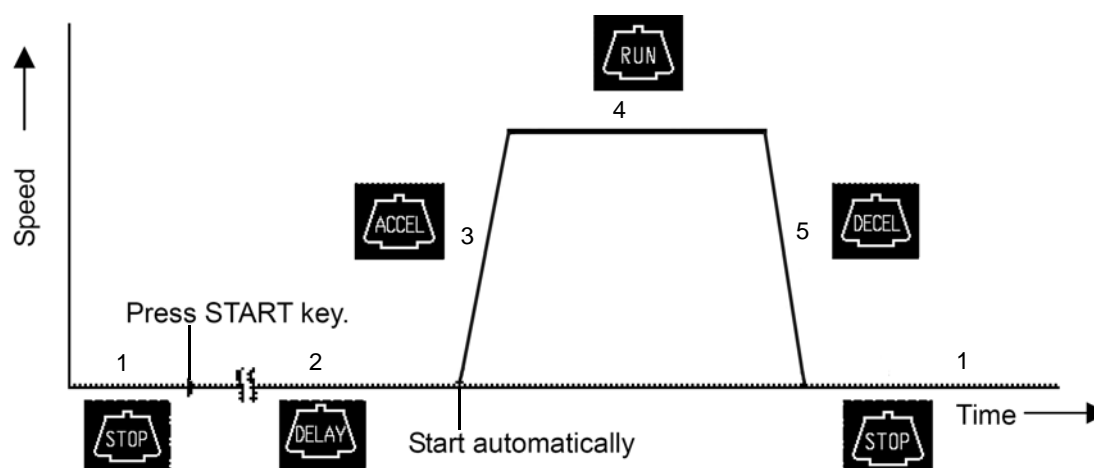

**Figure 4-8.** Operating Mode (RTC)

2. Note that the RTC setting is not available in the following cases:
  - i. The time setting on the RUN SCREEN is "HOLD" (continuous run).  
Change the run time setting from "HOLD" to a desired numeric value.
  - ii. The start time has already passed.  
Change the setting so that the start time will be later than the current time.
  - iii. The start time is 20 days or more from the current time.  
Change the setting so that the start time will be within 20 days.
3. Clear the RTC setting and then reset the run time if it is necessary to change the run time setting after setting the RTC operation.
4. Recall the saved run conditions and enter the RTC setting when performing the programmed operation (including the step-mode operation) and the RTC operation in combination. The centrifuge automatically computes the total run time of all steps in the programmed operation and also the start time for RTC operation. Note that the saved run conditions cannot be recalled after setting the RTC operation.
5. Press the STOP key to stop the operation. The RTC operation is stopped and the rotor stops.
6. When performing the RCF operation and the RTC operation in combination, enter the RCF setting first then enter the RTC setting. (See *Displaying and Setting RCF*.)
7. When performing the  $\omega^2T$  operation and the RTC operation in combination, enter the  $\omega^2T$  setting first then enter the RTC setting. (See *Displaying and Setting  $\omega^2T$* .)

## Displaying and Setting RCF

The RC6 Plus Superspeed centrifuge, has in its internal memory, data representing the maximum radii of all available rotors. Based on this data, the centrifuge automatically computes relative centrifugal force (RCF) values from set speed, or speed from set RCF values, and then displays the result on the control panel. This section explains how to use this RCF displaying and setting capability of the centrifuge.

## 4 OPERATION

### Displaying and Setting RCF

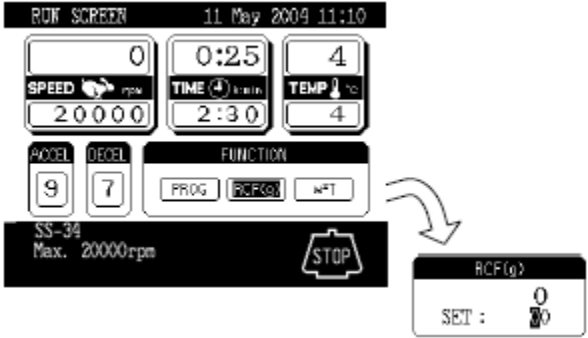
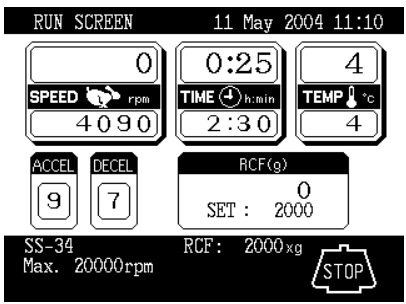
Step	Key operation	Screen display and notices
1	Move the cursor to PROG and press the ENTER key.	 <p>The FUNCTION indicator turns to the RCF display.</p> <p>RCF (Upper line). Displays the actual RCF computed for the motor speed and selected rotor.</p> <p>(Lower line) Set RCF Displays the set RCF computed for the motor speed and selected rotor.</p>
2	Enter the desired RCF with the ten-key numeric pad and press the ENTER key.	 <p>The RPM is computed from the set RCF and selected rotor is displayed.</p> <p>Set RCF</p>

**Note**

1. Press ESC key to clear the RCF screen.
2. The RCF operation is canceled by changing the set speed or changing the operation mode to the programmed operation mode.



## Displaying and Setting $\omega^2T$

This machine is provided with a function to perform an integrator ( $\omega^2T$ ) operation. To perform an  $\omega^2T$  operation, set the  $\omega^2T$  value instead of the run time.

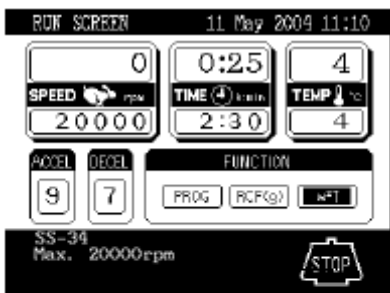
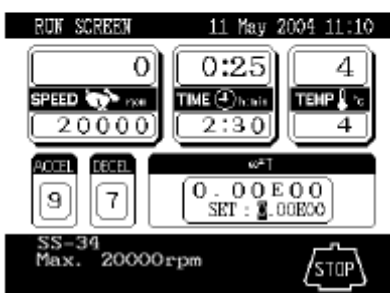
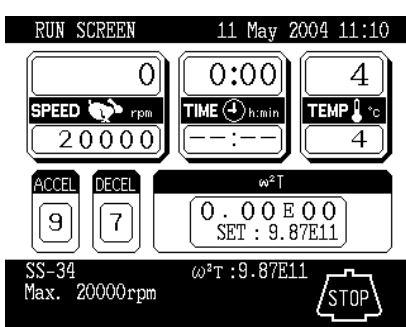
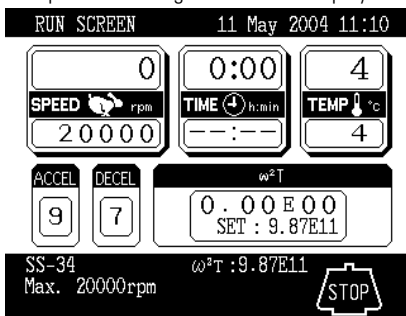
Step	Key operation	Screen display and notices
1	Set the speed in the Run Screen.	See Basic Operation.
2	<ol style="list-style-type: none"> <li>Use cursor keys to move cursor to <math>\omega^2T</math> on the RUN SCREEN.</li> <li>Press the ENTER key.</li> </ol>	<p>The FUNCTION indicator turns to the <math>\omega^2T</math> set screen.</p>  
3	<p>Enter a desired <math>\omega^2T</math> value. Example: 9.87E11</p>	<p>Entered value is displayed on the <math>\omega^2T</math> SET column and the message indicator respectively. The TIME display shows "--:--".</p>  <p>Set <math>\omega^2T</math></p>
4	<p>When you press START key, the run is controlled by the set <math>\omega^2T</math> value rather than by time.</p>	<p>Computed and integrated value is displayed on the <math>\omega^2T</math> indicator.</p> 

## 4 OPERATION

### Emergency Recovery from Power Failure

**Note** When the displayed  $\omega^2T$  reaches the set value of  $\omega^2T$ , the machine decelerates and stops. During deceleration,  $\omega^2T$  is integrated and its result is displayed until a stop.

$\omega^2T$  is selectable between 0.01E03 and 9.99E17.

The  $\omega^2T$  operation is canceled by changing the set time or changing the operation mode to the programmed operation mode. When the FUNCTION indicator shows the  $\omega^2T$  mode, the  $\omega^2T$  mode is canceled and no value is indicated on the  $\omega^2T$  SET column by changing the set time.

The  $\omega^2T$  indicator shows the current  $\omega^2T$  value computed during operation.

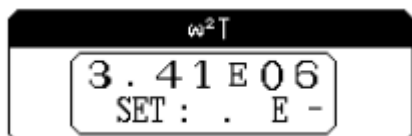

**Note** When performing the RTC operation and the  $\omega^2T$  operation in combination, following phenomenon may occur due to a conversion error from the set  $\omega^2T$  to the run time. (There is no error in operation for the set  $\omega^2T$ .)

RTC Setting	Phenomenon
When setting the operation start time	Actual operation does not start at the displayed time exactly.
When setting the operation end time	Actual operation does not end at the displayed time exactly.

## Emergency Recovery from Power Failure



**WARNING** When servicing the centrifuge, be sure to turn off the POWER switch, turn off the distribution board of your centrifuge room, and then wait for at least three minutes before removing covers or tables from the centrifuge to avoid electrical shock hazards.

### Rotation of Rotor

The rotating rotor coasts free and finally stops if a power failure occurs during operation. When the power is restored, the centrifuge automatically re-accelerates the rotor if the rotor is still rotating at 250 rpm or higher, or decelerates the rotor if the rotor is rotating under 250 rpm.

### Operation Panel



**WARNING** Never attempt to open the door while the rotor is rotating. Never attempt to slow or stop the rotor by hand.

During the power failure, all the displays on the display panel are off. When the power is restored, the centrifuge will restart the control of the run with the set parameters that were in effect before the power failure (battery-backed), and will report the occurrence of the power failure by lighting up the alarm message.

## Removing the Rotor During Power Failure



**WARNING** Never attempt to open the door while the rotor is rotating. Never attempt to slow or stop the rotor by hand.



**CAUTION** Do not perform any operation not specified in this manual. If any problem is found with your centrifuge, contact Thermo Fisher Scientific or your local representative of Thermo Fisher Scientific products.

If the power failure continues for an extended time, and you have decided to remove the rotor from the rotor chamber during the power failure, use the following procedure.

The rotor needs more than 90 minutes to coast to a complete stop if the rotor has been rotating at high speed.

1. Check that the rotor stops completely.
2. Turn off the POWER switch of the centrifuge and the distribution board of your centrifuge room.
3. Remove the two screws from the lower portion of the front cover. Remove the front cover by pulling the lower portion of the front cover forward and downward. The upper portion of the front cover is not secured with screws.
4. Raise the weights of the two door locks at the front and secure them with adhesive tape.

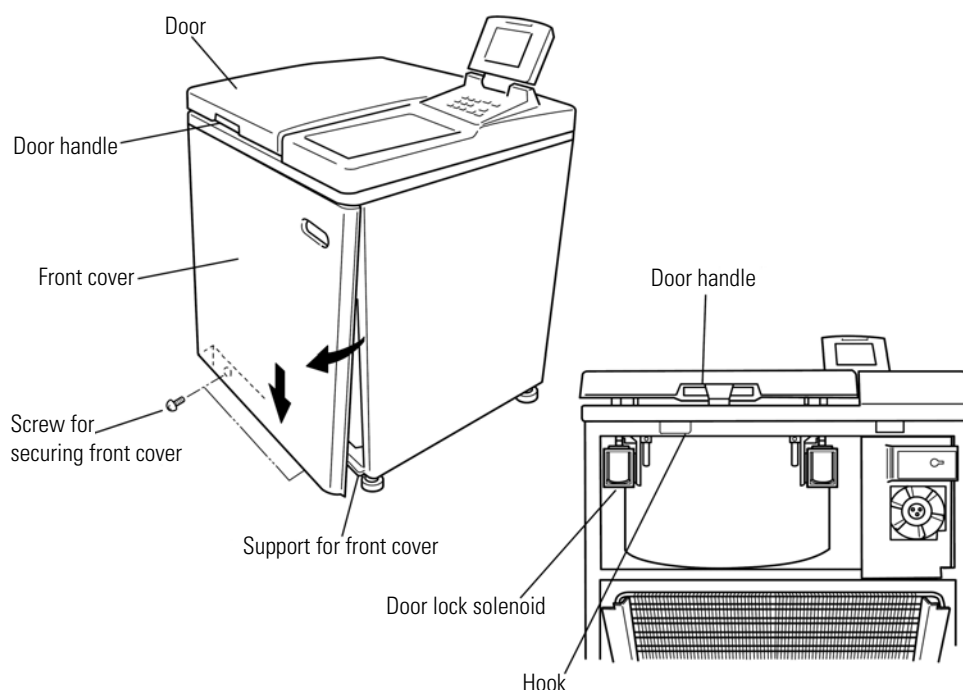

**Figure 4-9.** Opening the Door

5. Release the door handle and open the door slowly.

Check that the rotor has stopped completely. If the rotor is rotating, close the door immediately.

## 4 OPERATION

### Features on Menu Screen



**WARNING** Never attempt to slow or stop the rotor by hand.

6. Take out the rotor and remove the adhesive tape from the door lock solenoids.

Insert the hooks into the square holes and put the front cover on the support, then secure the front cover with the screws in the reverse order of removal.

## Features on Menu Screen

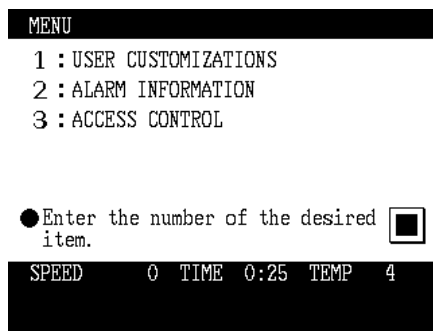

Press the MENU key and a menu appears as follows.

- (1) User customization
- (2) Alarm information
- (3) Access control

Select the desired item with the numeric key and press the ENTER key to show the corresponding screen.

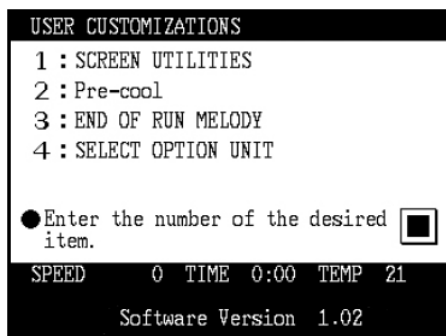

### User Customization

The user customizations include the following items.

- (1) Screen utilities
- (2) Precool
- (3) Melody

Select the desired item with the numeric key and press the ENTER key to show the corresponding screen.

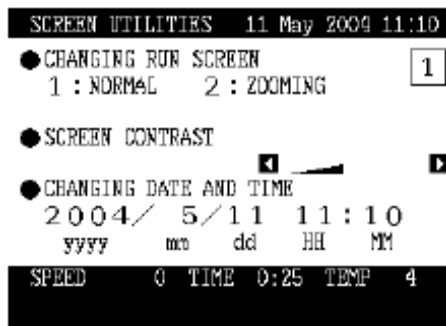

### Screen Utilities

You can customize the unit's time setting, screen contrast level, and run screen.

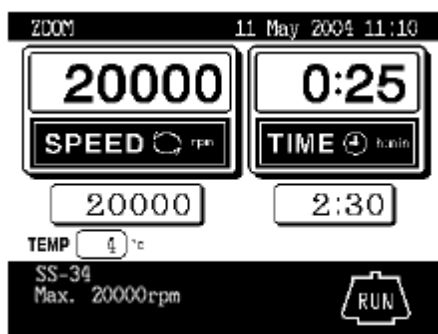

#### Changing RUN SCREEN

- 1 = NORMAL RUN SCREEN is displayed.
- 2 = ZOOM: The display automatically turns to ZOOM screen when 20 seconds have passed after reaching the set speed. The ZOOM screen returns to the RUN SCREEN by pressing any key on the panel or when the rotor starts deceleration.

#### Changing Date and Time

This feature is used when adjusting the incorporated time clock to the current date and time correctly.  
Set the correct date and time for RTC Operation.  
Enter the desired date and time using the cursor keys and the ten-key numerical pad, then press the ENTER key.

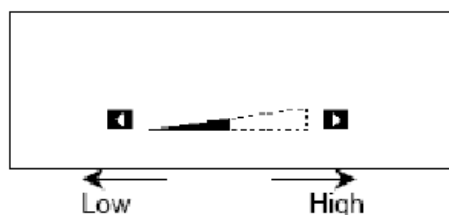

#### Screen Contrast

Use cursor keys to adjust the contrast.  
Enter the desired date and time using the cursor keys and the ten-key numerical pad, then press the ENTER key.

**Note** Press the ESC key return to the RUN SCREEN. The cursor disappears from the screen after the keyboard is idle for more than 30 seconds. Press a cursor key to show the cursor on the screen.



#### Precool

The temperature in the chamber is controlled at about 15 degrees centigrade if the door is closed and Precool is selected. (The temperature in the chamber may not hold at 15 degrees centigrade if the ambient temperature or the temperature of the evaporator is 15 degrees centigrade or less.)



#### Melody

You can select a desired melody from one tune, a beep, or beep off (silence) with the numeric key. Press the ENTER key after selection.

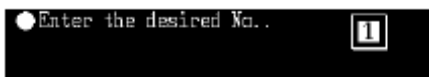

## 4 OPERATION

### Access Control

#### ● POWER

A power outage or drop occurred while the rotor was rotating. If the instrument was automatically restores and rotor rotation continues at set speed, then allow the run to continue. But if set run time elapses, restart the run.

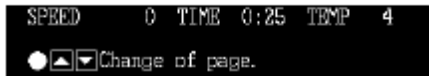

SPEED 0 TIME 0:25 TEMP 4  
●▲▼ Change of page.

### Alarm Information

Alarm information and remedies are displayed on the ALARM INFORMATION screen.

This feature allows you to cope with troubles that occurred during operation. Refer to *Troubleshooting* for details.

## Access Control

Access control is specifically designed for use with the RC6+ centrifuge. This feature is used to limit use of the centrifuge to registered users, as determined by the centrifuge administrator.

Prior to using the Access Control feature, the centrifuge administrator is advised to read the separate manual "RC6+ Access Control Instruction Manual" (PN 50106183)

## CARE AND MAINTENANCE

This section describes routine maintenance activities to ensure your centrifuge remains in good operating condition. We also recommend that you have the centrifuge serviced at least once a year, more frequently if you use it heavily. Contact Thermo Fisher Scientific or your local representative of Thermo Fisher Scientific products.

### Contents

- “Rotor Chamber” on page 5-3
- “Tapered Drive Shaft (Drive Spindle)” on page 5-3
- “Cabinet” on page 5-4
- “Rotor” on page 5-4
- “Condenser Fins” on page 5-4
- “Replacement Parts” on page 5-4
- “Service Decontamination Policy” on page 5-4

Be sure to read and keep in mind the following cautionary information before maintenance.



**DANGER** When servicing the centrifuge, be sure to turn off the POWER switch, turn off the distribution board of your centrifuge room, and then wait for at least three minutes before removing covers or tables from the centrifuge to avoid electrical shock hazards



**WARNING** Be sure to take necessary safety measures before using materials that are toxic, radioactive, or contaminated with pathogenic micro-organisms. If the instrument, the rotor, and/or accessories has been used with toxic, radioactive, or pathogenic materials, clean it by following the Service Decontamination Policy. There are no user-serviceable items inside the centrifuge. Due to the hazards involved, repair should only be attempted by a qualified technician who is familiar with electronics and trained in the servicing of the centrifuge.



**CAUTION** Do not operate the instrument in any way other than specified in this manual. If you encounter any problem with the instrument, call an authorized Thermo Fisher Scientific Representative. Chlorides (for example, bleach solutions) are extremely harmful to aluminum alloys and can cause stress corrosion cracking. Therefore, do not use chlorides to decontaminate the chamber. Use only cleaning and decontamination methods mentioned in this installation manual or in the Thermo Fisher Scientific Product Guide. Cleaners other than those specified may be harmful to the centrifuge chamber. Before using any cleaning or decontamination method except those recommended by these operating instructions, you should check with an authorized Thermo Fisher Scientific Representative that the proposed method will not damage this centrifuge.

Maintenance Activity	Frequency
Clean the rotor chamber	Daily or immediately after a spill
Wash the tapered spindle	Once a week.
Clean the cabinet panels	Once a month.
Clean the condenser fins	Once every 6 months.
Have centrifuge ground continuity tested.*	Once a year when the centrifuge is serviced.
Clean the inlet on the drive box (wipe with cloth)	Once a month.

\*Ground Continuity test

To ensure that your centrifuge is in safe working order, we recommend that you have the ground continuity tested at least once a year. Because special equipment is required for this test, it should be performed by Thermo Fisher Scientific or your local representative of Thermo Fisher Scientific products as part of routine servicing.

For information on the maintenance of rotors and tubes, see the rotor instruction manual.



## Rotor Chamber

Defrost and clean the rotor chamber periodically to maintain efficient cooling.



**CAUTION** Do not pour any solution such as water, detergent or disinfectant directly into the rotor chamber. Otherwise, the bearings of the drive unit may become corroded or deteriorate.

To defrost the chamber:

1. Install a rotor and close the chamber door.
2. Set the RUN temperature switch for 25 degrees C.
3. Run the centrifuge until the frost melts.
4. When defrosting is complete, wipe the chamber dry with a damp sponge or cloth.

**Note** To prevent condensation from forming in the rotor chamber, keep the chamber door closed when the chamber is cold.

When cleaning the rotor chamber, use the appropriate solution followed by several deionized water rinses:

### Routine Cleaning

Wash the rotor chamber with a mild non-alkaline dishwashing liquid, then rinse and dry with a soft absorbent cloth.

### Disinfection

70% ethanol (also use for the rubber door seal).

### General Radioactive Decontamination

A solution of equal parts 70% ethanol, 10% SDS, and water, followed by ethanol rinses, then deionized water. Dry with a soft absorbent cloth. Dispose of all wash solutions in proper radioactive waste containers.

## Tapered Drive Shaft (*Drive Spindle*)



**CAUTION** Clean the inside of the centrifuge drive spindle hole the surface of the drive spindle once a month. If the drive hole or the drive shaft is stained or any foreign matter is adhered, the rotor may be improperly installed and come off during operation.

This part is very important because the rotor is mounted on and is driven by the drive spindle. To minimize the chance of rotor sticking, wipe the outer surface of the drive spindle with a soft cloth dampened with water sufficiently each time a rotor is to be installed.

## Cabinet

Always keep the table and the cabinet of the centrifuge clean, to prevent dust and other materials from falling into the rotor chamber. Clean the table, cabinet panels, top deck, and chamber door with a mild, non-alkaline detergent and water. Do not use abrasive cleansers. If any solution or hazardous materials that are toxic, radioactive, or pathogenic are spilled inside or outside the centrifuge, take the necessary action according to your proper laboratory procedures and methods.

## Rotor

To prevent corrosion, remove the rotor from the rotor chamber after operation and remove the rotor cover to dry the tube cavities.

If any sample is spilled inside the rotor, wash and dry the rotor well, then apply lubricant/grease specified in the rotor manual.

Regularly apply lubricant grease to the thread portion of the rotor cover knob.

## Condenser Fins



**CAUTION** Avoid contacting the condenser fins that can cause injury to fingers.

To maintain the efficiency of the refrigeration system, remove the front cover and clean the radiator with a vacuum cleaner at sixmonth intervals.

## Replacement Parts

To order replacement parts, contact Thermo Fisher Scientific or your local representative of Thermo Fisher Scientific products. Be sure to provide the part number, the part name, and the quantity of parts you need, as well as the model and serial number of the Superspeed centrifuge you are using.

## Service Decontamination Policy



**WARNING** Because of the characteristics of the samples likely to be processed, biological or radioactive contamination may occur. Always be aware of this possibility and take adequate precaution. Use appropriate decontamination procedures should exposure occur.

If a centrifuge or rotor that has been used with radioactive or pathogenic material requires servicing by Thermo Fisher Scientific personal, either at the customer's laboratory or at a Thermo Fisher Scientific facility, comply with the following procedure to ensure the safety of all personnel:

1. Clean the centrifuge to be serviced of all encrusted material and decontaminate it (for rotors: see the Care and Maintenance section of the rotor instruction manual) prior to servicing by the Thermo Fisher Scientific representative or returning it to the Thermo Fisher Scientific facility.

There must be no radioactivity detectable by survey equipment. The Thermo Fisher Scientific Product Guide contains descriptions of commonly used decontamination methods and a chart showing method compatibility with various materials.

Clean and decontaminate your centrifuge as follows:

For Superspeed floor model centrifuges:

- a. Remove rotor from the rotor chamber.
- b. Decontaminate door and rotor chamber using an appropriate method.
- c. Decontaminate lid, rotor chamber, and drive using an appropriate method.
- d. Remove all encrusted material from around the motor and drive assemblies.

For rotors:

Remove tubes, bottles, and adapters from the rotor and decontaminate rotor using an appropriate method. If tubes or rotor caps are stuck in the rotor, or the rotor lid is stuck, notify your Thermo Fisher Scientific representative; be prepared with the name and nature of the sample so the official Thermo Fisher Scientific representative can decide whether to authorize the rotor's return to a Thermo Fisher Scientific facility.

Do not leave a loaded rotor locked inside a centrifuge that requires servicing. If, with a loaded rotor installed in the chamber, a centrifuge malfunction makes it so that the chamber door will not open by normal means, follow the Emergency Recovery from Power Failure found in your centrifuge operating instructions manual to gain access to the rotor.

2. Complete and attach Decontamination Information Certificates (in the back of your rotor or instrument manual) to the centrifuge or rotor before servicing.

Decontamination Information Certificates are included with these instructions. Additional certificates are available from the local Thermo Fisher Scientific Representative or Thermo Fisher Scientific. In the event these certificates are not available, a signed, written statement certifying that the unit has been properly decontaminated, identifying what the contaminants were and outlining the decontamination procedures used will be acceptable.

**Note** The authorized Thermo Fisher Scientific representative will note on the Customer Service Repair Report if decontamination was required and, if so, what the contaminant was and what procedure was used. If no decontamination was required, it will be so stated.

If a centrifuge or rotor to be serviced does not have a Decontamination Information Certificate attached and, in Thermo Fisher Scientific's opinion presents a potential radioactive or biological hazard, the Thermo Fisher Scientific representative will not service the equipment until proper decontamination and certification is complete.



**CAUTION** Do not ship or transport a centrifuge with a rotor installed on the drive spindle. If a centrifuge chamber door cannot be opened using conventional methods, refer to the Emergency Recovery from Power Failure (mechanical override) instructions that are provided with this centrifuge.

If the centrifuge or rotor must be returned to a Thermo Fisher Scientific facility:

1. Contact your Thermo Fisher Scientific representative to obtain an Equipment Return Decontamination Form; be prepared with the name and serial number of the centrifuge or rotor and the repairs required.
2. Complete the Equipment Return Decontamination Form and return it to Thermo Fisher Scientific. Upon receipt of a complete form, a Returned Material Authorization Number (RMA Number) will be issued to you.
3. With the RMA Number clearly marked on the outside of packaging, send the items to the address obtained from your Thermo Fisher Scientific representative.

**Note** United States federal regulations require that parts and instruments must be decontaminated before being transported. Outside the United States, check local regulations.

If equipment is received at Thermo Fisher Scientific facilities without a valid RMA Number on the outside of the shipping container and a completed Equipment Return Decontamination Form on file, the equipment will be treated as a potential contamination hazard, and will not be serviced until decontamination certification has been completed. The sender will be contacted for instructions regarding disposition of the equipment in question; all disposition costs will be borne by the sender. If contaminated equipment is received at Thermo Fisher Scientific facilities, both carrier and appropriate authorities shall be notified.

# TROUBLESHOOTING

The RC6 Plus Superspeed centrifuge has a self-diagnosis capability that identifies and reports a problem that occurs when the instrument is starting up or in operation, and that affects the operation of the instrument.

## Contents



- [“Alarm Messages”](#) on page 6-2

# Alarm Messages

When a problem occurs that affects instrument operation, the centrifuge beeps and displays an alarm message, in order to report the occurrence of the problem.

The RC6 Plus Superspeed centrifuge shows an alarm information screen to help the user to identify problem immediately. You can call up the alarm information screen according to the following procedure (example).

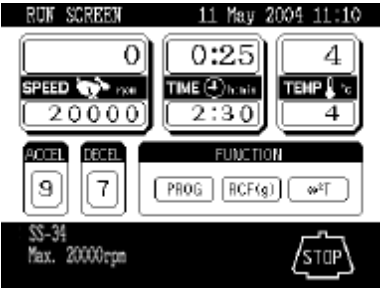
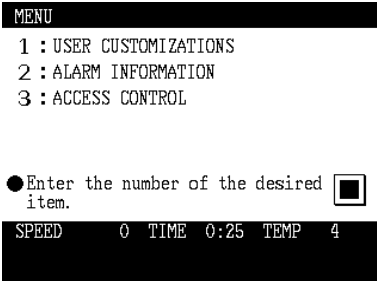
**Table 6-1.** Displaying Alarm Information

Step	Key operation	Screen display and notices
1	The alarm message "SPEED" is displayed.	 <p>The alarm message appears on the message indicator of the RUN SCREEN.</p>
2	Press the MENU key.	 <p>Enter the number of the desired item.</p> <p>The screen turns to the MENU screen.</p>
3	Select "ALARM INFORMATION" by pressing the following keys.	 <p>ALARM INFORMATION screen appears. Corresponding alarm information is displayed. * Press the ESC key two times to return to the RUN SCREEN.</p>

### Corrective Actions

In response to the displayed alarm message, take the appropriate actions as described below to identify the cause of the problem, then press the CE key to clear the alarm.

If after performing the corrective actions, the problem still persists, contact Thermo Fisher Scientific or your local representative of Thermo Fisher Scientific products to ask for repair.

Alarm message	Cause	Corrective action
POWER	A power failure occurred while the rotor was spinning and the speed decreased more than or equal to 300 rpm from the set speed.  If the rotor is rotating at 250 rpm or more when the power is restored, the centrifuge will accelerate again or decelerate if the speed is less than 250 rpm.	Check the run time if the rotor has stopped and restart operation if necessary.
ROTOR	Rotor is not properly secured to the drive spindle.	Make sure the rotor is secured to the drive spindle.
ROTOR No.	The selected rotor does not correspond to the installed rotor.	Confirm the chosen rotor number matches the installed rotor.
TEMP	TEMP display shows a temperature over 50 degrees centigrade or a temperature lower or higher than the set temperature more than 20 degrees centigrade.	Lower the room temperature if it is over 35 degrees centigrade. Clean the condenser fins.
DOOR OPEN	START key is pressed with the door opened, or the door handle is released while the rotor is rotating.	Close the door and start operation. If the door handle is released, lock it again immediately to clear the alarm and reaccelerate the rotor.
SPEED	Rotor speed is set higher than the maximum allowable speed.	Set the speed within the permitted limits.
IMBALANCE	Rotor is not properly balanced.	Check if the sample tubes exceed allowable imbalance level.
	Rotor locking knob is not properly tightened.	Tighten the rotor locking knob properly and start operation.
E10 to E95	Rotor cover is not properly secured with the screw.	Secure the rotor cover properly.
	The centrifuge has a problem requiring maintenance by Thermo Service.	Contact Thermo Fisher Scientific or your local representative of Thermo Fisher Scientific products.

If any of the alarm messages E10 to E95 lights up, it is indicating that the centrifuge has a problem and requires maintenance by a Thermo Service Representative. When you call the service personnel, inform them of the displayed alarm code.

**Note** The E13 alarm code indicates that the speed sensor is malfunctioning. When this alarm code appears, the centrifuge will not accept the CE key input for 90 minutes until the rotor stops completely for safety. Wait without turning off the power to the centrifuge. After 90 minutes or more, press the CE key.

**User Corrected Problems**

Some problems are not identified and reported by the self-diagnostic capability of the centrifuge.

To correct these problems, take the actions described in the table below.

Symptom	Cause	Corrective Action
Centrifuge does not accept entries of run conditions.	ENTER key is not pressed after entering the numeric values.	Press the ENTER key after entering run conditions.
Rotor does not start accelerating when START key is pressed.	The beeper sounds three short beeps when the START key is pressed because invalid run conditions are entered.	Verify the run conditions.
Run conditions cannot be set or recalled.	The rotor is still rotating.	Set or recall the run conditions when the rotor stops completely.
Recalled run conditions are changed.	The battery to back up the program memory is dead.	Set the run conditions again and keep the centrifuge turned on for 10 hours to recharge the battery.
Rotor is not cooled.	The ambient temperature is too high.	Lower the room temperature using an air conditioner or lower the speed in non-air-conditioned environments.
	A heat-producing device such as a refrigerator or a generator is near the centrifuge.	Relocate the heat-producing device to another place or contact Thermo Fisher Scientific or your local representative of Thermo Fisher Scientific products to ask for relocation of the centrifuge.
	The condenser fins are clogged with dust.	Clean the condenser fins according to the procedure specified on page 5-3.



## Rotor Information Table



**CAUTION** Read the rotor instruction manual thoroughly before use. Mount the rotor cover securely. Be sure to tighten the rotor locking knob after mounting the rotor on the drive spindle.

**Table A-1.** Rotor Information Table

Rotor	Code #	Max, Speed (rpm)	Max, RCF	K Factor *	Max, Compartment Mass (g)	Radius Max. (cm)	Radius Min. (cm)
SA-600	04	16,500	39,412	793	115	12.96	5.52
SS-34	05	20,000	47,808	750	115	10.70	3.27
SE-12	06	22,000	50,441	468	30	9.33	3.81
HS-4	08	7,500	10,826	3,912	1,035	17.23	7.22
SM-24	09	20,000	49,461 **	456	27	11.07	5.38
SH-MT	12	13,700	19,057	657	36,4	9.09	5.57
SH-80	13	20,000	45,395	400	78	10.16	5.40
HB-6	23	13,000	27,617	1,765	164	14.63	4.50
F-20/MICRO	25	20,000	51,427	187	3,0	11.51	8.57
SA-300	26	22,000	52,279	739	115	9.67	2.35
SLA-1000	27	16,500	35,793	1,725	400	11.77	1.84
SLA-1500	28	14,500	31,916	1,579	420	13.59	3.66
SH-3000 (buckets)	29	4,700	4,575	8,138	1,805	18.54	9.11
SLA-3000	30	11,000	20,449	2,813	780	15.13	3.94
SH-3000 (micro plates)	31	4,700	3,706	----- ***	987	15.02	-----
SLA-600TC	32	13,000	27,750	913	74	14.70	7.99
SLC-4000	33	8,000	11,996	7,448	1,500	16.78	2.55
SLC-1500	34	14,000	29,994	1,676	420	13.70	3.74
SLC-3000	35	10,000	17,604	3,394	780	15.76	4.12
SA-512	36	18,500	44,040	438	30	11.52	6.37
SA-800	37	19,500	44,385	619	162	10.45	4.12
SA-400TC	38	18,000	42,162	424	70	11.65	6.80
SA-650TC	39	15,000	32,270 32,421	482 903	50TC: 67 15TC: 25	12.84 12.90	8.40 5.78

**Table A-1.** Rotor Information Table

<b>Rotor</b>	<b>Code #</b>	<b>Max, Speed (rpm)</b>	<b>Max, RCF</b>	<b>K Factor *</b>	<b>Max, Compartment Mass (g)</b>	<b>Radius Max. (cm)</b>	<b>Radius Min. (cm)</b>
F-28/50	40	19,000	46,251	731	90	11.47	4.04
F21S-8x50Y	41	20,000	47,361	739	115	10.6	3.3
F13S-14x50CY	42	13,000	28,882	917	75	15.3	8.3
SS-34/KSB	43	20,000	47,808	----	----	10.70	----
TZ-28/GK ****	44	19,000	38,428	----	----	9.53	----
F-22/MICRO	45	22,000	55,144	190	3,8	10.20	7.10
F9S-4X1000Y	46	8,000	11,996	7,457	1,500	16.78	2.55
F10S-6x500Y	47	10,000	17,604	3,398	765	15.76	4.12
F14S-6X250Y	48	14,000	29,994	1,692	420	13.70	3.70
F10S-4x1000 LEX	55	9,500	16,880	5,330	1,400	16.70	2.50
F12S-6x500 LEX	54	12,000	24,515	2,263	675	15.20	4.20
F21S-8x50	49	18,000	38,362	912	115	10.60	3.30
F14S-6X250	50	14,000	29,994	1,692	420	13.70	3.70
F18S-12x50	51	16,500	38,621	808	75	12.70	5.33
F21S-48x1.5	52	20,000	43,223	242	3,2	9.45	6.45
F20S-6x100	53	20,000	43,474	791	132	9.73	2.79

\* With maximum allowable volume at maximum speed,

\*\* Outer row,

\*\*\* Will vary depending on number and size of microplate,

\*\*\*\* Compatible to RC-6Plus hence 2006 (EQ 40548478 and all consecutive). Rework service for rotors manufactured before 2006: PN 46945.

# Chemical Compatibility Chart

CHEMICAL	MATERIAL	ALUMINUM	ANODIC COATING for ALUMINIUM	BUNA N	CELLULOSE ACETATE BUTYRATE	POLYURETHANE ROTOR PAINT	COMPOSITE Carbon Fiber/Epoxy	DELRIIN	ETHYLENE PROPYLENE	GLASS	NEOPRENE	NORYL	NYLON	PET <sup>1</sup> , POLYCLEAR, CLEARCRIMP	POLYALLOMER	POLYCARBONATE	POLYESTER, GLASS THERMOSET	POLYETHERIMIDE	POLYRTHYLENE	POLYPROPYLENE	POLYSULFONE	POLYVINYL CHLORIDE	RULON A, TEFLON	SILICONE RUBBER	STAINLESS STEEL	TITANIUM	TYGON	VITON
2-mercaptoethanol	S	S	U	-	S	M	S	-	S	U	S	S	U	S	S	-	S	S	S	S	U	S	S	S	S	S	S	S
Acetaldehyde	S	-	U	U	-	-	-	M	-	U	-	-	-	M	U	U	U	M	M	-	M	S	U	-	S	-	U	
Acetone	M	S	U	U	S	U	M	S	S	U	U	S	U	S	U	U	U	S	S	U	U	S	M	M	S	U	U	
Acetonitrile	S	S	U	-	S	M	S	-	S	S	U	S	U	M	U	U	-	S	M	U	U	S	S	S	S	U	U	
Alconox	U	U	S	-	S	S	S	-	S	S	S	S	S	S	M	S	S	S	S	S	S	S	S	S	S	S	S	U
Allyl Alcohol	-	-	-	U	-	-	S	-	-	-	-	S	-	S	S	M	S	S	S	-	M	S	-	-	S	-	-	
Aluminum Chloride	U	U	S	S	S	S	U	S	S	S	S	S	M	S	S	S	S	-	S	S	S	S	S	M	U	U	S	S
Formic Acid (100%)	-	S	M	U	-	-	U	-	-	-	-	U	-	S	M	U	U	S	S	-	U	S	-	U	S	-	U	
Ammonium Acetate	S	S	U	-	S	S	S	-	S	S	S	S	S	S	S	U	-	S	S	S	S	S	S	S	S	S	S	S
Ammonium Carbonate	M	S	U	S	S	S	S	S	S	S	S	S	S	S	U	U	-	S	S	S	S	S	S	M	S	S	S	S
Ammonium Hydroxide (10%)	U	U	S	U	S	S	M	S	S	S	S	S	-	S	U	M	S	S	S	S	S	S	S	S	S	S	M	S
Ammoniumhydroxid (28%)	U	U	S	U	S	U	M	S	S	S	S	S	U	S	U	M	S	S	S	S	S	S	S	S	S	S	M	S
Ammonium Hydroxide (conc.)	U	U	U	U	S	U	M	S	-	S	-	S	U	S	U	U	S	S	S	-	M	S	S	S	S	-	U	
Ammonium Phosphate	U	-	S	-	S	S	S	S	S	S	S	S	-	S	S	M	-	S	S	S	S	S	S	M	S	S	S	S
Ammonium Sulfate	U	M	S	-	S	S	U	S	S	S	S	S	S	S	S	S	-	S	S	S	S	S	S	U	S	S	U	
Amyl Alcohol	S	-	M	U	-	-	S	S	-	M	-	S	-	M	S	S	S	S	M	-	-	-	U	-	S	-	M	
Aniline	S	S	U	U	S	U	S	M	S	U	U	U	U	U	U	U	-	S	M	U	U	S	S	S	S	U	S	
Sodium Hydroxide (<1%)	U	-	M	S	S	S	-	-	S	M	S	S	-	S	M	M	S	S	S	S	S	S	M	S	S	-	U	
Sodium Hydroxide (10%)	U	-	M	U	-	-	U	-	M	M	S	S	U	S	U	U	S	S	S	S	S	S	M	S	S	-	U	
Barium Salts	M	U	S	-	S	S	S	S	S	S	S	S	S	S	S	M	-	S	S	S	S	S	M	S	S	S	S	S
Benzene	S	S	U	U	S	U	M	U	S	U	U	S	U	U	U	M	U	M	U	U	U	U	U	U	U	S	U	S
Benzyl Alcohol	S	-	U	U	-	-	M	M	-	M	-	S	U	U	U	U	U	U	-	M	S	M	-	S	-	S	S	
Boric Acid	U	S	S	M	S	S	U	S	S	S	S	S	S	S	S	S	U	S	S	S	S	S	S	S	S	S	S	S
Cesium Acetate	M	-	S	-	S	S	S	-	S	S	S	S	-	S	S	-	-	S	S	S	S	S	S	M	S	S	S	S
Cesium Bromide	M	S	S	-	S	S	S	-	S	S	S	S	S	S	S	-	-	S	S	S	S	S	S	M	S	S	S	S

# A Chemical Compatibility Chart

CHEMICAL	MATERIAL																											
	ALUMINUM	ANODIC COATING for ALUMINUM	BUNA N	CELLULOSE ACETATE BUTYRATE	POLYURETHANE ROTOR PAINT	COMPOSITE Carbon Fiber/Epoxy	DELRIN	ETHYLENE PROPYLENE	GLASS	NEOPRENE	NORYL	NYLON	PET <sup>1</sup> , POLYCLEAR, CLEARCRIMP	POLYALLOMER	POLYCARBONATE	POLYESTER, GLASS THERMOSET	POLYETHERIMIDE	POLYRTHYLENE	POLYPROPYLENE	POLYSULFONE	POLYVINYL CHLORIDE	RULON A, TEFLON	SILICONE RUBBER	STAINLESS STEEL	TITANIUM	TYGON	VITON	
Cesium Chloride	M	S	S	U	S	S	S	-	S	S	S	S	S	S	S	-	-	S	S	S	S	S	S	M	S	S	S	
Cesium Formate	M	S	S	-	S	S	S	-	S	S	S	S	S	S	S	-	-	S	S	S	S	S	S	M	S	S	S	
Cesium Iodide	M	S	S	-	S	S	S	-	S	S	S	S	S	S	S	-	-	S	S	S	S	S	S	M	S	S	S	
Cesium Sulfate	M	S	S	-	S	S	S	-	S	S	S	S	S	S	S	-	-	S	S	S	S	S	S	M	S	S	S	
Chloroform	U	U	U	U	S	S	M	U	S	U	U	M	U	M	U	U	U	M	M	U	U	S	U	U	U	M	S	
Chromic Acid (10%)	U	-	U	U	S	U	U	-	S	S	S	U	S	S	M	U	M	S	S	U	M	S	M	U	S	S	S	
Chromic Acid (50%)	U	-	U	U	-	U	U	-	-	-	S	U	U	S	M	U	M	S	S	U	M	S	-	U	M	-	S	
Cresol Mixture	S	S	U	-	-	-	S	-	S	U	U	U	U	U	U	-	-	U	U	-	U	S	S	S	S	U	S	
Cyclohexane	S	S	S	-	S	S	S	U	S	U	S	S	U	U	U	M	S	M	U	M	M	S	U	M	M	U	S	
Deoxycholate	S	S	S	-	S	S	S	-	S	S	S	S	S	S	S	-	-	S	S	S	S	S	S	S	S	S	S	
Distilled Water	S	S	S	S	S	S	S	S	S	S	S	S	S	S	S	S	S	S	S	S	S	S	S	S	S	S	S	
Dextran	M	S	S	S	S	S	S	-	S	S	S	S	S	S	S	S	S	S	S	S	S	S	S	M	S	S	S	
Diethyl Ether	S	S	U	U	S	S	S	U	S	U	U	S	U	U	U	U	U	U	U	U	U	S	S	S	S	M	U	
Diethyl Ketone	S	-	U	U	-	-	M	-	S	U	-	S	-	M	U	U	U	M	M	-	U	S	-	-	S	U	U	
Diethylpyrocarbonate	S	S	U	-	S	S	S	-	S	S	U	S	U	S	U	-	-	S	S	S	M	S	S	S	S	S	S	
Dimethylsulfoxide	S	S	U	U	S	S	S	-	S	U	S	S	U	S	U	U	-	S	S	U	U	S	S	S	U	U	U	
Dioxane	M	S	U	U	S	S	M	M	S	U	U	S	U	M	U	U	-	M	M	M	U	S	S	S	S	U	U	
Ferric Chloride	U	U	S	-	-	-	M	S	-	M	-	S	-	S	-	-	-	S	S	-	-	-	M	U	S	-	S	
Acetic Acid (Glacial)	S	S	U	U	S	S	U	M	S	U	S	U	U	U	U	U	M	S	U	M	U	S	U	U	S	-	U	
Acetic Acid (5%)	S	S	M	S	S	S	M	S	S	S	S	S	M	S	S	S	S	S	S	S	M	S	S	M	S	S	M	
Acetic Acid (60%)	S	S	U	U	S	S	U	-	S	M	S	U	U	M	U	S	M	S	M	S	M	S	M	U	S	M	U	
Ethyl Acetate	M	M	U	U	S	S	M	M	S	S	U	S	U	M	U	U	-	S	S	U	U	S	M	M	S	U	U	
Ethyl Alcohol (50%)	S	S	S	S	S	S	M	S	S	S	S	S	U	S	U	S	S	S	S	S	S	S	S	M	S	M	U	
Ethyl Alcohol (95%)	S	S	S	U	S	S	M	S	S	S	S	S	U	S	U	-	S	S	S	M	S	S	S	U	S	M	U	
Ethylene Dichloride	S	-	U	U	-	-	S	M	-	U	U	S	U	U	U	U	U	U	U	-	U	S	U	-	S	-	S	
Ethylene Glycol	S	S	S	S	S	S	S	S	S	S	S	S	-	S	U	S	S	S	S	S	S	S	S	M	S	M	S	
Ethylene Oxide Vapor	S	-	U	-	-	U	-	-	S	U	-	S	-	S	M	-	-	S	S	S	U	S	U	S	S	S	U	
Ficoll-Hypaque	M	S	S	-	S	S	S	-	S	S	S	S	-	S	S	-	S	S	S	S	S	S	S	M	S	S	S	
Hydrofluoric Acid (10%)	U	U	U	M	-	-	U	-	-	U	U	S	-	S	M	U	S	S	S	S	M	S	U	U	U	-	-	
Hydrofluoric Acid (50%)	U	U	U	U	-	-	U	-	-	U	U	U	U	S	U	U	U	S	S	M	M	S	U	U	U	-	M	
Hydrofluoric Acid (conc.)	U	U	U	U	-	U	U	M	-	U	M	U	U	M	U	U	U	-	S	-	U	S	U	U	U	-	-	
Formaldehyde (40%)	M	M	M	S	S	S	S	M	S	S	S	S	M	S	S	S	U	S	S	M	S	S	M	S	M	U	U	

CHEMICAL	MATERIAL																										
	ALUMINUM	ANODIC COATING for ALUMINUM	BUNA N	CELLULOSE ACETATE BUTYRATE	POLYURETHANE ROTOR PAINT	COMPOSITE Carbon Fiber/Epoxy	DELRIN	ETHYLENE PROPYLENE	GLASS	NEOPRENE	NORYL	NYLON	PET <sup>1</sup> , POLYCLEAR, CLEARCRIMP	POLYALLOMER	POLYCARBONATE	POLYESTER, GLASS THERMOSET	POLYETHERIMIDE	POLYRTHYLENE	POLYPROPYLENE	POLYSULFONE	POLYVINYL CHLORIDE	RULON A, TEFLON	SILICONE RUBBER	STAINLESS STEEL	TITANIUM	TYGON	VITON
Glutaraldehyde	S	S	S	S	-	-	S	-	S	S	S	S	S	S	S	-	-	S	S	S	-	-	S	S	S	-	-
Glycerol	M	S	S	-	S	S	S	S	S	S	S	S	S	S	S	S	-	S	S	S	S	S	S	S	S	S	S
Guanidine Hydrochloride	U	U	S	-	S	S	S	-	S	S	S	S	S	S	S	-	-	S	S	S	S	S	S	S	U	S	S
Haemo-Sol	S	S	S	-	-	-	S	-	S	S	S	S	S	S	S	-	-	S	S	S	S	S	S	S	S	S	S
Hexane	S	S	S	-	S	S	S	-	S	S	U	S	U	M	U	S	S	U	S	S	M	S	U	S	S	U	S
Isobutyl Alcohol	-	-	M	U	-	-	S	S	-	U	-	S	U	S	S	M	S	S	S	-	S	S	S	-	S	-	S
Isopropyl Alcohol	M	M	M	U	S	S	S	S	U	S	S	U	S	U	M	S	S	S	S	S	S	S	S	M	M	M	S
Iodoacetic Acid	S	S	M	-	S	S	S	-	S	M	S	S	M	S	S	-	M	S	S	S	S	S	M	S	S	M	M
Potassium Bromide	U	S	S	-	S	S	S	-	S	S	S	S	S	S	S	S	S	S	S	-	S	S	S	M	S	S	S
Potassium Carbonate	M	U	S	S	S	S	S	-	S	S	S	S	S	S	U	S	S	S	S	S	S	S	S	S	S	S	S
Potassium Chloride	U	S	S	-	S	S	S	S	S	S	S	S	S	S	S	-	S	S	S	S	S	S	S	U	S	S	S
Potassium Hydroxide (5%)	U	U	S	S	S	S	M	-	S	S	S	S	-	S	U	S	S	S	S	S	S	S	M	U	M	S	U
Potassium Hydroxide (conc.)	U	U	M	U	-	-	M	-	M	S	S	-	U	M	U	U	U	S	M	-	M	U	-	U	U	-	U
Potassium Permanganate	S	S	S	-	S	S	S	-	S	S	S	U	S	S	S	M	-	S	M	S	U	S	S	M	S	U	S
Calcium Chloride	M	U	S	S	S	S	S	S	S	S	S	S	S	S	M	S	-	S	S	S	S	S	S	M	S	S	S
Calcium Hypochlorite	M	-	U	-	S	M	M	S	-	M	-	S	-	S	M	S	-	S	S	S	M	S	M	U	S	-	S
Kerosene	S	S	S	-	S	S	S	U	S	M	U	S	U	M	M	S	-	M	M	M	S	S	U	S	S	U	S
Sodium Chloride (10%)	S	-	S	S	S	S	S	S	-	-	-	S	S	S	S	S	-	S	S	S	S	-	S	S	M	-	S
Iodoacetic Acid	U	-	S	U	S	S	S	-	-	-	-	S	S	S	S	S	-	S	S	-	S	-	S	S	M	-	S
Carbon Tetrachloride	U	U	M	S	S	U	M	U	S	U	U	S	U	M	U	S	S	M	M	S	M	M	M	M	U	S	S
Aqua Regia	U	-	U	U	-	-	U	-	-	-	-	-	U	U	U	U	U	U	U	-	-	-	-	-	S	-	M
Solution 555 (20%)	S	S	S	-	-	-	S	-	S	S	S	S	S	S	S	-	-	S	S	S	-	S	S	S	S	S	S
Magnesium Chloride	M	S	S	-	S	S	S	S	S	S	S	S	S	S	S	S	S	S	S	S	S	S	S	M	S	S	S
Mercaptoacetic Acid	U	S	U	-	S	M	S	-	S	M	S	U	U	U	U	-	S	U	U	S	M	S	U	S	S	S	S
Methyl Alcohol	S	S	S	U	S	S	M	S	S	S	S	S	U	S	U	M	S	S	S	S	S	S	S	M	S	M	U
Methylene Chloride	U	U	U	U	M	S	S	U	S	U	U	S	U	U	U	U	U	M	U	U	U	S	S	M	U	S	U
Methyl Ethyl Ketone	S	S	U	U	S	S	M	S	S	U	U	S	U	S	U	U	U	S	S	U	U	S	S	S	S	U	U
Metrizamide	M	S	S	-	S	S	S	-	S	S	S	S	-	S	S	-	-	S	S	S	S	S	S	M	S	S	S
Lactic Acid (100%)	-	-	S	-	-	-	-	-	-	M	S	U	-	S	S	S	M	S	S	-	M	S	M	S	S	-	S
Lactic Acid (20%)	-	-	S	S	-	-	-	-	-	M	S	M	-	S	S	S	S	S	S	S	M	S	M	S	S	-	S
N-Butyl Alcohol	S	-	S	U	-	-	S	-	-	S	M	-	U	S	M	S	S	S	S	M	M	S	M	-	S	-	S
N-Butyl Phthalate	S	S	U	-	S	S	S	-	S	U	U	S	U	U	U	M	-	U	U	S	U	S	M	M	S	U	S

# A Chemical Compatibility Chart

CHEMICAL	MATERIAL	ALUMINUM	ANODIC COATING for ALUMINUM	BUNA N	CELLULOSE ACETATE BUTYRATE	POLYURETHANE ROTOR PAINT	COMPOSITE Carbon Fiber/Epoxy	DELRIN	ETHYLENE PROPYLENE	GLASS	NEOPRENE	NORYL	NYLON	PET <sup>1</sup> , POLYCLEAR, CLEARCRIMP	POLYALLOMER	POLYCARBONATE	POLYESTER, GLASS THERMOSET	POLYETHERIMIDE	POLYRTHYLENE	POLYPROPYLENE	POLYSULFONE	POLYVINYL CHLORIDE	RULON A, TEFLON	SILICONE RUBBER	STAINLESS STEEL	TITANIUM	TYGON	VITON
N, N-Dimethylformamide	S	S	S	U	S	M	S	-	S	S	U	S	U	S	U	U	-	S	S	U	U	S	M	S	S	S	U	
Sodium Borate	M	S	S	S	S	S	S	S	S	S	S	U	S	S	S	S	-	S	S	S	S	S	S	M	S	S	S	
Sodium Bromide	U	S	S	-	S	S	S	-	S	S	S	S	S	S	S	S	-	S	S	S	S	S	S	M	S	S	S	
Sodium Carbonate (2%)	M	U	S	S	S	S	S	S	S	S	S	S	S	S	U	S	S	S	S	S	S	S	S	S	S	S	S	
Sodium Dodecyl Sulfate	S	S	S	-	S	S	S	-	S	S	S	S	S	S	S	-	S	S	S	S	S	S	S	S	S	S	S	
Sodium Hypochlorite (5%)	U	U	M	S	S	M	U	S	S	M	S	S	S	M	S	S	S	S	M	S	S	S	M	U	S	M	S	
Sodium Iodide	M	S	S	-	S	S	S	-	S	S	S	S	S	S	S	-	-	S	S	S	S	S	S	M	S	S	S	
Sodium Nitrate	S	S	S	-	S	S	S	S	S	S	S	S	S	S	S	S	-	S	S	S	S	S	U	S	S	S	S	
Sodium Sulfate	U	S	S	-	S	S	S	S	S	S	S	S	S	S	S	S	S	S	S	S	S	S	S	M	S	S	S	
Sodium Sulfide	S	-	S	S	-	-	-	S	-	-	-	S	S	S	U	U	-	-	S	-	-	-	S	S	M	-	S	
Sodium Sulfite	S	S	S	-	S	S	S	S	M	S	S	S	S	S	S	S	M	-	S	S	S	S	S	S	S	S	S	
Nickel Salts	U	S	S	S	S	S	-	S	S	S	-	-	S	S	S	S	-	S	S	S	S	S	S	M	S	S	S	
Oils (Petroleum)	S	S	S	-	-	-	S	U	S	S	S	S	U	U	M	S	M	U	U	S	S	S	U	S	S	S	S	
Oils (Other)	S	-	S	-	-	-	S	M	S	S	S	S	U	S	S	S	S	U	S	S	S	S	-	S	S	M	S	
Oleic Acid	S	-	U	S	S	S	U	U	S	U	S	S	M	S	S	S	S	S	S	S	S	S	M	U	S	M	M	
Oxalic Acid	U	U	M	S	S	S	U	S	S	S	S	S	U	S	U	S	S	S	S	S	S	S	S	U	M	S	S	
Perchloric Acid (10%)	U	-	U	-	S	U	U	-	S	M	M	-	-	M	U	M	S	M	M	-	M	S	U	-	S	-	S	
Perchloric Acid (70%)	U	U	U	-	-	U	U	-	S	U	M	U	U	M	U	U	U	M	M	U	M	S	U	U	S	U	S	
Phenol (5%)	U	S	U	-	S	M	M	-	S	U	M	U	U	S	U	M	S	M	S	U	U	S	U	M	M	M	S	
Phenol (50%)	U	S	U	-	S	U	M	-	S	U	M	U	U	U	U	U	S	U	M	U	U	S	U	U	U	M	S	
Phosphoric Acid (10%)	U	U	M	S	S	S	U	S	S	S	S	U	-	S	S	S	S	S	S	S	S	S	U	M	U	S	S	
Phosphoric Acid (conc.)	U	U	M	M	-	-	U	S	-	M	S	U	U	M	M	S	S	S	M	S	M	S	U	M	U	-	S	
Physiologic Media (Serum, Urine)	M	S	S	S	-	-	S	-	S	S	S	S	S	S	S	S	S	S	S	S	S	S	S	S	S	S	S	
Picric Acid	S	S	U	-	S	M	S	S	S	M	S	U	S	S	S	U	S	S	S	S	U	S	U	M	S	M	S	
Pyridine (50%)	U	S	U	U	S	U	U	-	U	S	S	U	U	M	U	U	-	U	S	M	U	S	S	U	U	U	U	
Rubidium Bromide	M	S	S	-	S	S	S	-	S	S	S	S	S	S	S	-	-	S	S	S	S	S	S	M	S	S	S	
Rubidium Chloride	M	S	S	-	S	S	S	-	S	S	S	S	S	S	S	-	-	S	S	S	S	S	S	M	S	S	S	
Sucrose	M	S	S	-	S	S	S	S	S	S	S	S	S	S	S	S	S	S	S	S	S	S	S	S	S	S	S	
Sucrose, Alkaline	M	S	S	-	S	S	S	-	S	S	S	S	S	S	U	S	S	S	S	S	S	S	S	M	S	S	S	
Sulfosalicylic Acid	U	U	S	S	S	S	S	-	S	S	S	U	S	S	S	-	S	S	S	-	S	S	U	S	S	S	S	
Nitric Acid (10%)	U	S	U	S	S	U	U	-	S	U	S	U	-	S	S	S	S	S	S	S	S	S	M	S	S	S	S	
Nitric Acid (50%)	U	S	U	M	S	U	U	-	S	U	S	U	U	M	M	U	M	M	M	S	S	S	U	S	S	M	S	

CHEMICAL	MATERIAL																										
	ALUMINUM	ANODIC COATING for ALUMINUM	BUNA N	CELLULOSE ACETATE BUTYRATE	POLYURETHANE ROTOR PAINT	COMPOSITE Carbon Fiber/Epoxy	DELRIN	ETHYLENE PROPYLENE	GLASS	NEOPRENE	NORYL	NYLON	PET*, POLYCLEAR, CLEARCRIMP	POLYALLOMER	POLYCARBONATE	POLYESTER, GLASS THERMOSET	POLYETHERIMIDE	POLYRTHYLENE	POLYPROPYLENE	POLYSULFONE	POLYVINYL CHLORIDE	RULON A, TEFLON	SILICONE RUBBER	STAINLESS STEEL	TITANIUM	TYGON	VITON
Nitric Acid (95%)	U	-	U	U	-	U	U	-	-	U	U	U	U	M	U	U	U	U	M	U	U	S	U	S	S	-	S
Hydrochloric Acid (10%)	U	U	M	S	S	S	U	-	S	S	S	U	U	S	U	S	S	S	S	S	S	S	S	U	M	S	S
Hydrochloric Acid (50%)	U	U	U	U	S	U	U	-	S	M	S	U	U	M	U	U	S	S	S	S	M	S	M	U	U	M	M
Sulfuric Acid (10%)	M	U	U	S	S	U	U	-	S	S	M	U	S	S	S	S	S	S	S	S	S	S	U	U	U	S	S
Sulfuric Acid (50%)	M	U	U	U	S	U	U	-	S	S	M	U	U	S	U	U	M	S	S	S	S	S	U	U	U	M	S
Schwefelsäure (konz.)	M	U	U	U	-	U	U	M	-	-	M	U	U	S	U	U	U	M	S	U	M	S	U	U	U	-	S
Stearic Acid	S	-	S	-	-	-	S	M	S	S	S	S	-	S	S	S	S	S	S	S	S	S	M	M	S	S	S
Tetrahydrofuran	S	S	U	U	S	U	U	M	S	U	U	S	U	U	U	-	M	U	U	U	U	S	U	S	S	U	U
Toluene	S	S	U	U	S	S	M	U	S	U	U	S	U	U	U	S	U	M	U	U	U	S	U	S	U	U	M
Trichloroacetic Acid	U	U	U	-	S	S	U	M	S	U	S	U	U	S	M	-	M	S	S	U	U	S	U	U	U	M	U
Trichloroethane	S	-	U	-	-	-	M	U	-	U	-	S	U	U	U	U	U	U	U	U	U	S	U	-	S	-	S
Trichloroethylene	-	-	U	U	-	-	-	U	-	U	-	S	U	U	U	U	U	U	U	U	U	S	U	-	U	-	S
Trisodium Phosphate	-	-	-	S	-	-	M	-	-	-	-	-	-	S	-	-	S	S	S	-	-	S	-	-	S	-	S
Tris Buffer (neutral pH)	U	S	S	S	S	S	S	-	S	S	S	S	S	S	S	S	S	S	S	S	S	S	S	S	S	S	S
Triton X-100	S	S	S	-	S	S	S	-	S	S	S	S	S	S	S	S	S	S	S	S	S	S	S	S	S	S	S
Urea	S	-	U	S	S	S	S	-	-	-	-	S	S	S	M	S	S	S	S	-	S	S	S	M	S	-	S
Hydrogen Peroxide (10%)	U	U	M	S	S	U	U	-	S	S	S	U	S	S	S	M	U	S	S	S	S	S	S	M	S	U	S
Hydrogen Peroxide (3%)	S	M	S	S	S	-	S	-	S	S	S	S	S	S	S	S	M	S	S	S	S	S	S	S	S	S	S
Xylene	S	S	U	S	S	S	M	U	S	U	U	U	U	U	U	M	U	M	U	U	U	S	U	M	S	U	S
Zinc Chloride	U	U	S	S	S	S	U	S	S	S	S	S	S	S	S	S	S	S	S	S	S	S	S	U	S	S	S
Zinc Sulfate	U	S	S	-	S	S	S	S	S	S	S	S	S	S	S	S	S	S	S	S	S	S	S	S	S	S	S
Citric Acid (10%)	M	S	S	M	S	S	M	S	S	S	S	S	S	S	S	S	M	S	S	S	S	S	S	S	S	S	S

\*Polyethyleneterephthalate

**Key**

- S Satisfactory
- M Moderate attack, may be satisfactory for use in centrifuge depending on length of exposure, speed involved, etc. Suggest testing under actual conditions of use.
- U Unsatisfactory, not recommended.
- Performance unknown; suggest testing, using sample to avoid loss of valuable material.

Chemical resistance data is included only as a guide to product use. No organized chemical resistance data exists for materials under the stress of centrifugation. When in doubt we recommend pretesting sample lots.

## **A** Chemical Compatibility Chart



## Warranty

Thermo Fisher Scientific make no warranty of any kind, expressed or implied, except as stated in this warranty policy.

The Thermo Fisher Scientific RC6 Plus Superspeed centrifuge is warranted to be free from defects in material and workmanship for a period of one year from the date of delivery. The drive is warranted to be free of defects in material and workmanship for a period of three years from the date of delivery. The compressor, condenser, evaporator and all interconnecting tubing are warranted to be free of defects in material and workmanship for a period of five years from the date of delivery. Thermo Fisher Scientific will repair or replace and return free of charge any part which is returned to its factory within said period, transportation prepaid by user, and which is found upon inspection to have been defective in materials or workmanship. This warranty does not apply to any damage to any instrument resulting from: normal wear and tear, misuse, abuse, use of electrical currents or circuits other than those specified on the plate affixed to the instrument, accident, negligence, failure to follow operating instructions and user's manual, or use of any other rotor than a Thermo Fisher Scientific rotor intended for use in this instrument.

Thermo Fisher Scientific reserves the right to change, alter, modify, or improve any instruments without any obligation whatsoever to make corresponding changes to any instrument previously sold or shipped.

Extended Warranties are conditional on the instrument being correctly maintained by authorized Service Representatives on an annual basis.

The foregoing obligations are in lieu of all other obligations and liabilities including negligence and all warranties of merchantability or otherwise, expressed or implied in fact or by law, and state our entire and exclusive liability and buyer's exclusive remedy for any claim or damages in connection with the sale or furnishing of goods or parts, their design, suitability for use, installation or consequential damages whatsoever, and our liability under no circumstances will exceed the contract price for the goods for which liability is claimed.

Terms may vary by country. Please contact your local sales office for further information.



## Contact Information

Country	Telephone number
United States /Canada	866-9-THERMO +1 866 984 3766
Austria	+43 1 801 400
Belgium	+32 53 73 42 41
Germany	08001 536 376 +49 6184 90 6940
France	+33 2 2803 2180
Italy	+39 02 95059 448
Netherlands	+31 76 571 4440
Nordic / Baltic Countries / CIS	+358 9 329 10200
Russia	+7 (812) 703 42 15
Spain / Portugal	+34 932 23 09 18
Switzerland	+41 44 454 12 12
UK / Ireland	+44 870 609 9203
Australia	+61 39757 4300
China	+86 21 6865 4588 +86 10 8419 3588
India	1800 22 8374 +91 22 6716 2200
Japan	+81 45 453 9220
Other Asian Countries	+852 2885 4613
New Zealand	+64 9 980 6700
Latin America	+1 866 984 3766
Other Countries	+49 6184 90 6940



<b>A</b>		<b>M</b>	
Accident Prevention .....	iv	Mains Connection .....	2-5
Aligning the Centrifuge .....	2-5	Maintenance .....	6-1
Autoclaving .....	6-5		
<b>C</b>		<b>O</b>	
Care .....	6-1	Operation .....	4-1
Centrifuging .....	4-5		
Cleaning .....	6-2	<b>P</b>	
Cleaning Agents .....	6-3	Precautions .....	iv
Close Lid .....	4-2	Preface .....	iii
Contact Information .....	C-1	Preselecting RCF .....	4-3
		Preselecting Speed .....	4-3, 4-4
<b>D</b>		Preselecting the Temperature .....	4-5
Decontamination .....	6-5	preset running time .....	4-5
Disinfection .....	6-4		
<b>E</b>		<b>R</b>	
Explanation of RCF Value .....	4-4	Rotor Installation .....	4-3
<b>F</b>			
Failure message .....	7-3	<b>S</b>	
<b>H</b>		Service Technician .....	6-6
HOLD Run .....	4-6	Setting up Location .....	2-2, 2-5
<b>I</b>		Starting centrifuge program .....	4-5
Imbalance indicator .....	4-5	Stopping the centrifuging program .....	4-5
Intended Purpose .....	vi	Storage .....	2-6
<b>K</b>		<b>T</b>	
Keys .....	3-2	Transporting the Centrifuge .....	2-5
<b>L</b>		Troubleshooting .....	7-1
Lid Opening .....	4-2		





