

Operating instructions

Hot-Air Disinfectable Gassed Incubator BBD 6220



Read this operating instructions and keep it near the equipment for reference purposes !

Valid: 03.2006 / 50 079 041 A

Thermo
ELECTRON CORPORATION

<p>Postal address Germany Thermo Electron LED GmbH Robert-Bosch-Straße 1 D - 63505 Langenselbold</p> <p>Enquiries from Germany Phone Sale 0800 1 536376 Service 0800 1 112110 Fax Sale/Service 0800 1 112114 E-Mail info.labequipment.de@thermo.com</p> <p>Enquiries from Europe, Middle East and Africa Tel. + 49 (0) 6184 / 90-6940 Fax + 49 (0) 6184 / 90-7474 E-Mail info.labequipment.de@thermo.com</p>	<p>Postal address USA Thermo Electron Corporation 275 Aiken Road Asheville, NC 28804 USA</p> <p>Enquiries from North America Phone +1 800-879 7767 Fax +1 828-658 0363 E-Mail info.labequipment.de@thermo.com</p> <p>Enquiries from Latin America Phone +1 828-658 2711 Fax +1 828-645 9466 E-Mail iinfo.labequipment.de@thermo.com</p> <p>Enquiries from Asia Pacific Phone +852-2711 3910 Fax +852-2711 3858 E-Mail info.labequipment.de@thermo.com</p>
--	--

Copyright © Thermo Electron GmbH, D-63505 Langenselbold, Deutschland

No part of this publication may be reproduced or transmitted in any form or by any means, including photocopying and recording, without the written permission of Thermo Electron GmbH.

Various sections of this instruction manual may be copied only for in-house use by the equipment operator, e.g. to provide employees with instructions on accident prevention measures. These sections are **clearly marked in the list of contents.**

Thermo Electron GmbH can accept no liability or responsibility for the marketability or the suitability of this instruction manual for a certain purpose other than that specified under "Areas of application of equipment".

Thermo Electron GmbH reserves the right to change the content of this instruction manual at any time and without prior notice.

As regards foreign-language translations, the German version of this instruction manual is binding.

This edition of the instruction manual applies to the BBD 6220 unit specified on the front page.

Date of publication: 03.2006

Nominal charge



Safety with regard to the protection of persons, the environment and the material under process largely depends on the conduct of the persons using the equipment.

This instruction manual is important for your safety as well as for the setup, installation, use and maintenance of the equipment!









To avoid errors and any resulting damage, especially personal injuries, be sure to read this manual carefully before using the equipment and follow all instructions.

1. GENERAL	5/7
Explanation of icons in the instructions manual	5
Explanation of icons in the short instructions	6
General instructions	7
Equipment log book	7
Operating instructions	7
2. AREAS OF APPLICATION	8
3. SAFETY INSTRUCTIONS	9
4. SETUP AND INSTALLATION	10-12
Transport	10
Place of installation	10
Stacking	10
Clearances	11
Supply connections	11
Mains connection	11
Gas supply connection	12
RS 232 interface	12
"Potential-free contact" connection	12
5. DESCRIPTION OF THE UNIT	13/14
Levelling the shelves	13
Functional principle	13
Heating system	13
Gassing	13
Humidification	14
Door switch	14
Internal fittings	14
Six-piece Gas-tight glass screen	14
Lockable outside door	14
Disinfection routine	14
"Potential-free contact" connection	14
6. OPERATE	15-30
Switch panel	15
Water supply	16
Mains switch	16
Temperature protection device (temperature limit controller)	18
Control and display panels	18-21
Disinfection routine	21/22
auto-start routine / <i>auto-zero routine</i>	23/24
Error code enquiry	23/25
Switching functions	27
Switching function: Acoustic alarm ON/OFF	27
Switching function: Humidification ON/OFF	28
Switching function: Manual zero calibration of CO ₂ measuring system	29
Switching function: Setpoint lock-in ON/OFF	30
Switching function: Door heater ON/OFF	31

7. START-UP	32
8. OPERATION	33
Guidelines for use	33
Before putting the unit into operation	33
During operation	33
Operation interruptions	33
9. SHUTDOWN	34
10. MAINTENANCE	35/36
Cleaning/Disinfection	35
Testing	36
Equipment log book	36
Replacing of electrical parts	36
11. AUTHORIZED EQUIPMENT PARTS AND ACCESSORIES	37
12. TECHNICAL SPECIFICATIONS	38/39
13. MATERIALS USED / DISPOSAL	40
14. GAS CONSUMPTION	41
15. PH-VALUE OF CULTURE MEDIA	42
Basic rules of sound microbiological engineering practice	43/44
General rules	43
Handling of pathogenes	43/44
Handling of human- and animal-pathogenic biological agents	44
APPENDIX	
Statement of conformity	
Log Book	
Explanation of confirmation of safety	
Information request form regarding maintenance and servicing contract	
Communication-protocol of RS 232-device	





1. GENERAL

EXPLANATION OF ICONS IN THE INSTRUCTIONS MANUAL

	In chapters of the instruction manual which deal with safety, this icon appears under the title of the chapter. Displayed on the equipment, this icon denotes that special attention must be paid to the information given in the instruction manual or accompanying documents.
	Marks information in the instruction manual for optimizing use of the equipment
	"Water supply" vent/overflow
 aqua dest	"Add/drain water" quick release coupling
I	Unit ON
0	Unit OFF
des start/ stop	"Disinfection mode" key-operated switch
	Marks information for higher surface temperature in the disinfection mode
	Overtemperature protection, temperature limit controller
	Selection of switching/interlocking functions
i	Error code enquiry / acknowledgment of "acoustic signal"
control	"Change switching functions activated" display
auto-start	Automatic startup of unit and calibration of measuring systems
auto-zero	"auto-zero" calibration active display
des	"Disinfection mode" display
	Information on proper disposal / recovery of raw materials

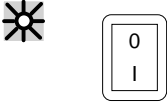
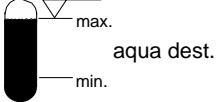
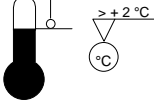
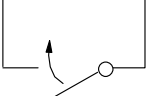
1. GENERAL

EXPLANATION OF ICONS TO THE SHORT INSTRUCTIONS

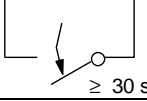
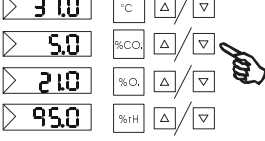
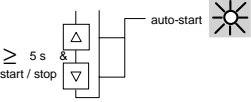
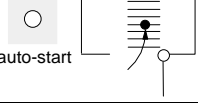
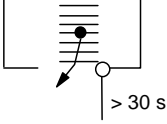
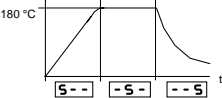
	<p>Switch on unit (operate the main switch)</p>
	<p>Check the water level</p>
	<p>Set the temperature limit controller</p>
	<p>Close unit doors</p>
	<p>Read the operating instructions</p>
	<p>Start "disinfection routine"</p>
<p>auto-start</p> 	<p>automatical "auto-start"</p>
	<p>Open unit doors for at least 30 seconds</p>
	<p>Set the desired setpoints</p>
	<p>"activate" the auto-start</p>
	<p>End of the auto-start, bring in the samples</p>
	<p>Take out the samples, open unit doors for at least 30 seconds</p>
	<p>Flow chart of disinfection routine</p>

1. GENERAL



General instructions



To avoid errors and causing damage, especially personal injuries, be sure to read this manual carefully before using the equipment, and follow all instructions.

When setting up and operating the unit, be sure to comply with the instructions contained in this manual as well as all applicable laws, regulations and directives in your country (FRG: ZH 1/119, ZH 1/342, ZH 1/343, ZH 1/598).

The unit meets the following safety requirements

- DIN 12880 Part 1/11.78
- DIN VDE 0700 Part 1 (IEC 335-1; EN 60335-1/11.90)
- EN 61010

When you have an enquiry, order replacement parts or file a complaint, please state the data on the nameplate and, if applicable, the fault code.

Equipment log book

We advise you to keep an equipment log book.

Keep a record of inspections and testing, calibration work and any major work carried out on the unit - such as maintenance, agents loaded, etc. - in this log book (refer to APPENDIX).

Operating instructions

The operator (employer) is expected to provide anyone who works on or with the equipment with **written instructions**, based on this instruction manual, for the tasks to be performed. These instructions should be easy to understand and in the language of the persons operating the equipment.

This also applies to disinfecting and cleaning the unit (also refer to Chapter 10: Maintenance).

2. AREAS OF APPLICATION



The BBD 6220 gassed incubator is an item of laboratory equipment for cell and tissue cultures and can be used to simulate the physiological environmental conditions of cells.

The unit is generally suitable for setup and operation in the following areas:

- In laboratories for microbiological and biotechnological work.
- Medical and microbiological laboratories to DIN 58956.
- Central laboratories in clinics and hospitals.
- Laboratories operating at safety levels L1, L2 and L3.



Only organisms which comply with the requirements for safety levels L1, L2 and L3 may be handled in the unit.

The unit must be set up and operated in accordance with all applicable regulations in your country. (FRG: ZH 1/119, ZH 1/342, ZH 1/343, ZH 1/598)

It is not permitted to handle gases or agents whose vapours are combustible or can form a hazardous, potentially explosive atmosphere when mixed with air.
Be sure to comply with the applicable regulations in your country.
(FRG: ZH 1/10)

3. SAFETY INSTRUCTIONS



- In the case of biological incubators, biological safety with regard to the protection of persons, its surroundings and the load is heavily dependent on the observance of the applicable regulations by the persons using the equipment.

Even then, however, the possibility of hazards, especially health hazards, arising cannot be ruled out.

The residual risk depends on the work performed in each individual case.

To avoid errors and causing damage, especially personal injuries, be sure to carefully read this manual before putting the equipment into operation, and follow all instructions.

- Safe and reliable operation of the unit can only be guaranteed if the necessary inspections, maintenance and repair work are carried out by Heraeus Service Department personnel or by personnel authorized by our company.
- Gas is to be supplied to each unit by means of a **pressure reducer** with the inlet pressure set to **between 0.8 and max. 1 bar**. This setting must **not** be changed for safety reasons (FRG: ZH 1/119).
- The place of installation must be thoroughly ventilated in order to expel the gases escaping around the pressure relief valve to the outside.
- To maintain the temperature protection function, the functioning of the overtemperature protection device, temperatur limit controller must be checked at reasonable intervals.
- Only original replacement parts authorized by the manufacturer are to be used.
- Refer to the Appendix titled "BASIC RULES OF SOUND MICROBIOLOGICAL ENGINEERING PRACTICE".

4. SETUP AND INSTALLATION



When setting up, installing and operating the unit, be sure to comply with all applicable regulations in your country. (FRG: ZH 1/119, ZH 1/342, ZH 1/343, ZH 1/598)

Transport

Handle the unit with care during transport. Do not lift up the unit by its door.
Refer to TECHNICAL SPECIFICATIONS for weights and dimensions.

Place of installation

The place of installation must be dry and draught-free.

The unit should not be placed or operated in recesses which cannot be ventilated.



To avoid or at least minimize deviations from the technical specifications, the temperature at the place of installation must be in the range +18°C to +30°C.

Set up the unit on a solid, non-flammable surface (laboratory tables, subframes).

Make sure that the unit is in a stable and perfectly upright position.

Do not cover or obstruct the fresh air or exhaust vents in the unit housing
(please observe the minimum clearances - see page 11).

CO₂ are admitted into the gassed incubator. CO₂ is a **health risk hazard**. The place of installation must therefore be well-ventilated.

Gases discharged from the pressure relief valve must be safely expelled outside by means of the ventilation systems.

It may be necessary to take special measures in order to ensure proper ventilation when several units are installed in the same room.

For information on gas flow during operation, refer to the APPENDIX.

Stacking

The unit is not suitable for stacking when operated in the manner intended.

4. SETUP AND INSTALLATION

Clearances

When setting up the unit, the minimum clearances between the unit and adjacent surfaces and other units must be maintained.

Larger clearances are recommended to facilitate accessibility for installation and the supply connections.

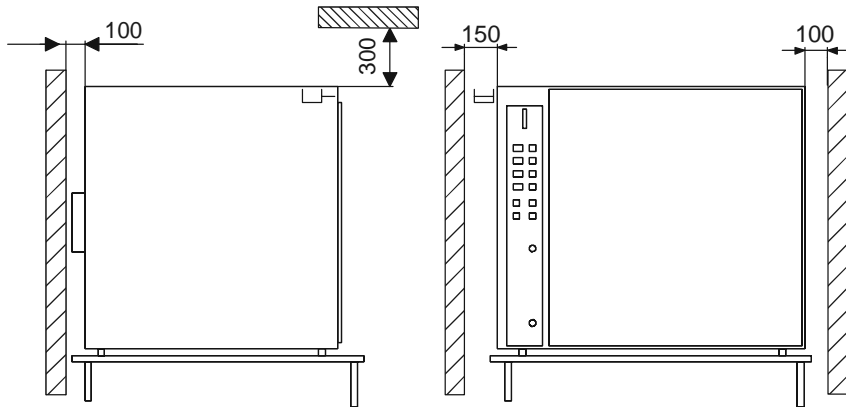

Fig. 1: Minimum clearances in mm

Supply connections

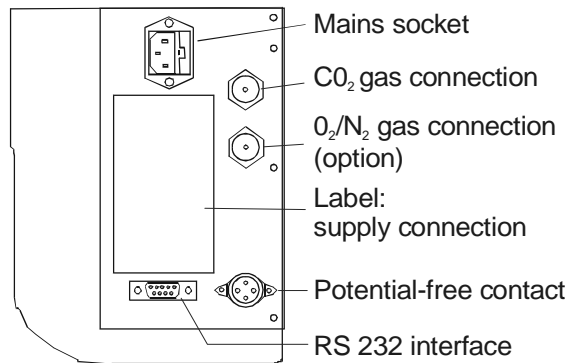

Fig. 2: Supply connections (rear panel of unit)

Mains connection

Prior to connecting the unit to the mains, make sure that the power supply ratings match those stated on the nameplate.

Your unit is equipped with a power supply cable with a grounding contact-type plug.

Fuse protection required:

- Use a type G 16 circuit-break switch or a type T 16 A fusible cutout.

Refer to the Chapter titled TECHNICAL SPECIFICATIONS for unit power consumption.

4. SETUP AND INSTALLATION

Gas supply connection

The gas connection are located on the back of the unit.



The gas must be supplied to each unit via a pressure reducer with the **inlet pressure set to between 0.8 and max. 1 bar.**

This setting must **not** be changed for safety reasons (FRG: ZH 1/119).



The gases must have **at least 99.5%** purity.

If several units are placed in the same room, special ventilation measures are required.

- CO₂ gassing
Connect the gas cylinder to the gas nozzle on the unit.
- O₂ / N₂ gassing (optional)
If you intend to run the unit with an oxygen content above 21%, connect an oxygen cylinder.
If you intend to run the unit with an oxygen content less than 21%, connect a nitrogen cylinder.
To deactivate the oxygen control, set the nominal value to 21.0% (average oxygen content of ambient atmosphere).

RS 232 interface

Serial interface for computer-aided acquisition and documentation of critical operating parameters (temperature, CO₂, relative humidity, error codes, etc.). The RS 232 interface can connect a single unit in combination with the "Kelvilog"[®] software package, and can be expanded to connect 31 units with the "Netcontrol"[®] hard- and software package.

"Potential - free contact" connection

The "Potential-free contact" (1 changeover contact) is rated for the following circuits:

Circuit	Voltage	Fuse to be installed by customer
Mains-operated circuits	max. 250 V AC	max. 6 A
SELV / SELV - E - circuits (cf. VDE 0100 Part 410)	25/50 V AC 60/120 V DC	max. 2/1 A max. 1/0.5 A

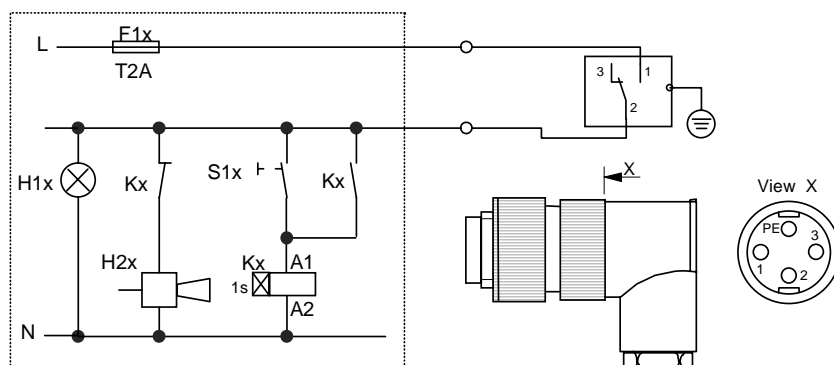

Fig. 3 : Application example of "Potential - free contact" connection

5. DESCRIPTION OF THE UNIT

Levelling the shelves



The shelves can be aligned with the aid of a spirit level with height-adjustable feet.

Functional principle

The atmosphere in the chamber can be regulated in relation to its temperature, CO₂ concentration, O₂ concentration (optional) and relative humidity.

Heating system

The temperature inside the unit can be regulated in the range of +7°C to +50°C, but must be at least +5°C (approx. +7°C for the O₂ version) above the ambient temperature of the unit. Condensation on the glass door is largely prevented by heating the unit door. If the unit door is left open for a long period of time, however, condensation cannot be ruled out.



The unit door heater can be switched off as required (refer to Chapter headed OPERATION). This enables the unit to be operated at high ambient temperatures or when the operating temperature is only supposed to exceed the ambient temperature by approx. +4°C.

Example:

Ambient temperature	Operating temp.	Heating of unit door
+25°C	+37°C	ON
+24°C	+28°C	OFF
+32°C to +33°C	+37°C	OFF

Gassing

Connection to the gas supplies (CO₂, O₂ or rather N₂) are located on the rear panel of the incubator.

- The CO₂ content of the atmosphere in the chamber can be regulated in the range 0% to 20%.
- The O₂ concentration inside the unit can be regulated in the range 3% to 90% O₂ by admitting N₂ (< 21% O₂) or O₂ (> 21% O₂).
- The sum of the nominal values for CO₂ + O₂ must not exceed 90%.

Example: 10% CO₂ + 80% O₂ = 90% (possible)
20% CO₂ + 80% O₂ = 100% (impossible)

Before entering the chamber, all gases pass through a filter where particles larger than 0.3 µm are retained. Filter efficiency is 99.998%.

A fan integrated in the rear of the interior wall ensures that the gases and the incubator atmosphere are thoroughly mixed.

The sensors for CO₂, O₂ (option) and relative humidity are also located on the rear panel of the interior wall. These sensors measure the parameters inside the unit and transmit corresponding signals to the closed-loop controller.

A pressure compensation vent on the rear panel of unit avoids undesirable pressure build-up inside the unit during the admission of gases.



The place of installation must be thoroughly ventilated in order to expel the gases escaping around pressure compensation vent.

5. DESCRIPTION OF THE UNIT

Humidification

The atmosphere in the chamber is humidified through the admission of steam generated in a aktiv humidifier. Relative humidity (rH) can be regulated between 60% and 95%.



To ensure reliable operation of the steam generator, only fill the reservoir with fully desalinated or distilled water!

The capacity of the reservoir is approx. 4.7 ltr (difference between min. and max. levels: 2.2 ltr).

Door switch

The heating system, gas supply and humidifier are switched off when the unit door is opened.



The unit door can only be closed when all glass doors are sealed properly. If the unit door is not properly closed while the unit is in operation, a visual alarm is given (all LEDs flashing). If the door is open for longer than 10 minutes, an acoustic alarm sounds when this monitoring function is activated by way of function level 1 (refer to Page 26).

Internal fittings

Pull-out shelves, with support brackets to prevent tilting, are arranged inside the units. The support can be offset in the carrier racks at intervals of 46 mm.

Six-piece gas-tight glass screen

By virtue of the small vent cross-section, unnecessary cooling and discharge of the atmosphere in the chamber is largely avoided when a glass door is opened of the six-piece gas-tight glass screen.

Lockable outside door

The outside door is lockable.

Disinfection routine

This routine is for disinfecting the interior of the unit. In this process, the unit is heated to 180°C and kept at the disinfection temperature for approx. 3 hours. The unit is then automatically cooled down again and the nominal values for temperature, gases and relative humidity are reset. The entire procedure lasts approx. 13 hours, after which the unit is ready for operation again.

"Potential - free contact" connection

Connection for the customer's own signalling system, e.g. telephone system, building services management systems.

If the overtemperature-protection device trips or an error is detected by the diagnosis system, a fault message is sent to the customer's own signalling system.

6. OPERATE

Switch panel

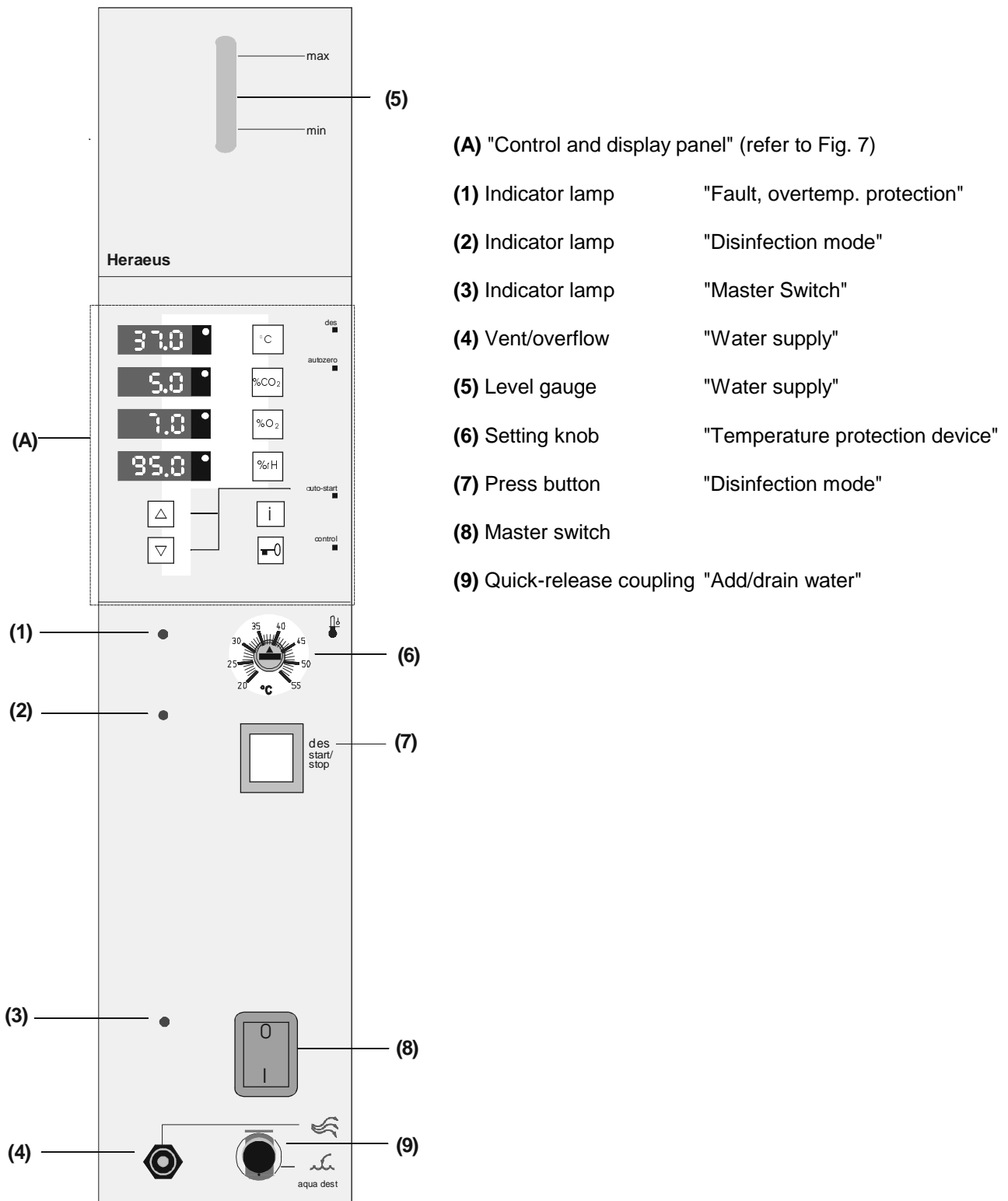

Fig. 4: Switch panel

6. OPERATE

Water supply

Level gauge (5)

- indicates the water level.
- The water level should be in the range between "**min and max**". This range is equivalent to a volume of 2.2 ltr. If the water supply falls below the "**min.**" level, a reserve of 0.5 ltr. is still available.

Filling the water reservoir

For humidification of the incubator, water of the following quality must be used:

- demineralised water that has been sterilised.
or
- sterile water that has been demineralised. Distilled or autoclaved water is suitable.

Fill the canister with the water and leave the screw cap off. Hang the canister on the bracket located on the upper left of the incubator. (fig 1) Connect the tubing connector (fig 1) into the quick fit coupling, the water reservoir will be filled under the force of gravity. Should the water not flow, there may be an airlock in the tube, in which case press on the tube bulb to move the air through.



Attention:

If the reservoir is overfilled the excess water any will flow from the overflow pipe.

After filling place the filling canister on the floor and allow water in the filling tube to return to the canister before removing the quick fit connection. (fig 2)



Attention:

After filling completely empty and dry the filling canister, store the canister dry to prevent the formation of contamination.



Figure 1



Figure 2

6. OPERATE



As the outlet not only functions as an overflow but also as a vent, it must be unsealed while the unit is in operation.

- To drain the empty filling canister, place it on the floor and connect it using the quick-release coupling **(9)**. Take care that the filling canister does not overflow. Disconnect the quick-release coupling if necessary.



Always drain the water reservoir before transporting the unit.

Mains switch

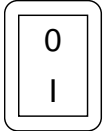

Unit OFF

Unit ON (the green indicator lamp **(3)** indicates that unit is ready for operation).

Fig. 5: Mains switch (8)

6. OPERATE

Temperature protection device (temperature limit controller)

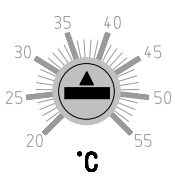

Fig. 6: Temperature limit controller (6)

A temperature protection device is built into the unit and acts as a temperature limit controller. It conforms to Thermal Safety Class 3.1 to DIN 12880 Part 1/11.78. In a functional state, the temperature limit controller assumes the control function if the set temperature is exceeded. The red indicator lamp (1) "Fault" lights up as soon as the temperature limit controller responds.

The cutout temperature of the temperature limit controller can be adjusted in the range +20°C to +55°C using a coin or screwdriver.



Have your temperature protection device tested for proper operation at reasonable intervals. This applies in particular before prolonged work processes.

Operational test:

Condition: Nominal temperature (controller) reached/constant.

To run this test, turn the dial on the Temperature Limit Controller so that it shows approx. +5°C less than the temperature indicated on the temperature controller.

If the Temperature Limit Controller responds and the red indicator lamp (1) "Fault" comes on, the Temperature Limit Controller is operating properly.

Now set the Temperature Limit Controller to the required value depending on the max. cutout temperature.

- If the Temperature Limit Controller is set to the upper temperature limit, it assumes the function of unit protection (protection of unit and surroundings).
- If the Temperature Limit Controller is set to approx. +2°C above the nominal temperature set at the temperature controller, it assumes the function of load protection (protection of unit, its environment and loaded material).



The load protection function is only effective above room temperature.

If "Fault" is displayed during operation:

- Check the settings on the Temperature Limit Controller and the controller, and correct them if necessary. If the fault cannot be rectified, contact our service department.

Control and display panel (A)

Microprocessor-controlled controller with digital temperature, CO₂, O₂ (optional) and relative humidity displays.

The controller has the following functions:

- Temperature "set, display and control"
- CO₂ concentration "set, display and control"
- O₂ concentration "set, display and control" (OPTIONAL)
- Relative humidity "set, display and control"
- Error code "scan"
- auto-start function "activate"
- Switching functions
 - Acoustic alarm "switch ON/OFF"
 - Humidification "switch ON/OFF"
 - Manual calibration of CO₂ measuring system "execute"
 - Setpoint lock-in "select ON/OFF"
 - Door heater "switch ON/OFF"

6. OPERATE

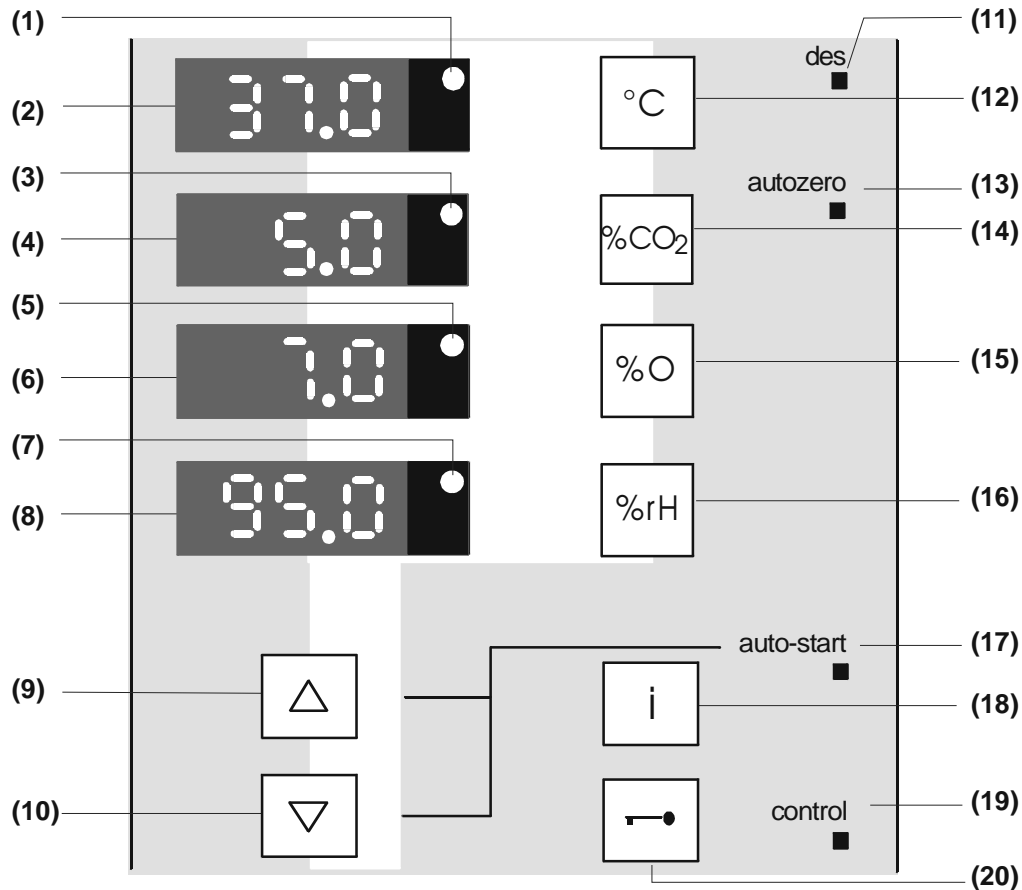

Fig. 7: Control and display panel (A)



(1) Indicator lamp	"HEATING"	(11) Indicator lamp	"Disinfection mode"
(2) Display	"Temperature"	(12) Key	"Temperature setpoint"
(3) Indicator lamp	"CO ₂ GASSING"	(13) Indicator lamp	"auto-zero"
(4) Display	"CO ₂ concentration"	(14) Key	"CO ₂ setpoint"
(5) Indicator lamp	"O ₂ /N ₂ GASSING" (optional)	(15) Key	"O ₂ setpoint" (optional)
(6) Display	"O ₂ concentration" (optional)	(16) Key	"Relative humidity setpoint"
(7) Indicator lamp	"HUMIDIFICATION"	(17) Indicator lamp	"auto-start"
(8) Display	"Relative humidity"	(18) Key	"Error code inquiry" / Start calibration routines
(9) Key	"Increase reading"	(19) Indicator lamp	"Control"
(10) Key	"Decrease reading"	(20) Key	"Switching functions"

6. OPERATE



In its as-delivered condition, the unit is preset to the following values:

Temperature: **37.0°C**
 CO₂ concentration: **0.0%**
 O₂ concentration: **21.0% (optional)**
 Relative humidity: **60.0%**, humidity control activated via function level 2



Setting the temperature setpoint:

Instruction	Entry / Keys / Remarks	Display / Remarks / Status
Switch on unit (master switch = " I ")	All display elements come on for approx. 15 seconds. - Auto-test of controller -	Example: 
Display temperature setpoint	°C press	Actual setpoint is displayed and decimal point flashes
Select temperature setpoint	°C &  press	Setpoint increases
	°C &  press	Setpoint decreases
Adopt NEW temperature setpoint	°C release	Temperature inside unit is displayed

Setting the CO₂ setpoint:

Instruction	Entry / Keys / Remarks	Display / Remarks / Status
Display CO ₂ setpoint	%CO ₂ press	Actual setpoint is displayed and decimal point flashes
Select CO ₂ setpoint	%CO ₂ &  drücken	Setpoint increases
	%CO ₂ &  drücken	Setpoint decreases
Adopt NEW CO ₂ setpoint	%CO ₂ release	CO ₂ concentration inside unit is displayed







Setting the O₂ setpoint (optional):

Instruction	Entry / Keys / Remarks	Display / Remarks / Status
Display O ₂ setpoint	%O ₂ press	Actual setpoint is displayed, decimal point flashes
Select O ₂ setpoint	%O ₂ &  press	Setpoint increases
	%O ₂ &  press	Setpoint decreases
Adopt NEW O ₂ setpoint	%O ₂ release	O ₂ concentration inside unit is displayed

The control is deactivated when the unit is set for 21% O₂ since this corresponds to the O₂ content of air.

6. OPERATE

Setting the relative humidity setpoint:

Instruction	Entry / Keys / Remarks	Display / Remarks / Status
Display the relative humidity setpoint	 press	Actual setpoint is displayed and decimal point flashes
Set the relative humidity setpoint	 &  press	Setpoint increases
	 &  press	Setpoint decreases
Adopt NEW relative humidity setpoint	 release	Relative humidity concentration inside the unit is displayed

Disinfection routine

The entire interior of the unit together with all sensors can be disinfected with hot air at 180°C. The disinfection routine lasts approx. 13 hours.

Start disinfection routine:

Instruction	Entry / Keys / Remarks	Display / Remarks / Status
Open the unit door for at least 30 seconds		All displays flash
Remove samples and vessels from the interior of the unit		
Activate the disinfection routine (turn key in direction of arrow)	 Press for approx. 1 second	Indicator Lamp (page 19 (11)) flashes and indicator lamp (page 15 (2)) comes on.
Close the door		Disinfection routine runs automatically. Temperature Limit Controller is disabled. CO ₂ display indicates the phases of the disinfection routine. "auto-start" routine begins on completion of the disinfection routine .



In the disinfection mode (appr. 13 h) occur slightly higher temperatures on the outer surface, the door area and the internal door grip. When LED "des" is flashing, proceed with particular caution.
Avoid touching the door areas during the disinfection routine.

6. OPERATE

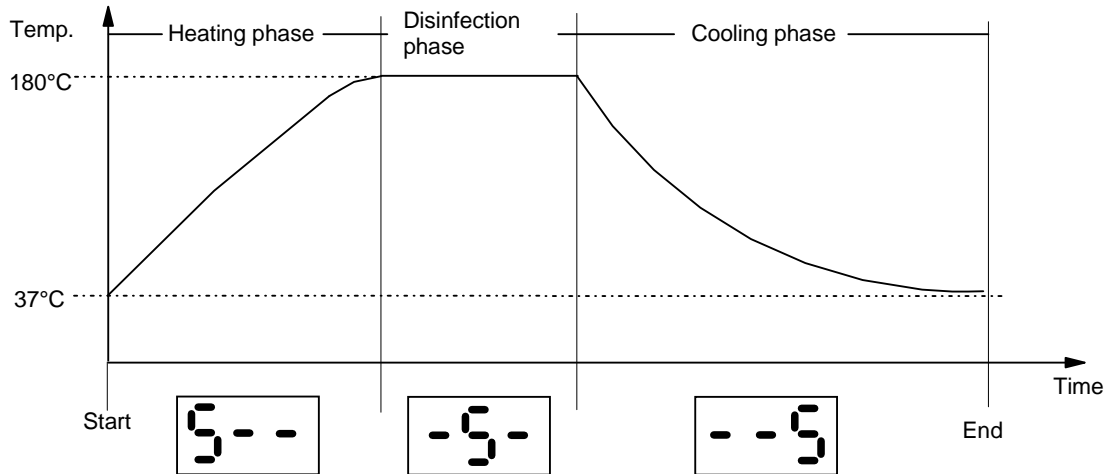

Flow chart of disinfection routine:

Status display on CO₂ display:

5-- Heat:

The chamber is heated to 180°C; the disinfection temperature can be read off the temperature display.

-5- Disinfect:

When the disinfection temperature of 180°C is reached, a disinfection phase with a duration of approx. 3 hours is started. If the door is opened during the period and the temperature drops below 180°C, the disinfection routine restarts automatically.

--5 Cool:

On completion of the disinfection phase, the unit cools down to the originally set nominal temperature.

- The yellow indicator lamp "des" as soon as the unit reaches the set operating temperature (e.g. 37.0°C) is reached. The sensors are automatically calibrated (auto-start) and the unit is readjusted to the set gas / rel. humidity setpoints. The disinfection routine is completed.
- If a temperature of 200°C is exceeded during the disinfection routine, the latter is cancelled and all poles of the heating system are disconnected. Error message 501 is displayed.

Cancelling the disinfection routine:

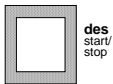
Instruction	Entry / Keys / Remarks	Display / Remarks / Status
Cancel disinfection	 Press for approx. 1 second	The CO ₂ display indicates the cooling phase of the disinfection routine.

6. OPERATE

auto-start routine / auto-zero routine

An auto-start routine / *auto-zero routine* will have to be run when putting the unit into operation or if the temperature setpoint is altered by more than 1°C.





To ensure that there is only air, i.e. no CO₂ in the chamber before the auto-start routine is activated, ventilate the chamber by opening all doors.

The auto-start can only be activated if the doors are open for at least 30 s.

The indicator lamp "auto-start" (page 19 (17)) indicates when the auto-start routine is running. Calibration can take up to 5 hours, especially if the unit is cold.

If the unit door is opened during the auto-start, the auto-start routine / *auto-zero routine* restarts automatically after the unit door is closed.

On resumption of the power supply after a power failure, the auto-start routine / *auto-zero routine* is also restarted.

Instruction	Entry / Keys / Remarks	Display / Remarks / Status
Open unit doors for at least 30 seconds		All display segments flash
Adjust or check the set-points	Refer to pages 20	
Activate auto-start	 &  Press for approx. 5 seconds	Indicator lamp (page 19 (17)) "auto-start" flashes
Close all unit doors		Temperature reads "Actual value" CO ₂ reads " 0.0" O ₂ reads "21.0" (optional) rel. humidity reads "Actual value"





The unit is set to the temperature and relative humidity setpoints. When temperature and relative humidity setpoints are achieved consistently, the CO₂ measuring system is automatically calibrated and the O₂ sensor (optional) is calibrated for 21%.

- Indicator lamp (page 18 (17)) "auto-start" goes out.
- The *auto-zero routine* determines the reference value and O₂ sensor (optional) is calibrated.
- Gas is admitted until the CO₂/O₂ setpoints are reached.

The *auto-zero routine compensates* for zero drift of the CO₂ measuring cell. The auto-zero routine runs automatically every 6 hours. When the indicator lamp (page 19 (13)) "*auto-zero*" is flashing, the auto-zero routine is in progress. If the door is opened or closed during the auto-zero routine, *auto-zero calibration* is restarted.

If the auto-start has not been completed after 24 hours at the latest (page 19, indicator lamp (17) "auto-start" is still flashing), the auto-start will have to be cancelled manually (refer to page 24) and repeat.

6. OPERATE

Instruction	Entry / Keys / Remarks	Display / Remarks / Status
Cancel auto-start routine	 &  Press for approx. 5 seconds	Indicator lamp (page 19 (17)) "auto-start" goes out and auto-zero calibration routine starts
		Indicator lamp (page 19 (13)) "auto-zero" flashes
Cancel auto-zero routine	 &  Press for approx. 5 seconds	Indicator lamp (page 19 (13)) "auto-zero" goes out
		Unit displays the current actual values

If a repeat auto-start / *auto-zero routine* is unsuccessful, contact the service department of Kendro Laboratory Products.

Error code request

The unit is equipped with an error diagnosis system.

This diagnosis system lets you detect and evaluate a fault during operation by means of specific codes.

If an error occurs within a control loop, the relevant display flashes to indicate this.







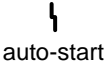
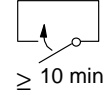
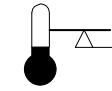
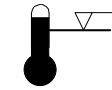
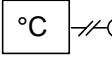
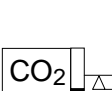

Press  (page 19 (18)) to display the error detected by the diagnosis system and to acknowledge the alarm.

When the error is cleared, the error message is automatically closed and the display stops flashing.

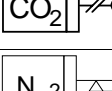

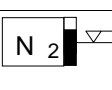
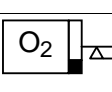
Exception: Error 502

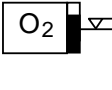
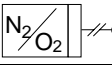
Instruction	Entry / Keys / Remarks	Display / Remarks / Status
Scan error code / Acknowledge acoustic alarm	 Hold down	Error code is displayed/acoustic alarm is acknowledged Display " - - - ": No error detected

6. OPERATE

ERROR CODES				
CODE		CAUSE	Error condition	POSSIBLE REMEDY
88	 auto-start	Error during auto-start	Measuring cell outside calibration range	Repeat the auto-start routine (refer to pages 23)
99	 ≥ 10 min	Unit doors are open	Doors are open for more than 10 minutes	Close the unit doors (refer to page 14) or just acknowledge acoustic alarm
100		Temperature below setpoint	Actual value < setpoint -0.5°C	Check the settings on the controller and Temperature Limit Controller (refer to pages 18 and 20)
101		Temperature above setpoint	Actual value > setpoint +1°C	Ambient temperature could be too high: check the circuit status of the door heater (refer to pages 15 and 31)
104		Temperature sensor faulty	Sensor broken/short-circuited	Contact the service department of Thermo Electron GmbH
200		CO ₂ below setpoint	Actual value < setpoint -1%	Check the gas supply for - cylinder content - inlet pressure - supply line and connection to unit Refer to page 12
201		CO ₂ above setpoint	Actual value > setpoint +1%	Check the gas supply for - inlet pressure Refer to page 12
204		CO ₂ measuring cell faulty	Sensor broken/short-circuited	Contact the service department of Thermo Electron GmbH
300		N ₂ below setpoint	Actual O ₂ value < setpoint -2% Gassing with N ₂	Check the gas supply for - gas cylinder content - inlet pressure - supply line and connection to unit Refer to page 13/14
301		N ₂ above setpoint	Actual O ₂ value > setpoint +2% Begasung mit N ₂	Check the gas supply for - inlet pressure Refer to page 13/14
302		O ₂ above setpoint	Actual O ₂ value < setpoint -2% Gassing with O ₂	Check the gas supply for - gas cylinder content - inlet pressure - supply line and connection to unit Refer to page 13/14
303		O ₂ above setpoint	Actual O ₂ value > setpoint +2% Gassing with O ₂	Check the gas supply for - inlet pressure Refer to page 13/14
304		O ₂ sensor faulty		Contact service
400		Relative humidity below setpoint	Actual value < setpoint -5%	Check the water reservoir Contact the service department of Thermo Electron GmbH if necessary
404		Relative humidity sensor faulty	Sensor faulty/short-circuited	Contact the service department of Thermo Electron GmbH
405		Evaporator faulty	95°C > Actual value > 620°C	Contact the service department of Thermo Electron GmbH

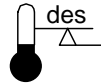
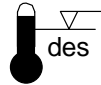
6. OPERATE

500		"des" temperature below setpoint	Actual value < 180°C -10°C	Repeat the disinfection process. Contact the service department of Thermo Electron GmbH if necessary.
501		"des" temperature above setpoint	Actual value > 180°C +10°C	Contact the service department of Thermo Electron GmbH.
502		Error during disinfection procedure	Power failure > 1 sec	Press the des button (Fig.4, (7)) to reset the error and repeat the disinfection procedure; check voltage supply for power failure.

A malfunction of the unit is not the only explanation for error codes 101, 201. They can also be displayed after a setpoint is decreased.

Example:

When operating the unit with the setpoint entered for 10% CO₂:
If the CO₂ setpoint is decreased to 5% CO₂, the unit cannot reach this lower CO₂ concentration quickly enough due to its tightness. Error 201 is displayed.

The designated error messages are displayed when:

- Setpoint < actual value.
- Setpointtemperatur ≤ ambient temperature + 5°C

To avoid this, open the doors for a short time. This also applies to the reduced temperature.

If these measures are unsuccessful or if errors with undefined codes occur, please notify our service department (refer to Appendix).

When requesting our service, please state the scanned error code.

6. OPERATE















Switching functions

Press  - Key (page 19 (17)) to select the individual switching functions as required.
The indicator lamp "control" (page 19 (16)) indicates when one of the switching functions specified below is selected:

- Acoustic alarm ON/OFF
- Humidification ON/OFF
- Manual zero calibration of CO₂ measuring system
- Setpoint lock-in ON/OFF
- Door heater ON/OFF

Switching function: acoustic alarm ON/OFF















Factory setting: acoustic alarm switched on.

Instruction	Entry / Keys / Remarks	Display / Remarks / Status
Select function level 1	 Press	Indicator lamp "control" flashes and current function level is indicated by a flashing display
	 or  Press	
Circuit status display and factory setting: Acoustic alarm ON	 Release and press again	 
Change circuit status: acoustic alarm OFF	 Press	 
Change circuit status: acoustic alarm ON	 Press	 
Exit function level	 Release	Actual temperature, CO ₂ , O ₂ and rel. humidity values are displayed again after 1 minute
	Press any setpoint key	Actual temperature, CO ₂ , O ₂ and rel. humidity values are displayed again immediately

6. OPERATE

Switching function: Humidification ON/OFF

Factory setting: Humidification switched on (set to 60 % rel. humidity).

Instruction	Entry / Keys / Remarks	Display / Remarks / Status
Select function level 2	 Hold down	Indicator lamp "control" flashes and current function level is indicated by the flashing display
	 or  Press	 °C
Display circuit status, factory setting: Humidification ON	 Release and press again	 °C  CO ₂
Change circuit status: Humidification OFF	 Press	 °C  CO ₂
Change circuit status: Humidification ON	 Press	 °C  CO ₂
Exit function level	 Press	Actual temperature, CO ₂ , O ₂ and rel. humidity values are displayed again after 1 minute
	Press any setpoint key	Actual temperature, CO ₂ , O ₂ and rel. humidity values are displayed again immediately













6. OPERATE

Switching function: Manual zero calibration of CO₂ measuring system



Recommendation: Check the CO₂ concentration, especially during long-term tests. If there is a large deviation ($\pm 0.5\%$) between the displayed actual value for CO₂ concentration and the nominal value, the measuring system can be recalibrated during operation.

Example: Display: 5.0 % CO₂
 Comparative measurement: 4.2 % CO₂

Instruction	Entry / Keys / Remarks	Display / Remarks / Status
Select function level 3	 Hold down	Indicator lamp "control" flashes and the current function level is indicated on the flashing display
	 or  Press	 °C
Display zero point	 Release and press again	 °C  CO ₂
Enter determined CO ₂ concentration	 or  Press	 °C  CO ₂
Start calibration process/exit function level	 Release	
	 Press	"CAL" is briefly displayed. The corrected actual value is then displayed















6. OPERATE

Switching function: Setpoint lock-in ON/OFF



To prevent unintentional or unauthorized modification of the setpoints for temperature, CO₂, O₂ and rel. humidity, the setpoints can be "locked in".

The setpoints cannot be changed until the interlock has been cancelled again.
Factory setting: setpoints unlocked.

Instruction	Entry / Keys / Remarks	Display / Remarks / Status
Select function level 4	 Hold down	Indicator lamp "control" flashes and current function level is indicated by flashing display
	 or  Press	 °C
Display circuit status, factory setting: setpoints released	 Release and hold down again	 °C  CO ₂
Change circuit status: locked setpoints	 Press	 °C  CO ₂
Change circuit status: Release setpoints	 Press	 °C  CO ₂
Exit function level	 Release	Actual temperature, CO ₂ , O ₂ and rel. humidity values are displayed again after 1 minute
	Press any setpoint key	Actual temperature, CO ₂ , O ₂ and rel. humidity values are displayed again immediately

6. OPERATE















Switching function: Door heater ON/OFF

To adapt the unit to the ambient temperature in the place of installation, the door heater can be switched on or off (see page 13 for example).



Condensation can occur inside the unit, especially on the glass door or glass screen, when the door heater is switched off.



Factory setting: door heater switched on.

Instruction	Entry / Keys / Remarks	Display / Remarks / Status
Select function level 5	 Hold down	Indicator lamp "control" flashes and the current function level is indicated by the flashing display
	 or  Press	
Display circuit status, factory setting: Door heater ON	 Release and hold down again	 
Change circuit status: Door heater OFF	 Press	 
Change circuit status: Door heater ON	 Press	 
Exit function level	 Release	Actual temperature, CO ₂ , O ₂ and rel. humidity values are displayed again after 1 minute
	Press any setpoint key	Actual temperature, CO ₂ , O ₂ and rel. humidity values are displayed again immediately

7. START-UP



The items specified in brackets refer to **Fig. 4 on page 15.**

Instruction	Entry / Keys / Remarks	Display / Remarks / Status
Open unit doors		
Remove transit restraints and accessories from inside the unit		
Carry out basic cleaning		
Water reservoir	Fill unit with water	-- observe max. level, use distilled or fully desalinated water
Switch on unit	Mains switch (8) = " I "	All display elements come on for approx. 15 seconds - auto-test of controller - O ₂ version: The O ₂ measuring system is started up automatically on completion of the auto test. Duration: approx. 5 min. O ₂ display reads "run"
Adjust setpoints	Control and display panel (A)	Refer to page 18-21
Set temperature protection device	Adjust Temperature Limit Controller (6)	Refer to page 18
Select switching function(s) as required	On control and display panel (refer to page 20 and 27 to 31)	
Activate auto-start	 &  Press Hold down for approx. 5 seconds	Indicator lamp "auto-start" flashes
Close all unit doors	Temperature displays "actual value" CO ₂ displays "0.0", O ₂ displays "21.0", rel. humidity displays "actual value" auto-start routine runs automatically. <ul style="list-style-type: none"> ■ Unit is set to entered temperature and relative humidity set points. ■ Relative humidity is built up. ■ When a constant temperature and relative humidity are reached, the CO₂ and O₂ measuring system is calibrated automatically. ■ Indicator lamp "auto-start" goes out. ■ "auto-zero" routine for determining reference values is executed. ■ Gas is admitted until the entered CO₂ / O₂ setpoints are reached. 	

8. OPERATION



Operating control

The microbiological safety of the unit is largely dependent on the proper conduct of the persons using the unit. Refer to the Appendix "Basic rules of sound microbiological engineering practice".

Be sure to comply with the instructions contained in this manual as well as all applicable regulations and directives in your country (FRG: ZH 1/119, ZH 1/342, ZH 1/343, ZH 1/598).

Before putting the unit into operation

- Put on all safety garments necessary to protect hands, face and body; remove jewelry.
- Disinfect and clean the chamber and fittings regularly. Only use lint-free materials to wipe surfaces clean.
- Do not use explosive disinfectants. When using alcoholic disinfectants, be sure they comply with all applicable regulations of your country (FRG: ZH 1/598).

During operation

Correct loading determines the temperature conditions in the chamber. If large objects or auxiliaries are placed inside the chamber, this can impair the temperature distribution in the unit.

When loading the unit, do not arrange articles too close to one another on the shelves (use only approx. 70 % of surface area) in order to avoid impairing air circulation and ensure constant heat flow.



Do not impair temperature distribution. This is mainly caused by the following:

- Covering the air vents.
- Voluminous objects or apparatus.
- Equipment releasing large amounts of heat.



Do not change the settings of the temperature protection devices as this will render load protection ineffective.

Operating interruptions

If operations are interrupted, make sure that no contamination hazards can occur.

- Remove, disinfect and clean any objects or auxiliaries put into the unit.
- Disinfect and clean the chamber.
- Disinfect and remove any residues.
- Disinfect the unit with hot air (disinfection routine).

9. SHUTDOWN



The unit may only be shut down by qualified staff trained to operate this equipment.
The unit must not present any risk of contamination after shutdown.

- Shut off the gas supply.
- Remove, disinfect and clean any objects or auxiliaries put into the unit.
- Disinfect and clean the chamber. Leave the unit doors open until the chamber is dry.
- Disinfect the unit with hot air (disinfection routine).
- Set the mains switch to "0" and disconnect the power plug.

10. MAINTENANCE

Cleaning / Disinfection



Be sure to disinfect the unit in compliance with the applicable regulations in your country (FRG: ZH 1/598).



The chamber and fittings are decontaminated through hot air disinfection at 180°C. The sensors can be left inside the unit during the disinfection process. Do not spray the O₂ / rel. humidity sensors (porous sintered material) with disinfectant.

Recommended disinfectant:

A surface disinfectant recommended by Thermo Electron Corporation can be ordered under following part numbers:

- Spray bottle, 250 ml Part No.: 50052425
- Refill bottle, 500 ml Part No.: 50051939



NOTE - Description disinfectant:

Details for efficiency and approvals are available on request.

Order Disinfection:

- Remove samples, cultures, etc., from the unit.
- Switch off the unit.
- Remove shelves and carrier racks.
- Remove safety device from the rear panel of the inner vessel with tools (e.g. screw driver) and detach them by lifting it up.
- Clean inner housing, shelves and carrier racks using a warm, skin-sensitive detergent ("Pril") and allow them to dry completely. Do not wet sensors (4, 6, 8) with liquids and disinfectants.

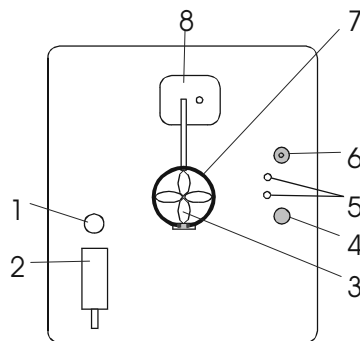

- 1.) Lead-through and pressure compensation vent
- 2.) Steam outlet: Do not fill unit with any liquids - only clean the surface
- 3.) Recirculated air blower
- 4.) O₂ sensor (optional)
- 5.) Pt 100 temperature sensors
- 6.) Relative humidity sensor.
- 7.) Tubular radiator for disinfection
- 8.) CO₂ measuring cell

Fig. 8: Rear wall of inner vessel

- Also clean glass door and seal with detergent and allow them to dry completely.
- Then spray surfaces and seals with surface disinfectant and allow it to react in accordance with the manufacturer's instructions for use.
- Then rinse surfaces with distilled water several times until all traces of disinfectant have been removed. Collect the washings.
- The surfaces of the unit can also be re-rinsed or sprayed with a 70% by vol. alcohol solution (analytically pure isopropanol) if required.

10. MAINTENANCE



Attention: Be sure to comply with the safety instructions and applicable regulations in your country!

Alcohols or solutions with an alcohol content of greater than 10% can ignite or form explosive gaseous mixtures when they come into contact with air and should therefore only be used in well-ventilated places. Do not expose to naked flame.

*Equipment and component parts cleaned using alcohol or alcoholic solutions must not be exposed to naked flames or other possible hazard sources. **Wait until dry before use!***

- Install the parts in the reverse order of removal as appropriate.
- Disinfect the unit with hot air at 180°C (disinfection routine).
- After disinfection, put the unit back into operation as described and always check that it is safe to operate prior to loading.

Testing



The serviceability and safety of the unit are only guaranteed if the necessary testing, maintenance and repair work is carried out by the Thermo Electron GmbH department or by staff authorized by us.

The unit should be checked for safety, leakproofing and serviceability at least once a year.

Equipment log book

We recommend you keep an equipment log book (refer to APPENDIX).

Keep a record of inspection and tests, calibration work and any major work carried out on the unit (e.g. maintenance work, agents loaded, etc.) in this log book.

Replacement of electrical parts



Work on electrical components of the unit may only be carried out by Heraeus service department personnel and when the unit is in a deenergized state (disconnected from the mains supply).

Only use original replacement parts approved by Thermo Electron GmbH.

The sensors may only be replaced by authorized personnel of the operator.

11. AUTHORIZED REPLACEMENT PARTS AND ACCESSORIES

The safety and serviceability of the equipment are only guaranteed if the approved original replacement parts specified below are used.

Use of other parts presents unknown risks and is not approved under any circumstances.

Replacement part	Type	Order No.
Instruction manual		50 079 019
Hose set for connecting unit to gas supply		50 062 701
Unit foot, upper part		50 044 921
Foot, height-adjustable, lower part		50 029 587
2 support brackets		50 011 380
Shelf		50 069 923
Shelf, divided		50 069 921
Glass door		50 025 445
Gasket for iner-casing front		50 048 705
Glass door for gas-tight glass screen, left		50 030 020
Glass door for gas-tight glass screen with feed-trough, left		50 030 021
Glass door for gas-tight glass screen, right		50 030 022
Seal for glass door for gas-tight glass screen		50 041 536
Filler canister		50 029 126
Equipment fuse	T 6,3 A (slow-blow)(2 pcs.)	03 002 641
Sealing plug for feed-through (without hole)		03 669 008
Sealing plug for feed-through (with hole)		50 029 827
Subframe, 300 mm high		50 031 348
Subframe, 780 mm high		50 029 597
Pressure reducer for CO ₂		03 429 937
Pressure reducer for N ₂		03 429 942
Pressure reducer for O ₂		03 429 943

12. TECHNICAL SPECIFICATIONS

TECHNICAL SPECIFICATIONS			
	UNITS:	VALUE:	
MECHANICAL:			
Outer dimensions (W x H x D)	mm	920 x 855 x 775	
Inner dimensions (W x H x D)	mm	607 x 669 x 585	
Chamber volume	l	approx. 220	
Divided Shelves (W x D)	mm	260 x 500	
Quantity included in scope of supply	pcs	3	
Max. quantity	pcs	12	
Max. surface load	kg	10 per shelf	
Max. gross load of unit	kg	30	
Weight of unit excluding accessories	kg	107 (net)	
THERMAL:			
Ambient temperature range	°C	+18 ... +30	
Temperature control range	CO ₂ - equipment CO ₂ / O ₂ - equipment	°C °C	Ambient temp.+5 ... +50 +7 ... +50
Temperature deviation, temporal (DIN 12 880, Part 2)	K	< ± 0.1	
Temperature deviation, spatial (DIN 12 880, Part 2)	at: 37°C 50°C	K K	< ± 0.5 < ± 0.7
Heating-up time with auto-start (ambient temperature 22°C, unit empty) to: 37°C	h	approx. 5	
Cooling time (ambient temperature 22°C unit empty) from: 37 °C to 25°C	h	approx. 5	
Heat release into surroundings at 37°C / 95% rel. humidity	kWh/h	approx. 0,16	
Heat release into surroundings at 50°C / 95% rel. humidity	kWh/h	approx. 0,22	
Heat release into surroundings during disinfection process	kWh/h	approx. 0,59	
Recovery time at: 37°C / 5% CO ₂ 95% rel. humidity / 7% O ₂ (closing the doors after they have been open for 30 s)	Temperature CO ₂ Humidity O ₂	min min min min	≤ 3 ≤ 2 (max. 1,4 % / min) ≤ 9 ≤ 15

12. TECHNICAL SPECIFICATIONS

TECHNICAL SPECIFICATIONS		
	UNITS:	VALUE:
Humidification		
Water quality min. - max. level	l	Distilled or fully desalinated 2.2
Water demand to humidify: from 40 % rel. humidity to 95 % rel. humidity	ml	17
Water consumption	ml/h	10
Total capacity	l	4.7
Measuring range and Setting range*	% r.H.	60 ... 95
Control accuracy	% r.H.	± 1
GAS ENGINEERING		
Carbon dioxide (CO ₂) Oxygen (O ₂) Nitrogen (N ₂) Purity Inlet pressure	% bar	99.5 0.8 up to max. 1
Measuring range and Setting range	% CO ₂	0 ... 20
Control accuracy	% CO ₂	± 0,1
ELECTRICAL:		
Rated voltage Rated frequency	V Hz	1/PE AC, 230 or 1/PE AC, 120 50/60 50/60
Radio interference suppression (DIN VDE 0875)		Interference suppression level N
Type of enclosure (DIN 40050)		IP 20
Protection class		I
Overvoltage category (IEC 1010)		II
Degree of soiling (IEC 1010)		2
Rated current	A	5,2 or 10,0
Fuse protection: Fuse Circuit-break switch		T 16 A slow-blow G 16
Rated power consumption during incubation/disinfection	kW	1.2 / 1.2
MISCELLANEOUS		
Sound pressure level (DIN 45635 Part 1)	dB (A)	< 50
max. r.H of the ambience	% r. H	80
Height	m NN	2.000

* Under some circumstances, eg. when working with culture vessels without covers, the control range will be restricted to 90-95% since below this level evaporation of the medium will lead to an increase of the relative humidity in the chamber.

13. MATERIALS USED / DISPOSAL

Components	Material
Outer housing	Galvanized sheet steel, painted to RAL 9002
Inner vessel, shelves	Stainless steel, material No. 1.4301
Glass pane	Sodium silicate glass
Door seal of unit	Magnetic core sheathed in soft PVC
Glass door seal	Tempered silicon
Thermal insulation	PU foam sheet (CFC) incorporating non-woven needled glass fibre quilt (binder-free)
Control and display membrane	Polyethylene
Heating systems	Silicon-sheathed resistance heating conductor and tubular heater
Leads	Plastic-sheathed copper strands
Other components	Sheathed electrical components coated in various plastics partly mounted on printed circuit boards bonded with epoxy resin

Disposal

WEEE Compliance:

This product is required to comply with the European Union's Waste Electrical & Electronic Equipment (WEEE) Directive 2002/96/EC. It is marked with the following symbol:



Thermo Electron Corporation has contracted with one or more recycling/disposal companies in each EU Member State, and this product should be disposed of or recycled through them. Further information on Thermo Electron's compliance with these Directives, the recyclers in your country, and information on Thermo Electron products which may assist the detection of substances subject to the RoHS Directive are available at www.thermo.com/WEEERoHS.

14. GAS CONSUMPTION

Gas consumption during operation of "BBD 6220 gassed incubator"

Gas consumption corresponds to the gas quantity released at the back of the unit which has to be discharged safely into the outside air by ventilating the placement area.

Gasing with CO2

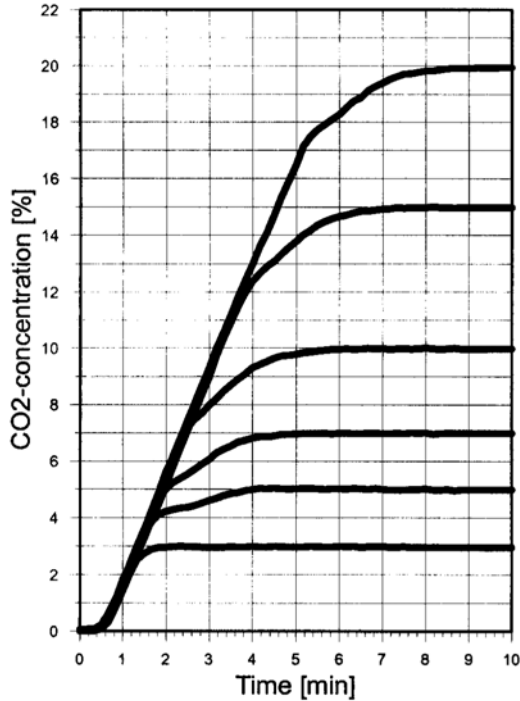

Amt. of gas supplied: 8 l/h
Gas inlet pressure: 1 bar

Gas consumption CO2

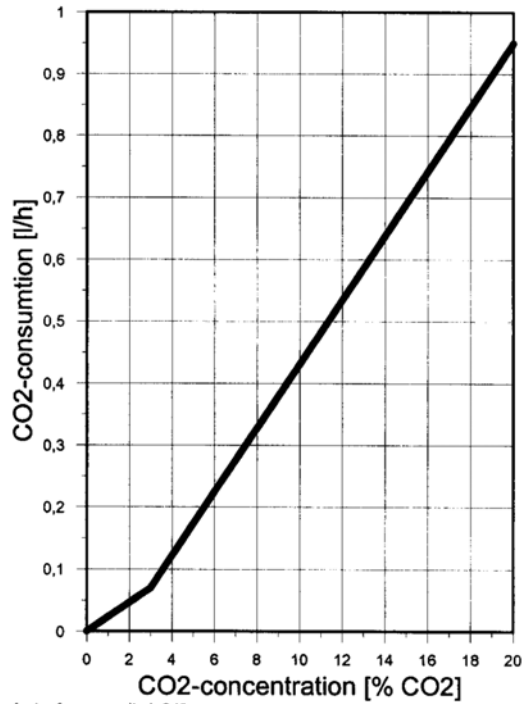

Amt. of gas supplied: 8 l/h
Gas inlet pressure: 1 bar

Gasing with Oxygen (O2) / Nitrogen (N2)

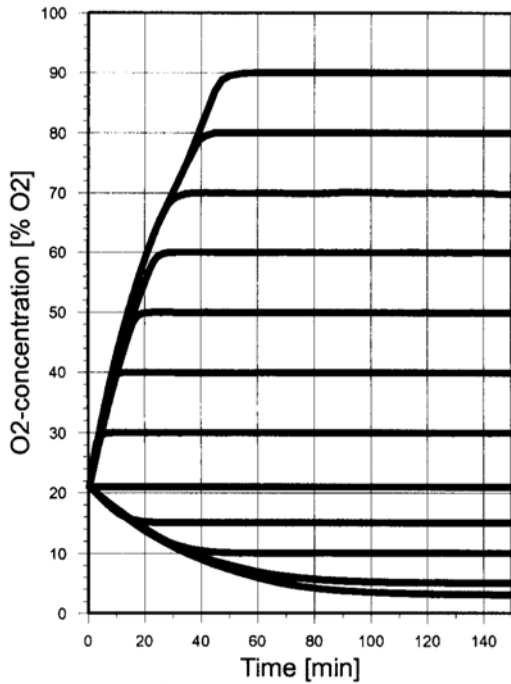

Amt. of gas supplied: O₂ 9,8 l/min
N₂ 7,4 l/min
Gas inlet pressure: 1 bar

Gas consumption of N2/O2

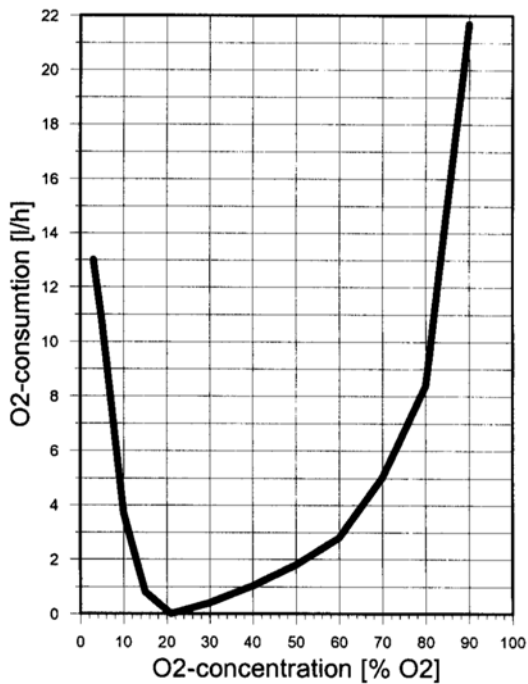

Amt. of gas supplied: O₂ 9,8 l/min
N₂ 7,4 l/min
Gas inlet pressure: 1 bar

PH-VALUE OF CULTURE MEDIA

pH-value of culture media
Dependency on the CO₂-concentration

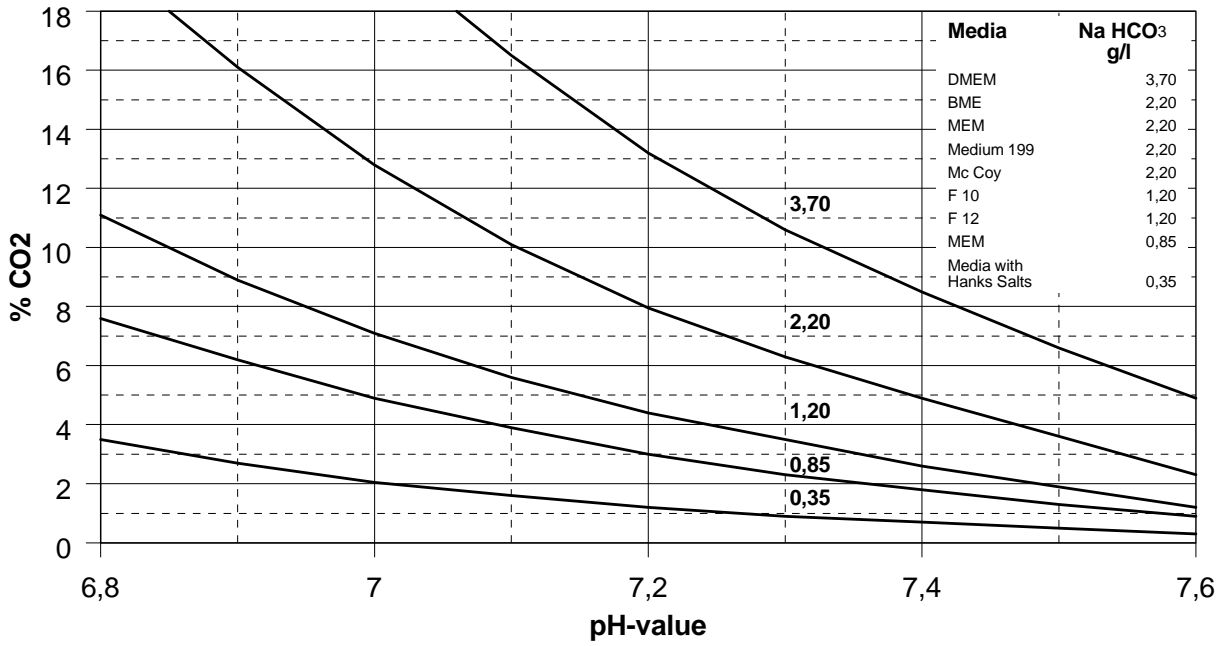

BASIC RULES OF SOUND MICROBIOLOGICAL ENGINEERING PRACTICE *

General rules

- Keep windows and doors in the working areas closed while work is in progress.
- Do not consume drinks, food or smoke in the working areas. Do not keep foodstuffs in the working areas.
- Lab coats or other protective garments must be worn in the working area.
- Oral pipetting is prohibited. Use pipetting aids.
- Only use needles and syringes if absolutely necessary.
- With all manipulators, be sure to avoid aerosol formation as far as possible.
- On completion of work and before leaving the working area, clean hands thoroughly. Disinfect and re-moisturize hands if necessary.
- Keep working areas clean and tidy. Only equipment and materials actually required should be on the work-tops. Keep stocks in the areas or cabinets provided for them only.
- Regularly check the identity of the biological agents used if this is a requirement for hazard potential assessment. The length of the interval between checks should be set according to hazard potential.
- With regard to the handling of biological agents, employees must be issued with verbal instructions relating to the workplace before commencing work. These instructions must be re-issued at least once annually thereafter.
- Employees inexperienced in the fields of microbiology, virology or cellular biology must be given thorough instructions and be supervised.
- Vermin and pests must be combatted regularly if necessary.

Handling of pathogens

Also heed the following basic rules regarding the handling of pathogens:

- Disinfect all workplaces on a daily basis. It may be necessary to switch disinfectants as a precaution against resistant germs.
- Do not wear protective garments outside the working areas.
- Contaminated equipment must be autoclaved or disinfected prior to cleaning.
- Waste containing pathogens must be collected safely and rendered harmless through autoclaving or disinfection.
- If infectious substances are spilt, the contaminated area must be closed off immediately and disinfected.
- If work is conducted using human pathogens against which an effective antidote is available, all employees who are not yet immune must be vaccinated and checked regularly for immunity in the appropriate manner.
- The health of employees must be monitored by medical check-ups, i.e. employees must undergo an initial check-up before commencing work and subsequent annual check-ups. Medical check-ups should be conducted in accordance with the applicable employers' liability insurance association guidelines, in particular G 24, "Skin diseases", and G 42, "Infectious diseases". As generally recognized rules of industrial medicine, they enable the doctor to assess, evaluate and record the results of examinations according to the same criteria.

* Apply to cell cultures as appropriate

Source: specification B003, edition 1/92 - ZH 1/343 of the Berufsgenossenschaft der chemischen Industrie (employer's liability insurance association for the chemicals industry), Jedermann Verlag, Dr. Otto Pfeffer OHG, PO box 103140, 69021 Heidelberg

BASIC RULES OF SOUND MICROBIOLOGICAL ENGINEERING PRACTICE *

- Potentially hazardous, genetically engineered organisms, viruses and subviral agents must be handled in accordance with employers' liability insurance association guideline G 43 entitled "Biotechnology".
- Instructions for administering first aid in the event of accidents involving pathogenic microorganisms and viruses must be immediately to hand in the working area. The person in charge must be notified of all accidents immediately.

Depending on hazard potential, it may be necessary to take further safety precautions:

- Use of class I, class II (type-approved)** or class III safety workbenches (air flow pointing away from experimenter).
- Restricting and supervising access to specific areas.
- Use of special protective garments and breathing apparatus.
- Disinfection of all materials containing pathogenes before they leave the worktop.
- Maintaining a partial vacuum in the working area.
- Reducing the germ count in the exhaust air by taking appropriate measures, such as using high-performance suspended-matter filters.

Handling of human- and animal-pathogenic biological agents

The following general rules also apply to the handling of human- and animal-pathogenic biological agents:

- Human-pathogenic biological agents may only be handled with approval under the terms of the Federal Epidemics Act.
- Approval under the terms of the Federal Animal Epidemics Act and the Ordinance concerning Agents of Animal Epidemics is required to handle agents of animal epidemics.
- Pregnant women or nursing mothers are not permitted to handle infectious and human-pathogenic biological agents or materials containing these agents.

* Apply to cell cultures as appropriate

**Manufacturers' certificates can be found in the memoranda of the Berufsgenossenschaft Chemie (employer's liability insurance association for chemicals) entitled "Sichere Chemiewerk" (Safe chemistry) and the Berufsgenossenschaft für Gesundheitsdienst und Wohlfahrtspflege (employer's liability insurance association for health service and welfare). They can also be obtained on request from the test centre of the expert committee on "Health care and welfare" (Berufsgenossenschaft für Gesundheitsdienst und Wohlfahrtspflege, Prüfstelle des Fachausschusses "Gesundheitsdienst und Wohlfahrtspflege, Pappelallee 35-37, 22089 Hamburg, Germany).

Source: specification B003, edition 1/92 - ZH 1/343 of the Berufsgenossenschaft der chemischen Industrie (employer's liability insurance association for the chemicals industry), Jedermann Verlag, Dr. Otto Pfeffer OHG, PO box 103140, 69021 Heidelberg

Thermo
ELECTRON CORPORATION

Internet: www.thermo.com